

BOSE[®]



SoundTouch[®] SA-5
amplifier



Owner's Guide • គំរូដ៏ដ្ឋង់ • 사용자 안내서
用戶指南 • 使用者指南 • دليل المالك

Important Safety Instructions

Please read the owner's guide and save it for future reference.

All Bose products must be used in accordance with local, state, federal, and industry regulations.



The lightning flash with arrowhead symbol within an equilateral triangle alerts the user to the presence of uninsulated, dangerous voltage within the system enclosure that may be of sufficient magnitude to constitute a risk of electrical shock.



The exclamation point within an equilateral triangle, as marked on the system, is intended to alert the user to the presence of important operating and maintenance instructions in this owner's guide.

WARNINGS:

- To reduce the risk of fire or electrical shock, do not expose the product to rain or moisture.
- Do not expose this apparatus to dripping or splashing. Do not place objects filled with liquids, such as vases, on or near the apparatus. As with any electronic products, use care not to spill liquids into any part of the system. Liquids can cause a failure and/or a fire hazard.
- Do not place any naked flame sources, such as lighted candles, on or near the apparatus.



WARNING: Contains small parts which may be a choking hazard. Not suitable for children under age 3.



This symbol means the product must not be discarded as household waste, and should be delivered to an appropriate collection facility for recycling. Proper disposal and recycling helps protect natural resources, human health and the environment. For more information on disposal and recycling of this product, contact your local municipality, disposal service, or the shop where you bought this product.

CAUTIONS:

- The product must be used indoors. It is neither designed nor tested for use outdoors, in recreation vehicles, or on boats.
- Make no modifications to the system or accessories. Unauthorized alterations may compromise safety, regulatory compliance, and system performance.

Important Safety Instructions

NOTES:

- Where the mains plug or appliance coupler is used as the disconnect device, such disconnect device shall remain readily operable.
- The product label is located on the bottom of the product.
- Refer to your local building codes for wire types suitable for your application.
- Changes or modifications not expressly approved by Bose Corporation could void the user's authority to operate this equipment.
- Operate this product within the temperature range of 32° F to 104° F (0° C to 40° C).

Important Safety Instructions

1. Read these instructions.
2. Keep these instructions.
3. Heed all warnings.
4. Follow all instructions.
5. Do not use this apparatus near water or moisture.
6. Clean only with a dry cloth.
7. Do not block any ventilation openings. Install in accordance with the manufacturer's instructions.
8. Do not install near any heat sources such as radiators, heat registers, stoves, or other apparatus (including amplifiers) that produce heat.
9. Protect the power cord from being walked on or pinched particularly at plugs, convenience receptacles, and the point where they exit from the apparatus.
10. Use only attachments/accessories specified by the manufacturer.
11. Unplug this apparatus during lightning storms or when unused for long periods of time.
12. Refer all servicing to qualified personnel. Servicing is required when the apparatus has been damaged in a way, such as power-supply cord or plug is damaged, liquid has been spilled or objects have fallen into the apparatus, the apparatus has been exposed to rain or moisture, does not operate normally, or has been dropped.



Only suitable for use at areas with altitude less than 2000m.

Regulatory Information

Important USA and Canada compliance Information

- This device complies with part 15 of the FCC rules and Industry Canada license-exempt RSS standard(s). Operation is subject to the following two conditions: (1) This device may not cause harmful interference, and (2) this device must accept any interference received, including interference that may cause undesired operation.
- This equipment complies with FCC and Industry Canada radiation exposure limits set forth for an uncontrolled environment. This equipment should be installed and operated with a minimum distance of 8 inches (20 cm) between radiator and your body. This transmitter must not be co-located or operating in conjunction with any other antenna or transmitter.

CAN ICES-3 (B)/NMB-3(B)

This Class B digital apparatus complies with Canadian ICES-003.

 Bose Corporation hereby declares that this product is in compliance with the essential requirements and other relevant provisions of Directive 1999/5/EC and all other applicable EU directive requirements. The complete Declaration of Conformity can be found at www.Bose.com/compliance

Information about products that generate electrical noise

This equipment has been tested and found to comply with the limits for a Class B digital device, pursuant to Part 15 of the FCC Rules. These limits are designed to provide reasonable protection against harmful interference in a residential installation. This equipment generates, uses, and can radiate radio frequency energy and, if not installed and used in accordance with the instructions, may cause harmful interference to radio communications. However, there is no guarantee that interference will not occur in a particular installation. If this equipment does cause harmful interference to radio or television reception, which can be determined by turning the equipment off and on, the user is encouraged to try to correct the interference by one or more of the following measures:

- Reorient or relocate the receiving antenna.
- Increase the separation between the equipment and receiver.
- Connect the equipment into an outlet on a circuit different from that to which the receiver is connected.
- Consult the dealer or an experienced radio/TV technician for help.

This device when operating in the 5150 to 5250 MHz band is for indoor use only to reduce the potential for harmful interference to co-channel mobile satellite systems.

Date of manufacture: The first bolded digit in the serial number indicates the year of manufacture; "5" is 2005 or 2015.

China Importer: Bose Electronics (Shanghai) Company Limited, Part C, Plan 9, No. 353 North Riyang Road, China (Shanghai) Pilot Free Trade Zone.

EU Importer: Bose GP, Castleblayney Road, Carrickmacross, County, Monaghan, Ireland.

Taiwan Importer: Bose Taiwan Branch, 9F-A1, No.10, Section 3, Minsheng East Road, Taipei City 104, Taiwan.

Regulatory Information

Names and Contents of Toxic or Hazardous Substances or Elements

Part Name	Toxic or Hazardous Substances and Elements					
	Lead (Pb)	Mercury (Hg)	Cadmium (Cd)	Hexavalent (CR(VI))	Polybrominated Biphenyl (PBB)	Polybrominated diphenylether (PBDE)
PCBs	X	O	O	O	O	O
Metal parts	X	O	O	O	O	O
Plastic parts	O	O	O	O	O	O
Speakers	X	O	O	O	O	O
Cables	X	O	O	O	O	O

This table is prepared in accordance with the provisions of SJ/T 11364.

O: Indicates that said hazardous substance contained in all of the homogeneous materials for this part is below the limit requirement of GB/T 26572.

X: Indicates that said hazardous substance contained in at least one of the homogeneous materials used for this part is above the limit requirement of GB/T 26572.

Please complete and retain for your records

The serial and model numbers can be found on the bottom of the system.

Serial number: _____

Model number: _____

Purchase date: _____

We suggest you keep your receipt with this owner's guide.

App Store is a service mark of Apple Inc.

Amazon, Kindle and Fire are trademarks of Amazon, Inc. or its affiliates.

Android and Google Play are trademarks of Google Inc.

The *Bluetooth*® word mark and logos are registered trademarks owned by *Bluetooth* SIG, Inc. and any use of such marks by Bose Corporation is under license.



iHeartRadio is a registered trademark of iHeartMedia, Inc.

This product is protected by certain intellectual property rights of Microsoft. Use or distribution of such technology outside of this product is prohibited without a license from Microsoft.

iTunes is a trademark of Apple Inc., registered in the U.S. and other countries.

This product incorporates Spotify software which is subject to 3rd party licenses found here: www.spotify.com/connect/third-party-licenses.

Spotify is a registered trademark of Spotify AB.

SoundTouch and the wireless note design are registered trademarks of Bose Corporation in the U.S. and other countries.

Wi-Fi is a registered trademark of Wi-Fi Alliance®.

Windows is a registered trademark of Microsoft Corporation in the United States and other countries.

© 2015 Bose Corporation. No part of this work may be reproduced, modified, distributed, or otherwise used without prior written permission.

Contents

SoundTouch®

About your SoundTouch® SA-5 amplifier	8
System benefits.....	8
Hardware features.....	8
SoundTouch® app	8

Setting up the System

Unpacking the system.....	9
Installing the amplifier.....	10
Installation guidelines	10
Speaker wire recommendations.....	10
Placing the speakers.....	10
Connecting the speakers to the amplifier	11
Connecting one pair of speakers	11
Connecting two pairs of speakers	13
Connecting the system to power	14

Setting up SoundTouch®

Adding the system to your Wi-Fi® network.....	15
Download and install the SoundTouch® app.....	15
Connect the system to your home Wi-Fi® network	15
Adding the system to an existing SoundTouch® account	16
Connecting the system to a new network	16

Using the System

Using the SoundTouch® app	17
<i>Bluetooth</i> ® wireless technology	17
Getting help.....	17
Controlling the system from another smartphone, tablet or computer	17
Understanding the Wi-Fi® indicator	18

Personalizing your Presets

How Presets work.....	19
What you need to know.....	19
Playing a Preset	19
Setting a Preset	19

Care and Maintenance

Disabling Wi-Fi® capability	20
Re-enabling Wi-Fi® capability	20
Resetting the system	20
Troubleshooting	21
Overload protection	22
Cleaning.....	22
Customer service.....	22
Limited warranty information.....	23
Technical information.....	23

Appendix A: Connector Panel

Connectors.....	24
-----------------	----

Appendix B: Wall Mounting Instructions

Mounting hardware specifications	25
Mounting the bracket to the wall	26
Attaching the amplifier to the mounting bracket.....	27

Appendix C: Using a Computer for Setup

Important setup information	28
Using a desktop computer for setup	28
Setting up the system using a computer	28

About your SoundTouch® SA-5 amplifier

Your SoundTouch® amplifier is an elegant way to bring clear, room-filling sound streamed wirelessly into any room or outdoor space over your home Wi-Fi® network. With SoundTouch®, you can stream Internet radio, music services, and your music library.

If you have Wi-Fi at home, you're ready to enjoy your favorite music in any room you want.

System benefits

- Enjoy wireless access to Internet radio, music services and your music library.
- Access your favorite music easily with your personalized Presets.
- Wireless setup using your smartphone or tablet.
- Works with your existing home Wi-Fi network.
- Stream music from *Bluetooth*® devices.
- Free SoundTouch® app for your computer, smartphone or tablet.
- Simply add additional systems at any time for a multi-room listening experience.
- Wide selection of Bose® audio systems lets you choose the right solution for any room.

Hardware features

- Connects to your choice of indoor or outdoor speakers for powerful sound anywhere around your home (amplifier must remain inside and dry).
- Bose® proprietary signal processing automatically adjusts the tonal balance, enabling full, rich lows at nearly all listening levels.
- Ethernet connector enables wired access to your home network.
- Two terminal connectors enable you to connect up to two pairs of speakers.
- Three AUX IN connectors enable playback from media players.

SoundTouch® app

- Set up and control your system from your smartphone, tablet or computer.
- Use the SoundTouch® app to easily personalize Presets to your favorite music.
- Explore Internet radio, music services and your music library.
- Pair, connect and play audio from *Bluetooth* devices.
- Set the output of the amplifier to Stereo (default) or Mono.
- Rename the AUX IN connectors to easily identify connected devices.
- Adjust the system's bass level.
- Manage system settings.

Unpacking the system

Carefully unpack the carton and confirm that the following parts are included:



SoundTouch® SA-5 amplifier

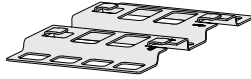

Mounting bracket



Mounting hardware



AC (mains) power cord



USB cable (computer setup only)

Save the carton and packing materials for transporting or storing the system.

CAUTION: To avoid danger of suffocation, keep the plastic bags out of the reach of children.

- i** The amplifier includes the appropriate AC (mains) power cord for your region. Use only the supplied AC (mains) power cord. If it does not fit your AC (mains) power outlet, **DO NOT** alter the plug in any way. Contact Bose customer service for assistance.

Note: If part of the system is damaged, do not use it. Contact your authorized Bose dealer or Bose customer service. Refer to the quick start guide in the carton for contact information.

Setting up the System

Installing the amplifier

Place the amplifier on a sturdy surface, close to an AC (mains) power source.

Tip: For wall mounting instructions, see page 25.

The amplifier does not need to be close to your speakers.

Installation guidelines

Amplifier Placement	<ul style="list-style-type: none">Place the amplifier on a shelf or mount it on a wall.Install the amplifier indoors, close to an AC (mains) power outlet. <p>CAUTIONS:</p> <ul style="list-style-type: none">Place the amplifier in an area where the maximum ambient temperature is less than 104°F (40°C).For optimum performance, place the amplifier in a well-ventilated area.DO NOT place the amplifier in a completely enclosed area. If adequate ventilation is not provided, performance of the system may be reduced.Place the amplifier with a minimum of 3 in. (75 mm) of ventilation around it.Do not stack multiple amplifiers on top of each other. If using multiple amplifiers, place them side by side.
Wall Mounting	<ul style="list-style-type: none">Use the provided mounting bracket and hardware (see page 25).Vertical mounting: attach the amplifier to the bracket with the Wi-Fi® indicator at the bottom; connector panel at the top.Horizontal mounting: attach the amplifier to the bracket with connector panel on the left or right.DO NOT mount the amplifier on the ceiling.
Speaker Connections	<p>CAUTIONS:</p> <ul style="list-style-type: none">Use only unpowered speakers. DO NOT connect any make or model of powered speakers. Doing so may cause damage to the equipment.One pair of speakers requires 4 ohm minimum each.Two pairs of speakers require 8 ohm minimum each.

Speaker wire recommendations

Maximum Length	Gauge
30 ft. (9 m)	18 (0.82 mm ²)
45 ft. (14 m)	16 (1.3 mm ²)
70 ft. (21 m)	14 (2.0 mm ²)

Placing the speakers

Place the speakers in their permanent location before connecting the speaker wires to the amplifier.

Connecting the speakers to the amplifier

After you place your speakers, connect the speaker wires to the amplifier. See “Installation guidelines” on page 10.

Speaker wires consist of two insulated wires:

- The marked wire (stripes, ribbing or color) connects to the positive (+) terminal.
- The plain wire connects to the negative (-) terminal.

Connecting one pair of speakers

To connect two pairs of speakers, see page 13.

1. Make sure the amplifier is not plugged into an AC (mains) power source.
2. Remove a terminal block connector from the **SPEAKERS OUT** connector.
3. Connect the speaker wires:
 - A. Insert the left speaker's marked wire into the **+ L** positive terminal and the plain wire into the **L -** negative terminal.
 - B. Insert the right speaker's marked wire to the **+ R** positive terminal and the plain wire to the **R -** negative terminal.
4. Secure the wires into the terminals using a small, flat-head screwdriver to tighten the screws on the terminals

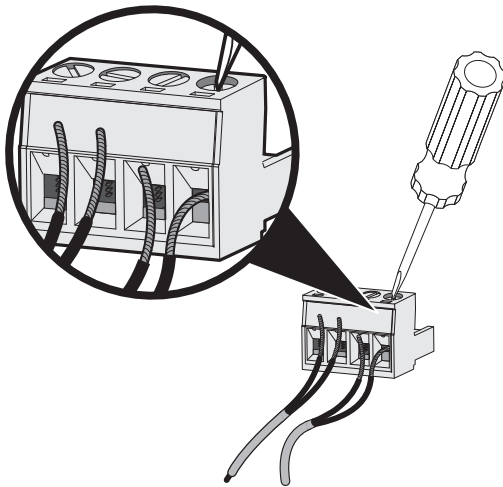

Setting up the System

5. Reinsert the terminal block connector into the **SPEAKERS OUT** connector.

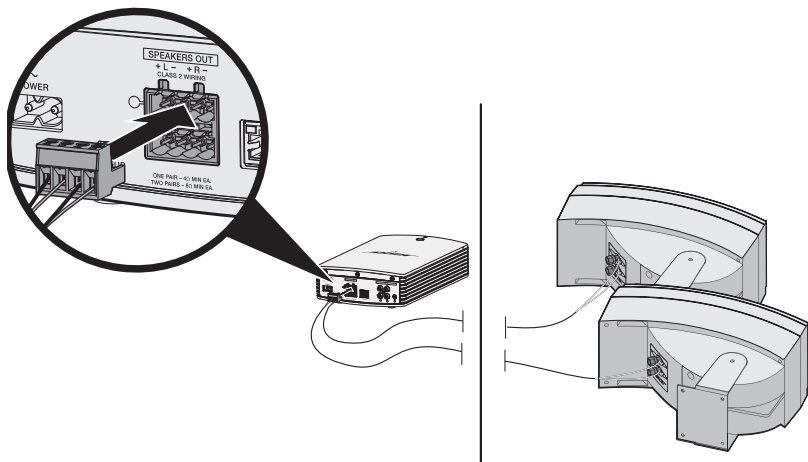

6. Follow the operating instructions for your unpowered speakers to connect the other end of the speaker wires to the speakers.

Note: Make sure to connect the marked wires to the positive terminals.

Tip: Use a silicone caulking material such as RTV adhesive (available at hardware stores) to protect the wiring at the outdoor speaker connections.

Connecting two pairs of speakers

You can connect two pairs of speakers to the amplifier for full sound in a large space or to play the same audio in different rooms.

Each pair of speakers requires a minimum 8 ohms nominal impedance.

Follow the instructions in “Connecting one pair of speakers” on page 11, except connect two pairs of speakers to the terminal blocks:

- Connect one pair of speakers to terminal block **A**.
- Connect the second pair of speakers to terminal block **B**.

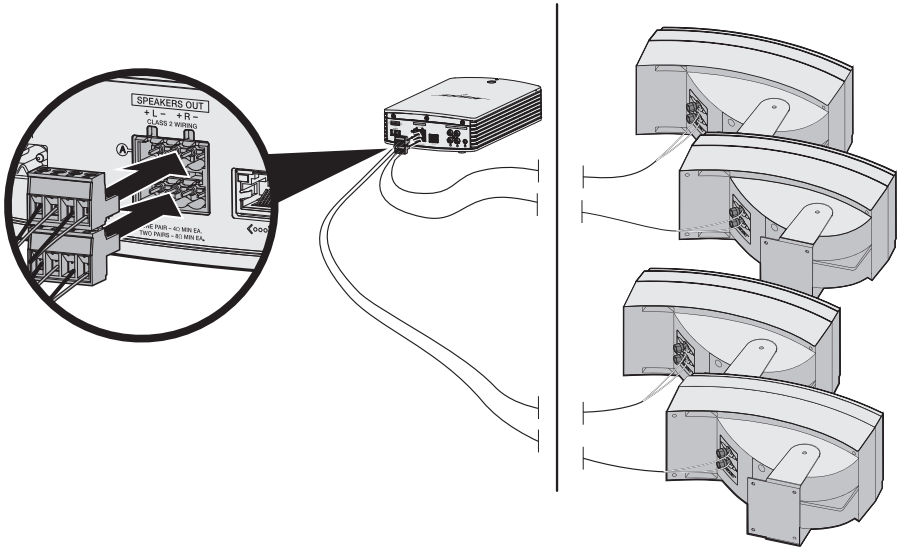

Setting up the System

Connecting the system to power

Connect the system to power after you connect the speaker wires to the amplifier.

1. Plug the power cord into the **POWER** connector on the amplifier.
2. Plug the other end of the power cord into an AC (mains) power outlet.

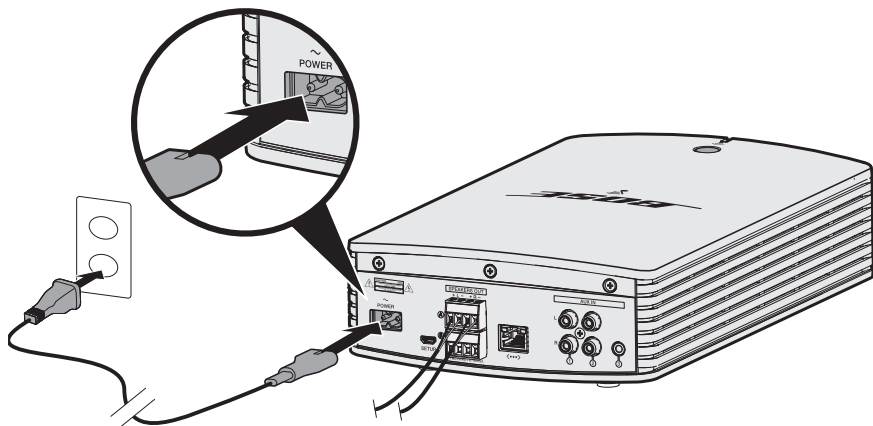

Adding the system to your Wi-Fi® network

After you connect the system to power, you must download and install the SoundTouch® app onto a smartphone or tablet that is connected to your network. The app guides you through connecting the system to your network.

Note: If you do not have a smartphone or tablet, you can use a computer for setup (see page 28).

Download and install the SoundTouch® app

If this is your first time setting up a SoundTouch® system, you must install the app. On your smartphone or tablet, download the **Bose SoundTouch® controller app**.



**Bose® SoundTouch®
controller app**

- iOS users: download from the App Store
- Android™ users: download on the Google Play™ store
- Amazon Kindle Fire users: download from the Amazon Appstore for Android

Connect the system to your home Wi-Fi® network

After you install the app, add the system to your network:

1. On your smartphone or tablet, select  to open the app.
The app guides you through connecting the system to your Wi-Fi® network.
2. Follow the instructions in the app to complete setup, including creating a SoundTouch® account, adding a music library and music services.

Setting up SoundTouch®

Adding the system to an existing SoundTouch® account

If you have already set up SoundTouch® for another system, you do not need to download the SoundTouch® app again.

1. On your smartphone or tablet, select the SoundTouch® icon  to open the app.
2. Select **EXPLORE > SETTINGS > Systems > ADD SYSTEM** to add another system.

The app guides you through setup.

Connecting the system to a new network

If your network information changes, you must add the system to the new network.

1. On your smartphone, tablet or computer, open the app.
2. From the EXPLORE panel, select **SETTINGS > Systems**.
3. Select your system.
4. Select **CONNECT SYSTEM**.

The app guides you through setup.

Using the SoundTouch® app

The SoundTouch® app is a software application that enables you to set up and control SoundTouch® from your smartphone, tablet or computer. Using the app, your smart device acts as a rich remote for your SoundTouch® system.

The app enables you to manage your SoundTouch® settings, add music services, explore local and global Internet radio stations, set and change Presets, stream music to the system, view what is playing, plus much more.

After you set up the system on your network using the SoundTouch® app, you are ready to explore streaming music and personalize your Presets.

Bluetooth® wireless technology

Bluetooth® wireless technology which lets you stream music from *Bluetooth* devices to your system. You can access the *Bluetooth* feature from the app.

Getting help

 [SoundTouch.com](https://www.soundtouch.com)

Provides access to the owner support center, which includes: owner's manuals, articles, tips, tutorials, a video library, and the owner community where you post questions and answers.

1. Open a browser.
2. In the address field, type **SoundTouch.com**

In-app help

Provides help articles for using SoundTouch®.

1. On your device, select  to open the app.
2. From the EXPLORE panel, select **HELP**.

Controlling the system from another smartphone, tablet or computer

Once you set up the SoundTouch® system on your home Wi-Fi® network, you can control the system from any smartphone, tablet or computer on the same network.

1. Connect the device to the same network as your system.
2. On the device, download and install the SoundTouch® app:
 - If you are using a smartphone or tablet, see page 15.
 - If you are using a computer, open a browser and go to:
SoundTouch.com/app

Using the System

Understanding the Wi-Fi® indicator

The Wi-Fi® indicator shows Wi-Fi status.

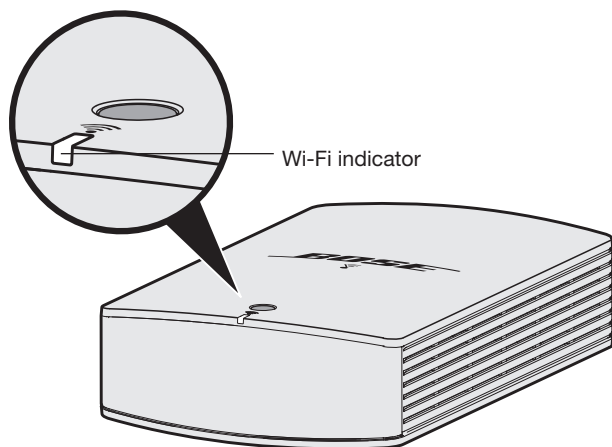

Indicator activity	System state
Blinking white	Searching for Wi-Fi network
Solid white	System on and connected to Wi-Fi network
Solid amber	System in setup mode
Blinking fast amber	Firmware error - call Bose service
Off	Networking disabled or system connected to Ethernet

How Presets work

You can personalize six Presets to your favorite streaming music services, stations, playlists, artists, albums or songs from your music library. You can access your music, at any time, with a simple touch of a button using the SoundTouch® app on your computer, smartphone or tablet.

What you need to know

- You can set Presets from the app.
- If the Preset source is your iTunes or Windows Media Player music library, ensure the computer storing your music library is on and connected to the same network as the SoundTouch® system.
- You cannot set Presets to a *Bluetooth*® stream or connected audio device.

Playing a Preset

Once you personalize your Presets using the app, press a Preset in the app to play it. If you have not set your Presets, open the app and set your Presets. Refer to the in-app help.

Setting a Preset

1. Stream music to the system using the app.
2. While the music is playing, press and hold a Preset in the app.

Note: For information on using the SoundTouch® app to set and change your Presets, refer to the in-app help.

Care and Maintenance

Disabling Wi-Fi® capability

Disabling Wi-Fi® also disables the *Bluetooth*® feature.

1. Press and hold the **Control** button (8-10 seconds).

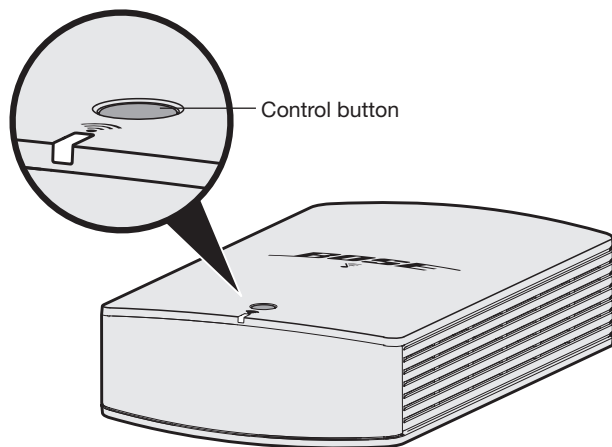

2. When the Wi-Fi indicator turns off, release the **Control** button.

Re-enabling Wi-Fi® capability

Re-enabling Wi-Fi also re-enables the *Bluetooth* feature.

Press the **Control** button until the Wi-Fi indicator turns on (two seconds).

Resetting the system

Factory reset clears all source, volume, and network settings from the system and returns it to original factory settings.

Your SoundTouch® account—and presets—still exist but are not associated with the system unless you use the same account to set up the system again.

1. Unplug the power cable.
2. Press and hold the **Control** button while reconnecting the cable.
3. Release the button when the Wi-Fi indicator blinks.

Troubleshooting

Problem	What to do
Cannot complete network setup	<ul style="list-style-type: none"> • Connect the system to AC (mains) power. • Select correct network name and enter password. • Connect the device and SoundTouch® system to the same Wi-Fi® network. • Place the system within range of the router. • Enable Wi-Fi on the device (mobile or computer) you are using for setup. • Close other open applications. • If using a computer for setup, check firewall settings to ensure that the SoundTouch® app and SoundTouch® Music Server are allowed programs. • Test your Internet connection by loading SoundTouch.com • Restart your mobile device or computer and your router. • Uninstall the app, reset the system and restart setup.
Cannot connect to network	<ul style="list-style-type: none"> • If your network information has changed or to connect your system to another network, refer to the in-app help. • Connect to the network using an Ethernet cable.
Intermittent or no audio	<ul style="list-style-type: none"> • Move system away from possible interference (microwaves, cordless phones, etc.). • Stop other audio or video streaming applications. • Move your mobile device closer to the amplifier and away from any interference or obstructions. • Move amplifier or audio device closer to wireless router or access point. • Ensure volume is not muted or too low. • Unplug the power cord; reconnect after one minute.
Neither speaker plays	<ul style="list-style-type: none"> • Connect the amplifier to AC (mains) power. • Fully insert the power cord into a fully-powered AC (mains) outlet. • Play content using the SoundTouch® app. • Disconnect AC power from the amplifier for three minutes. Reconnect power to the amplifier.
Only one speaker plays	<ul style="list-style-type: none"> • Make sure the speaker wires are in good condition. • Firmly connect the speaker wires at both ends.
One speaker still does not play	<ul style="list-style-type: none"> • Disconnect the wire from the working speaker and attach it to the non-working speaker. If the speaker does not play, the problem may be with the speaker and not the speaker wire. • Disconnect the speaker wire from the terminal block connector. Connect it to the other terminal block connector. If the speaker plays, the problem may be the other speaker wire. Replace the speaker wire. If the speaker does not play, the problem may be in that channel of the amplifier.

Care and Maintenance

Problem	What to do
Right and left stereo channels are heard on the wrong speakers	Confirm speaker wire connections: <ul style="list-style-type: none">• Connect speaker wires from the amplifier's SPEAKERS OUT + L - connector to your left speaker.• Connect speaker wires from the amplifier's SPEAKERS OUT + R - connector to your right speaker.
Bass or treble is weak	Check speaker wire connections. Confirm that the individual wires are connected + to + and - to -.
Interference	<ul style="list-style-type: none">• Firmly insert the speaker wires into the terminals on the back of the speakers and on the amplifier's connector panel. Confirm that no individual wires are touching across terminals.• Keep the system away from metal objects, other audio/video components, and direct heat sources.

Overload protection

The amplifier's overload protection feature automatically reduces maximum power output to prevent the amplifier from getting too hot. This may occur when the amplifier plays at high volume for a long duration or if it is installed in a location with limited ventilation. Ensure the system is installed in a well-ventilated area. Full maximum output automatically returns as the system cools down.

Cleaning

CAUTION: Disconnect the power cord from the AC (mains) power outlet before cleaning.

To clean the amplifier, use only a soft, dry cloth to remove dust from the outside of the enclosure. You may use a brush attachment on a vacuum cleaner to clean the hard-to-reach areas. **DO NOT** use any solvents, chemicals or cleaning solutions containing alcohol, ammonia or abrasives.

Customer service

For additional help using the system:

- Visit SoundTouch.com
- Contact Bose customer service. Refer to the quick start guide in the carton for contact information.

Limited warranty information

Your SoundTouch® system is covered by a limited warranty. Details of the limited warranty are provided on the quick start guide in the carton. Please refer to the guide for instructions on how to obtain warranty service and register your product. Failure to register will not affect your limited warranty rights.

The warranty information provided with this product does not apply in Australia and New Zealand. See our website at www.bose.com.au/warranty or www.bose.co.nz/warranty for details of the Australia and New Zealand warranty.

Technical information

Features

- Bose® proprietary digital signal processing technology
- Built-in digital volume control
- Thermal overload protection

Dimensions and Weight

- 7¼ in. wide x 12 in. deep x 3 in. high (18.4 cm x 30.0 cm x 7.7 cm)
- 3.3 lb (1.5 kg)

Power rating

100-240V \sim 50/60 Hz, 400W

Input sensitivity

- 3.5 mm input: 1Vrms
- RCA inputs: 2Vrms

Signal to Noise ratio (S/N)

>100 dB

Output power (continuous average)

100W / channel minimum into 8 ohms, from 20 Hz to 20 kHz, with no more than 0.6% THD.

Temperature range

32° F to 104° F (0° C to 40° C)

Appendix A: Connector Panel

Connectors

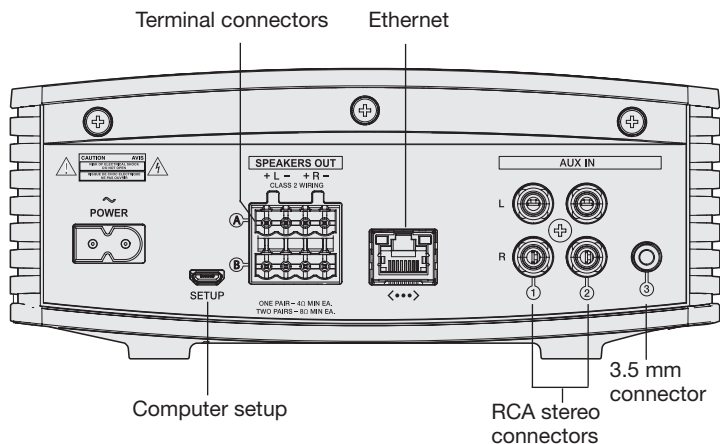

Connector	Description
POWER	AC power cord connector. Power is applied when the power cord is inserted and plugged into an AC (mains) outlet. There is no on/off switch on the SoundTouch® amplifier.
SETUP	USB connector for setup using a computer.
Ethernet	Ethernet connector enables wired access to your home network.
SPEAKERS OUT	Two terminal block connectors enable you to connect two pairs of speakers. <ul style="list-style-type: none">• Left and right speaker outputs.• Connect only unpowered speakers.• One pair of speakers requires 4 ohm minimum each.• Two pairs of speakers require 8 ohm minimum each.• To determine the correct speaker wire size, see page 10.
AUX IN	<ul style="list-style-type: none">• Three AUX IN connectors enable playback from audio devices and media players.

Appendix B: Wall Mounting Instructions

Mounting hardware specifications

You can mount the amplifier on a wall with the provided mounting bracket and hardware.

WARNING: Do not mount on surfaces that are not sturdy enough, or that have hazards concealed behind them, such as electrical wiring or plumbing. If you are not sure about installing the bracket, contact a qualified professional installer. Ensure the bracket is installed according to local building codes.

Item	Wood	Wallboard
Wall thickness	¾ in. (19 mm) or thicker	⅝ in. (9.5 mm) or thicker
Drill bit	⅝ in. (2.38 mm)	¼ in. (6.35 mm)
Phillips-head wood screws (2)	#10 x 1 ¼ in. (M5 x 32 mm)	
Plastic anchors (2)	Not used	#10 (M5) plastic anchors

Appendix B: Wall Mounting Instructions

Mounting the bracket to the wall

Use the provided mounting hardware to secure the provided mounting bracket to the wall.

WARNINGS:

- Only wall mount the amplifier with the bracket provided with your system.
- Do not mount the bracket on the ceiling.

CAUTION: Do not place or install the bracket or system near any heat sources, such as fireplaces, radiators, heat registers or other apparatus (including amplifiers) that produce heat. Additionally when mounting near a TV consult your TV's owner's guide for related mounting information.

1. Position the mounting bracket on the wall with arrows visible and pointing up.

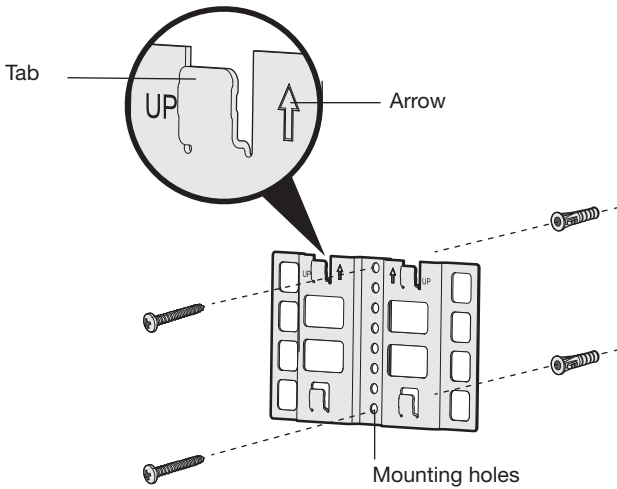

2. Mark the top and bottom mounting hole locations on the wall through the bracket's mounting holes.
3. Remove the bracket.
4. Drill two holes in the wall.
5. Align the bracket to the drilled holes.

Note: If mounting the bracket to wallboard, you must insert the anchors into the wall before you attach the bracket to the wall.

6. Insert and tighten screws (and anchors, if used).

Appendix B: Wall Mounting Instructions

Attaching the amplifier to the mounting bracket

You can attach the amplifier to the bracket vertically or horizontally.

- Do not mount the amplifier on the ceiling.
- Do not mount the amplifier with the connector panel at the bottom.

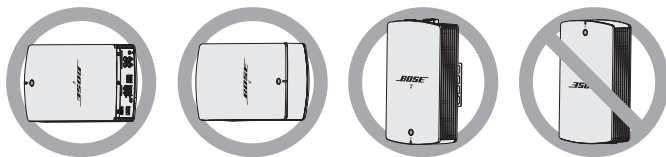

1. Align the four latches on the back of the amplifier with the bracket's four tabs.

Tip: For vertical mounting, the connector panel must be on top.

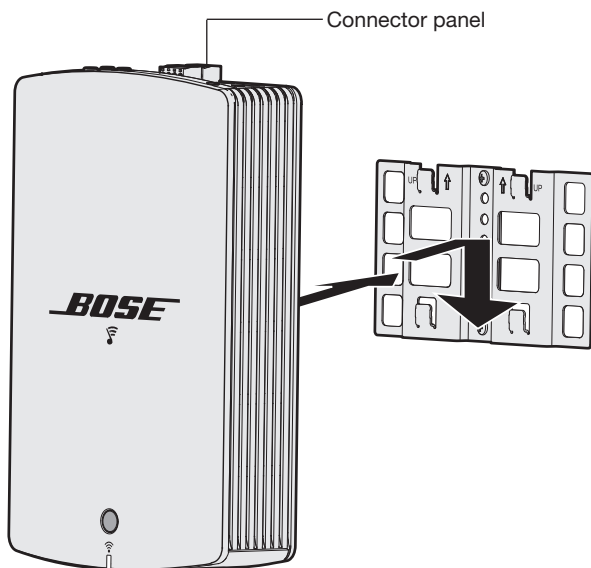

2. Gently push the amplifier down onto the bracket's tabs until the amplifier clicks into place.

Appendix C: Using a Computer for Setup

Important setup information

- You can set up your system using a computer rather than a smartphone or tablet.
 - Use a computer that is on your Wi-Fi® network.
 - Use a computer where your music library is stored.
 - You need the provided USB cable.*
 - Do not connect the USB cable until the app instructs you to connect the cable.
- *The USB connector on the back of the system is for computer setup only. The USB connector is not designed to charge smartphones, tablets or similar devices.

Using a desktop computer for setup

If you are using a desktop computer, move the system near the computer to set up your system. During setup, the app prompts you to connect the USB cable from the computer to the system (temporarily).

After setup, disconnect the USB cable from your computer and from your system and move the system to its permanent location.

Setting up the system using a computer

1. Plug the power cord into an AC (mains) power outlet.
2. On your computer, open a browser and go to
SoundTouch.com/app
Tip: Use the computer where your music library is stored.
3. Download and run the SoundTouch® app.
The app guides you through setup.





759224-0010

BOSE[®]
Better sound through research[®]

©2015 Bose Corporation, The Mountain,
Framingham, MA 01701-9168 USA
AM759224 Rev. 00