

BOSE[®]

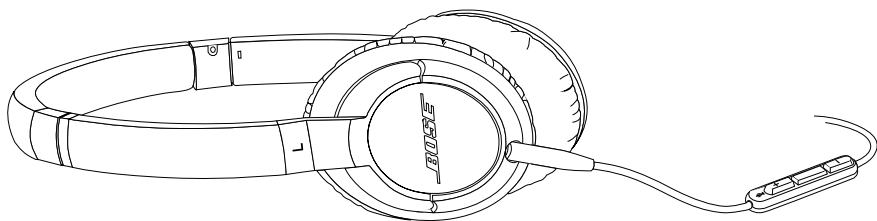

Bose[®] SoundTrue[™]
ON-EAR HEADPHONES

Owner's Guide | Guía del usuario | Notice d'utilisation

Safety

Please read this owner's guide carefully and save it for future reference.

WARNINGS:

- Long-term exposure to loud music may cause hearing damage. It is best to avoid extreme volume when using headphones, especially for extended periods.
- Sounds that you rely on as reminders or warnings may have an unfamiliar character when using headphones. Be aware of how these sounds may vary in character so you can recognize them as needed.
- Do not place any naked flame sources, such as lighted candles, on or near the apparatus.
- This product contains magnetic material. Please contact your physician if you have any questions on whether this might affect the operation of your implantable medical device. 
- DO NOT use mobile phone adapters to connect headphones to airplane seat jacks as this could result in personal injury such as burns or property damage due to overheating. Remove and disconnect immediately if you experience warming sensation or loss of audio.
- Do not submerge or expose for extended period to water or wear while participating in water sports, i.e. swimming, waterskiing, surfing, etc.

CAUTIONS:

- Do not drop, sit on or allow the headphones to be immersed in water.
- Be sure the earcup ports are kept clear, and that no moisture is allowed to get inside the earcup.

 This product conforms to all applicable EU directive requirements. The complete declaration of conformity can be found at www.Bose.com/compliance

Limited Warranty

Your Bose® headphones are covered by a limited warranty. Details of the limited warranty are provided on the product registration card that is included in the carton. Please refer to the card for instructions on how to register. Failure to register will not affect your limited warranty rights.

Names and Contents of Toxic or Hazardous Substances or Elements						
Part Name	Toxic or Hazardous Substances and Elements					
	Lead (Pb)	Mercury (Hg)	Cadmium (Cd)	Hexavalent (CR(VI))	Polybrominated Biphenyl (PBB)	Polybrominated diphenylether (PBDE)
PCBs	X	0	0	0	0	0
Metal parts	X	0	0	0	0	0
Plastic parts	0	0	0	0	0	0
Speakers	X	0	0	0	0	0
Cables	X	0	0	0	0	0

O: Indicates that this toxic or hazardous substance contained in all of the homogeneous materials for this part is below the limit requirement in SJ/T 11363-2006.

X: Indicates that this toxic or hazardous substance contained in at least one of the homogeneous materials used for this part is above the limit requirement in SJ/T 11363-2006.



iPad, iPhone, iPod, iPod classic, iPod nano, iPod shuffle and iPod touch are trademarks of Apple Inc., registered in the U.S. and other countries.

“Made for iPod,” “Made for iPhone,” and “Made for iPad” mean that an electronic accessory has been designed to connect specifically to iPod, iPhone, or iPad, respectively, and has been certified by the developer to meet Apple performance standards. Apple is not responsible for the operation of this device or its compliance with safety and regulatory standards. Please note that the use of this accessory with iPod, iPhone, or iPad may affect wireless performance.

Contents

Welcome.....	5
Components.....	5
Wearing the headphones.....	6
Connecting to your iPhone, iPod, or iPad.....	6
Using the headphones with your iPhone, iPod, or iPad.....	6
For use with.....	6
Headphone controls.....	6
Basic functions.....	7
Media playback functions.....	7
Folding earcups.....	8
Storing the headphones.....	8
Replacing earcup cushions.....	9
Troubleshooting.....	10
Cleaning the headphones.....	10
Replacement parts and accessories.....	10

Welcome

Thank you for purchasing the Bose® SoundTrue™ on-ear headphones. Enjoy your music with smooth, full range sound, a comfortable on-ear fit and a contoured design that folds up for easy portability. An inline remote and microphone provide convenient control of select iPhone, iPod and iPad models.

Components

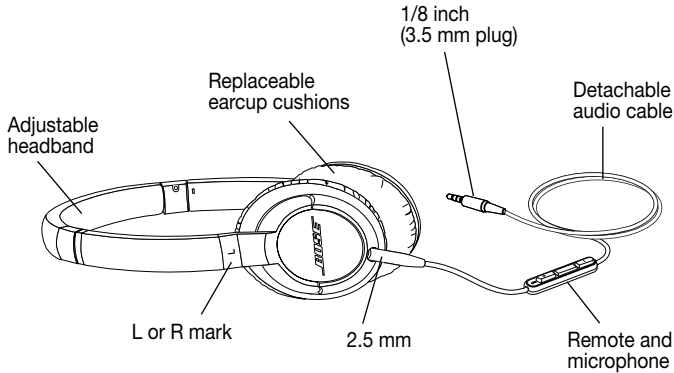

Using the headphones

Wearing the headphones

Put on the headphones using the markings which identify the left (L) and right (R) earcups. Adjust the headband so it rests gently on top of your head and the earcup cushions fit comfortably around your ears.

Connecting to your iPhone, iPod, or iPad

Connect the smaller (2.5 mm) plug securely to the left earcup. Connect the other plug securely to the audio output jack of the iPhone, iPod or iPad. You should hear or feel a click when you make these connections.

Using the headphones with your iPhone, iPod, or iPad

The headphones have a small in-line remote with an integrated microphone for convenient control of select iPhone, iPod, and iPad models.

For use with

The remote and mic are supported only by iPhone 3GS or later, iPad, iPod touch (2nd generation or later), iPod classic (120GB, 160GB), and iPod nano (4th generation or later). The remote is supported by iPod shuffle (3rd generation or later). Audio is supported by all iPad and iPod models.

Note: Full controls may not be available for some iPhone, iPod, or iPad models.

Note: For information on using your headphones with non Apple devices, refer to <http://global.Bose.com>

Headphone controls

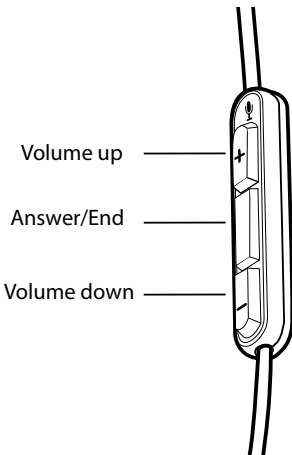

Using the headphones

Basic functions

Increase volume	Press and release the + button.
Decrease volume	Press and release the – button.
Answer a call	When you receive an incoming call, press and release the Answer/End button to answer.
End a call	Press and release the Answer/End button.
Decline an incoming call	Press and hold the Answer/End button for about two seconds, then release.
Switch to an incoming or on-hold call and put the current call on hold	While on a call, press and release the Answer/End button once. Press and release again to switch back to the first call.
Switch to an incoming or on-hold call and end the current call	While on a call, press and hold the Answer/End button for about two seconds, then release.
Use Voice Control	Press and hold the Answer/End button. <i>See iPhone User Guide for compatibility and usage information about this feature.</i>

Media playback functions

Play or pause a song or video	Press and release the Answer/End button.
Skip to the next song or chapter	Press and release the Answer/End button twice quickly.
Fast forward	Press and release the Answer/End button twice quickly and hold the second press.
Go to the previous song or chapter	Press and release the Answer/End button three times quickly.
Rewind	Press and release the Answer/End button three times quickly and hold the third press.

Using the headphones

Folding earcups

The Bose® SoundTrue™ on-ear headphones feature rotating earcups that fold flat for easy, convenient storage. The earcups rotate in only one direction. Incorrectly rotating the earcups can damage the headphones.

Storing the headphones

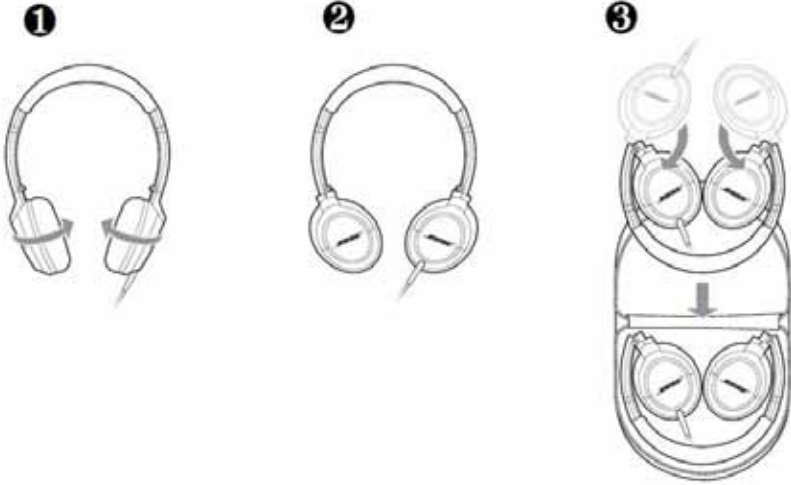

Note: Do not try to exceed the limits of the pivots or over-rotate the ear-cups.

Replacing earcup cushions

Remove earcup cushion:

1. Grasp the earcup cushion securely.
2. Pull up and out to remove the earcup cushion.

Re-attach earcup cushion:

1. Place the edge of the earcup cushion skirt into the slot behind the earcup flange.
2. Work the remainder of the skirt into the slot all the way around the earcup.

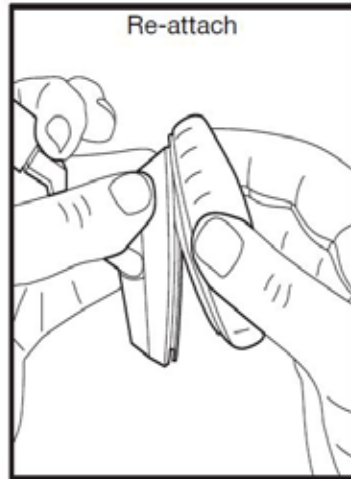
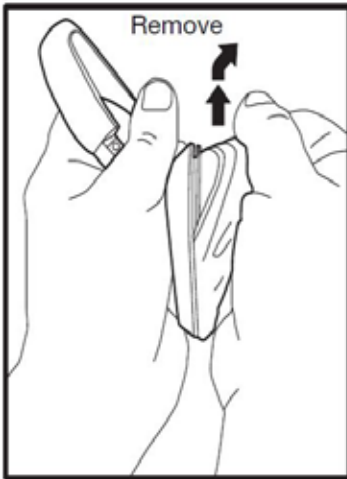

Using the headphones

Troubleshooting

If you experience any trouble using your headphones, try the following troubleshooting instructions. If you still need help, contact Bose Customer Service.

Problem	What to do
No audio or audio in one earcup only	<ul style="list-style-type: none">• Make sure both ends of the audio cable are firmly connected.• Try another audio device.
Distorted bass	<ul style="list-style-type: none">• Make sure both ear cushions are firmly secured.
Mis-shaped cushion	<ul style="list-style-type: none">• The high-density earcup foam will regain its shape after a few minutes in a neutral position.
Microphone is not picking up sound	<ul style="list-style-type: none">• Make sure that the headphone plug is securely connected to the headphone jack.• Make sure the microphone is not being blocked or covered. <p><i>The microphone is located on the back of the Answer/End button. (You may notice the small opening for the microphone.)</i></p>
Phone not responding to button presses	<ul style="list-style-type: none">• Make sure that the headphone plug is securely connected to the headphone jack.• For multi-press functions: Vary speed of presses.
iPhone, iPod, or iPad not responding to remote	<ul style="list-style-type: none">• Full controls may not be available for some iPhone, iPod, and iPad models .

Cleaning the headphones

The headphones do not require scheduled cleaning. Should cleaning be necessary, simply wipe the outside surfaces with a soft cloth. Be sure the earcup ports are kept clear, and that no moisture is allowed to get inside the earcup.

Replacement parts and accessories

Accessories or replacement parts can be ordered through Bose Customer Service at <http://global.Bose.com>

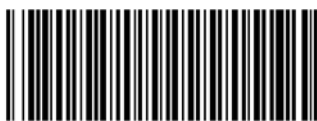

714524-0010

BOSE[®]
Better sound through research[®]

©2014 Bose Corporation, The Mountain,
Framingham, MA 01701-9168 USA
AM714524 Rev. 00