

Owner's Guide

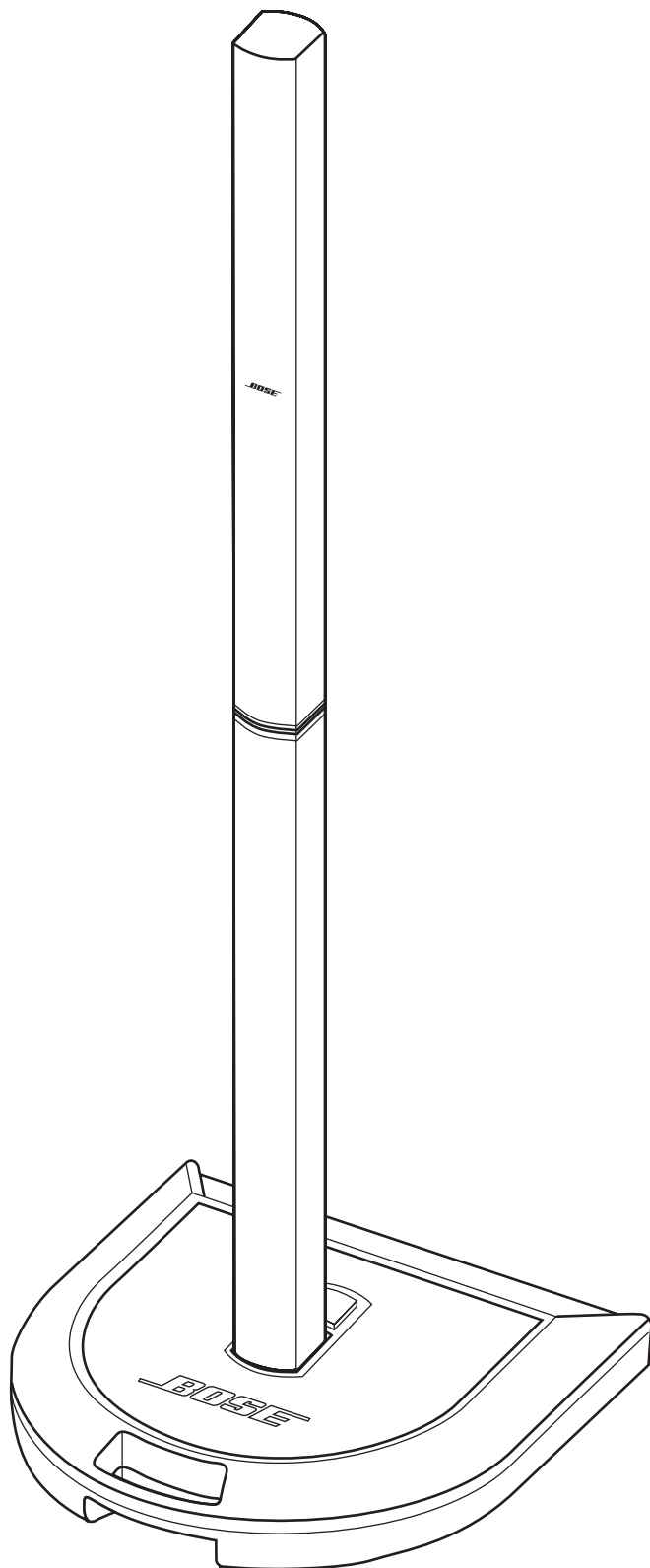



BOSE®

TM
"A Mark of Quality"

Safety Information

Please read this owner's guide

Please take the time to follow the instructions in this owner's guide carefully. It will help you set up and operate your system properly and enjoy all of its advanced features. Please save this owner's guide for future reference.

-  **WARNING:** To reduce the risk of fire or electrical shock, do not expose the system to rain or moisture.
-  **WARNING:** To prevent electric shock, match the wide blade of the line cord plug to the wide slot of the AC (mains) receptacle.

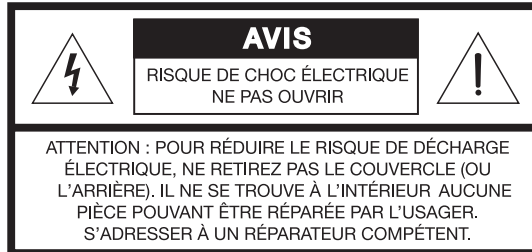
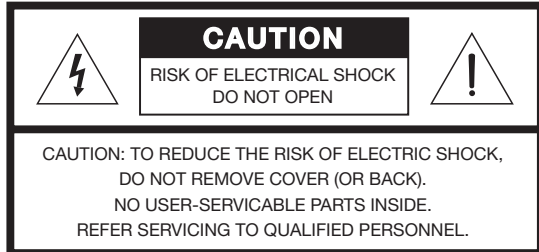

-  **WARNING:** To reduce the risk of electric shock, do not disassemble this system unless you are qualified. Refer servicing to qualified service personnel.



These CAUTION marks may be located on the enclosures of the *Personalized Amplification System™ PS1* power stand:



The lightning flash with arrowhead symbol within an equilateral triangle alerts the user to the presence of uninsulated dangerous voltage within the system enclosure that may be of sufficient magnitude to constitute a risk of electrical shock.



The exclamation point within an equilateral triangle, as marked on the system, is intended to alert the user to the presence of important operating and maintenance instructions in this owner's guide.

-  **CAUTION:** No naked flame sources, such as lighted candles, should be placed on the apparatus.
-  **CAUTION:** Where the mains plug is used as the disconnect device, such disconnect device shall remain readily operable.

1. Read these instructions.
2. Keep these instructions.
3. Heed all warnings.
4. Follow all instructions.
5. Do not use this apparatus near water.
6. Clean only with a dry cloth.
7. Do not block any ventilation openings. Install in accordance with the manufacturer's instructions.
8. Do not install near any heat sources, such as radiators, heat registers, stoves or other apparatus (including amplifiers) that produce heat.
9. Do not defeat the safety purpose of the polarized or grounding-type plug. A polarized plug has two blades with one wider than the other. A grounding-type plug has two blades and a third grounding prong. The wider blade or third prong is provided for your safety. If the provided plug does not fit into your outlet, consult an electrician for replacement of the obsolete outlet.
10. Protect the power cord from being walked on or pinched, particularly at plugs, convenience receptacles, and the point where they exit from the apparatus.
11. Only use attachments/accessories specified by the manufacturer.
12. Use only with the cart, stand, tripod, bracket or table specified by the manufacturer or sold with the apparatus. When a cart is used, use caution when moving the cart/apparatus combination to avoid injury from tip-over.
13. Unplug this apparatus during lightning storms or when unused for long periods of time.



Information about products that generate electrical noise

This equipment has been tested and found to comply with the limits for a Class A digital device, pursuant to Part 15 of the FCC rules. These limits are designed to provide reasonable protection against harmful interference in a commercial environment. This equipment generates, uses, and can radiate radio frequency energy and, if not installed and used in accordance with the instructions, may cause harmful interference to radio communications. Operation of this equipment in a residential area is likely to cause harmful interference in which case the user will be required to correct the interference at his own expense.

This product complies with the Canadian ICES-003 Class A specifications.

14. Refer all servicing to qualified service personnel. Servicing is required when the apparatus has been damaged in any way, such as power-supply cord or plug is damaged, liquid has been spilled or objects have fallen into the apparatus, the apparatus has been exposed to rain or moisture, does not operate normally, or has been dropped.
15. To prevent risk of fire or electric shock, avoid overloading wall outlets, extension cords, or integral convenience receptacles.
16. Do not let objects or liquids enter the product – as they may touch dangerous voltage points or short-circuit parts that could result in a fire or electric shock.
17. See product enclosure bottom for safety related markings.
18. Use proper power sources – Plug the product into a proper power source, as described in the operating instructions or as marked on the product.
19. Apparatus shall not be exposed to dripping or splashing, and no objects filled with liquids, such as vases, shall be placed on the apparatus.

Lea esta guía del usuario

Dedique el tiempo que sea necesario para seguir las instrucciones de esta guía del usuario cuidadosamente. Le ayudará a configurar y utilizar correctamente el sistema y a disfrutar de todas sus funciones avanzadas. Guarde la guía del usuario para utilizarla como material de referencia en el futuro.

ADVERTENCIA: Con el fin de reducir el riesgo de descargas eléctricas, no exponga el sistema a la lluvia o la humedad.

ADVERTENCIA: Para evitar que se produzcan descargas eléctricas, ponga la patilla de hoja plana de la clavija del cable de línea en la ranura ancha de la toma de CA (red eléctrica).

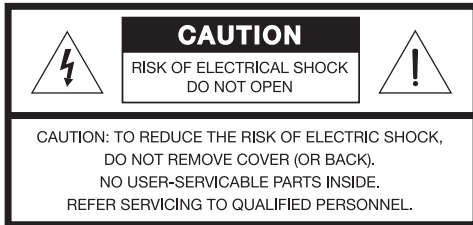

ADVERTENCIA: Para reducir el riesgo de descargas eléctricas, no desmonte el sistema si no es usted un técnico cualificado. Las reparaciones debe llevarlas a cabo personal cualificado. Las indicaciones de PRECAUCIÓN que se muestran en este manual se encuentran en las cajas del sistema.

Estas marcas de PRECAUCIÓN se pueden encontrar en las cajas del pedestal PS1 *Personalized Amplification System*™:



El símbolo de un relámpago con una flecha dentro de un triángulo equilátero avisa al usuario de que dentro de la caja del sistema puede haber voltaje sin aislar de una magnitud suficiente para constituir un riesgo de descarga eléctrica.



El signo de exclamación dentro de un triángulo equilátero, tal como aparece marcado en el sistema, sirve para avisar al usuario de que existen instrucciones de funcionamiento y mantenimiento importantes en esta guía del usuario.

PRECAUCIÓN: No coloque sobre el aparato ninguna fuente de llama viva, como velas encendidas.

PRECAUCIÓN: Cuando se usa la clavija de conexión a la red eléctrica como dispositivo de desconexión, debe ser posible usar este dispositivo de forma inmediata.

Instrucciones de seguridad importantes

1. Lea las siguientes instrucciones.
2. Lea las siguientes instrucciones.
3. Tenga presentes todas las advertencias.
4. Siga todas las instrucciones.
5. No utilice este aparato cerca del agua o humedad.
6. Límpielo sólo con un trapo seco.
7. No bloquee las aberturas de ventilación. Realice la instalación de acuerdo con las instrucciones del fabricante.
8. No lo instale cerca de fuentes de calor, tales como radiadores, salidas de aire caliente, hornos u otros aparatos (incluidos amplificadores) que generen calor.
9. No elimine el dispositivo de seguridad del enchufe con toma a tierra o polarizado. Los enchufes polarizados disponen de dos clavijas, una de mayor tamaño que la otra. Los enchufes con toma de tierra tienen dos patillas y un tercer terminal de tierra. La patilla más ancha y el tercer terminal se incluyen como medida de seguridad. Si el enchufe suministrado no encaja en la toma, póngase en contacto con un electricista para sustituir la toma antigua.
10. Proteja el cable de alimentación de forma que nadie lo pise ni quede apretado, en particular cerca de los enchufes, receptáculos de tomas múltiples y en el lugar en que sale del aparato.
11. Utilice sólo conexiones y accesorios suministrados por el fabricante.
12. Utilícelo sólo con el carrito, soporte, trípode, abrazadera o mesa suministrado por el fabricante o incluido con el dispositivo. Cuando se utilice un carrito, tenga cuidado al mover la combinación de carrito/dispositivo para evitar que se produzcan lesiones en caso de que se caiga.
13. Desenchufe el aparato eléctrico en caso de tormenta eléctrica o cuando no vaya a utilizarlo durante mucho tiempo.
14. Toda reparación debe ser realizada por personal cualificado. Lleve el dispositivo a reparar si presenta algún daño como, por ejemplo, si el cable de alimentación o el enchufe están dañados, si se han vertido líquidos o se han caído objetos sobre el dispositivo o si éste ha estado expuesto a la lluvia o humedad; si no funciona correctamente o se ha caído al suelo.
15. Para prevenir el riesgo de incendio o descarga eléctrica, evite la sobrecarga de los enchufes, alargadores o receptáculos de las tomas.
16. Impida que caigan objetos o líquidos sobre el producto, ya que podrían entrar en contacto con puntos de niveles de voltaje altos o partes que podrían sufrir un cortocircuito y causar incendios o descargas eléctricas.
17. Consulte las indicaciones de seguridad en la parte inferior de la caja del producto.
18. Utilice fuentes de alimentación adecuadas: conecte el producto a una fuente de alimentación, tal y como se describe en las instrucciones de funcionamiento o como está marcado en el propio producto.
19. El aparato no debe recibir salpicaduras ni mojarse, por lo que cualquier objeto que contenga líquido, como jarrones, no debe colocarse sobre éste.



Veillez lire cette notice d'utilisation

Prenez le temps de lire attentivement les instructions de cette notice d'utilisation. Elles vous seront précieuses pour installer et utiliser correctement votre système et vous aideront à tirer le meilleur parti de sa technologie. Conservez cette notice d'utilisation pour référence ultérieure.

AVERTISSEMENT : Afin de limiter les risques d'incendie ou d'électrocution, n'exposez pas l'appareil à la pluie ou à l'humidité.

AVERTISSEMENT : Afin d'éviter tout risque d'électrocution, insérez bien la fiche du cordon d'alimentation dans la fente correspondante de la prise d'alimentation.

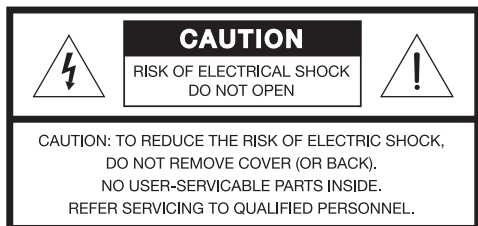

AVERTISSEMENT : Afin de limiter les risques d'électrocution, ne démontez pas ce système à moins de disposer des qualifications requises. Adressez-vous à un réparateur qualifié. Les marquages de SÉCURITÉ présentés sur cette page sont situés sur les boîtiers de votre système.

Ces marquages de SÉCURITÉ peuvent être situés sur les boîtiers du socle amplificateur PS1 Personalized Amplification System™ :



Le symbole représentant un éclair avec une flèche à l'intérieur d'un triangle équilatéral est utilisé pour prévenir l'utilisateur de la présence d'une tension électrique dangereuse non isolée à l'intérieur de l'appareil. Cette tension est d'un niveau suffisamment élevé pour représenter un risque d'électrocution.



Le symbole représentant un point d'exclamation à l'intérieur d'un triangle équilatéral, tel qu'il figure sur le système, signale à l'utilisateur la présence d'instructions importantes relatives au fonctionnement et à l'entretien de l'appareil dans cette notice d'installation.

ATTENTION : Ne placez jamais d'objets enflammés, tels que des bougies allumées, sur l'appareil.

ATTENTION : Lorsque la fiche d'alimentation est utilisée comme dispositif de débranchement de l'appareil, elle doit rester facilement accessible.

Instructions importantes relatives à la sécurité

1. Veillez lire ces instructions.
2. Veillez conserver ces instructions.
3. Respectez tous les avertissements.
4. Suivez toutes les instructions.
5. N'utilisez pas cet appareil à proximité d'eau ou d'une source d'humidité.
6. Utilisez uniquement un chiffon sec pour le nettoyage.
7. Ne bloquez jamais les orifices d'aération. Suivez les instructions du fabricant pour l'installation.
8. N'installez pas cet appareil à proximité d'une quelconque source de chaleur, telle qu'un radiateur, une arrivée d'air chaud, un four ou tout autre appareil (notamment les amplificateurs) produisant de la chaleur.
9. Ne tentez pas de modifier les dispositifs de sécurité que constituent les fiches de type terre ou polarisées. Les fiches polarisées sont équipées de deux bornes de largeurs différentes. Les fiches de type terre sont équipées de deux bornes et d'un orifice permettant la mise à la terre. Ces deux types de dispositifs ont pour but d'assurer votre sécurité. Si la prise fournie ne s'adapte pas à votre prise de courant, consultez un électricien pour qu'il remplace cette prise obsolète.
10. Protégez le cordon d'alimentation contre les risques de piétinement ou de pincement, notamment au niveau des fiches, des prises de courant et des branchements à l'appareil.
11. Utilisez uniquement les accessoires spécifiés par le fabricant.
12. Utilisez uniquement le chariot, le support, le trépied, l'équerre ou la table spécifié(e) par le fabricant ou vendu(e) avec l'appareil. Lorsque vous utilisez un chariot, faites attention à ne pas vous blesser en déplaçant l'ensemble chariot/appareil, car celui-ci risque de basculer. 
13. Débranchez cet appareil pendant les orages ou au cours des longues périodes de non-utilisation.
14. Confiez toute réparation à du personnel qualifié. Une réparation est nécessaire lorsque l'appareil a été endommagé de quelque façon que ce soit (endommagement du cordon d'alimentation ou de la fiche électrique, renversement d'un liquide ou de tout objet sur l'appareil, exposition de l'appareil à la pluie ou à l'humidité, mauvais fonctionnement, chute de l'appareil, etc.).
15. Pour éviter tout risque d'incendie ou d'électrocution, ne surchargez pas les prises murales, les rallonges ou les prises multiples.
16. Ne laissez jamais d'eau ou d'objets pénétrer à l'intérieur du produit : des éléments sous tension pourraient être touchés ou il pourrait se produire un court-circuit susceptible d'entraîner un incendie ou un risque d'électrocution.
17. Examinez les marquages de sécurité présents sur le boîtier du produit.
18. Utilisez des sources d'alimentation appropriées : branchez le produit sur une source d'alimentation appropriée, comme indiqué dans les instructions relatives au fonctionnement ou signalé sur le produit.
19. Protégez l'appareil de tout risque de ruissellement ou d'éclaboussure. Ne placez pas d'objets contenant des liquides, tels que des vases, sur l'appareil.

Where to find...

Setup	7
Before you begin	7
Unpacking	8
Placing the product in the right location for your performance	9
Product assembly	10
Disassembly	11
Connecting a B1 bass module to the PS1 power stand (optional)	12
Connecting one B1 bass module	12
Connecting two B1 bass modules	13
Controls, Indicators and Connections	14
Channel 1/2 connections and controls	14
Channel 3/4 connections and controls	15
Power amp patch, bass, remote and AC power connections	16
R1 remote control features	17
Operating Instructions	18
Producing individualized sound	18
Using input channels 3 and 4	18
Using an effects processor	19
Serial connection method	19
Parallel connection method	19
Using a serial effects connection with the PS1 power stand	20
Using parallel effects connection with the PS1 power stand	21
Troubleshooting	22
Customer service	24
Cleaning your product	24
Limited Warranty and Registration	24
Accessories	24
Technical Information	25
Mechanical	25
Electrical	25
Audio Input/Output	25

For your records

The product serial number is located on the bottom of each component:

PS1 power stand serial number: _____

L1 Cylindrical Radiator™ loudspeaker serial number: _____

B1 bass module (optional) serial number: _____

B1 bass module (optional) serial number: _____

Dealer name: _____

Dealer phone: _____ Purchase date: _____

Please keep your sales receipt together with this owner's guide.

Before you begin

Thank you for purchasing one of the Bose® *Personalized Amplification System*™ family of products. This new revolutionary technology brings the benefits of the intimate acoustic concert to amplified performances.

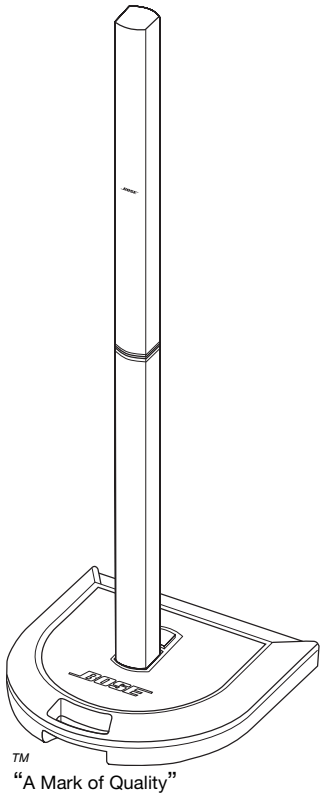

Benefits for musicians

- **You control the sound** – Just as in an unamplified performance, you, and no one else, control the sound. You will no longer wonder how you sound to your fellow musicians or to your audience.
- **Quick and easy setup** – The *Personalized Amplification System*™ product is easy to carry and can be set up in minutes, not hours. This frees you from the time-consuming, draining, and frustrating effort required to properly set up conventional sound equipment.
- **Dramatically improved performance** – Performance and enjoyment dramatically improve because you will no longer struggle to hear yourself and the other musicians.

Benefits for the audience

- **Creates excitement and emotion** – The enhanced performance of the musicians creates the kind of excitement and emotion that is valued by music lovers more than anything else.
- **You hear what the audience hears** – For the first time, musicians hear what their audiences hear and thus, are unlikely to play at uncomfortable sound levels.
- **The music is naturally dynamic** – The softest to the more intense passages can be heard and enjoyed.
- **You look better** – There is less clutter on the stage and more room.
- **Sound reproduction unlike before** – Audience members report that the clarity and excitement that come from hearing the accurate reproduction of sound from each instrument, and from hearing the sound of each instrument in its position on stage (as opposed to mono or even stereo mix of all instruments) is unlike anything they have heard before in an amplified performance.

For more information

This owner's guide provides only basic setup and operating instructions. For more in-depth information on using this system, including tips, techniques, and frequently asked questions, please visit www.bose.com/musicians on the Internet.

Unpacking

Your *Personalized Amplification System*™ products are delivered to you in two cartons. One carton contains the PS1 power stand, AC power cord, R1 remote control with cable, protective plug, Owner's and Quick Setup guides, PS1 carrying bag, CD-ROM, and a spare fuse. The other carton contains the L1 Cylindrical Radiator™ loudspeaker and carrying bags (Figure 1).

If you purchased B1 bass modules, they will be packaged separately with a carrying bag and a (blue) B1 bass module 4-wire cable.

WARNING: To avoid danger of suffocation, keep the plastic bags out of the reach of children.

Note: Now is a good time to record the serial number on the bottom of these components, on page 6 of this guide. Refer to page 24 for registration information.

Figure 1

System components

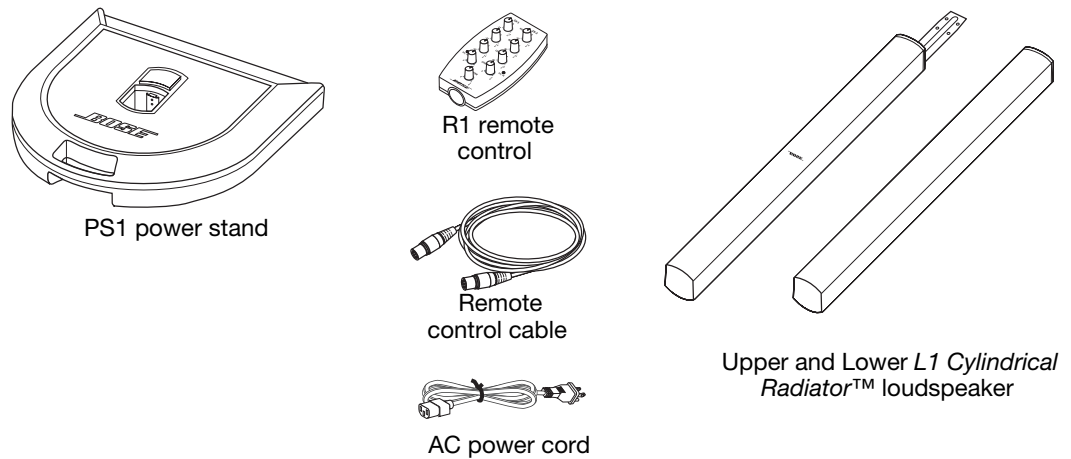
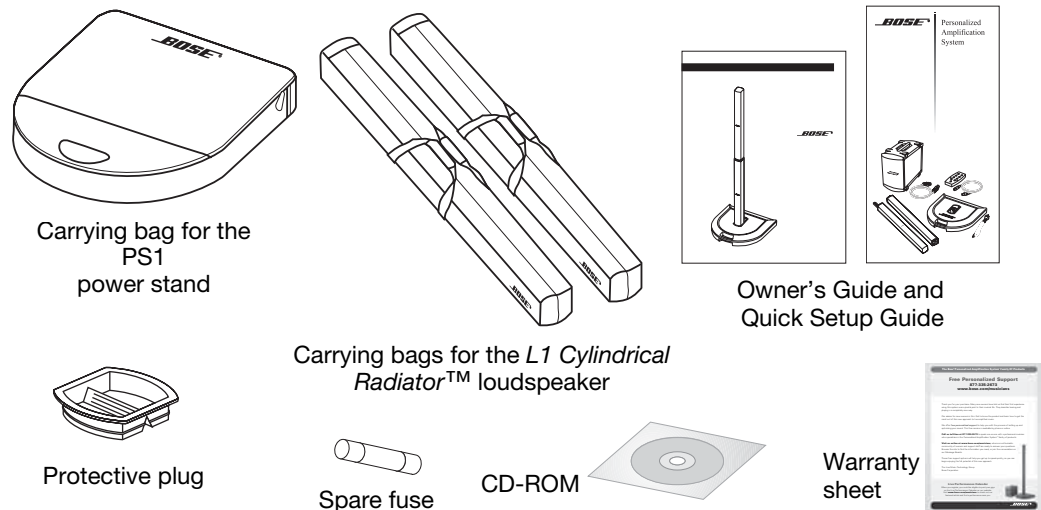

Figure 2

Included equipment



Note: For a complete list of optional equipment and accessories please visit www.bose.com/musicians.

Figure 3

Optional equipment



Placing the product in the right location for your performance

Before you start to assemble this product, it is a good idea to find the best location for it.

WARNING: The completed unit weighs about 60 lb. Moving the completely assembled unit is not recommended.

Placing the PS1 power stand in the right location is an important step in the process of setting up this product to create your own individualized sound. Determining the best location for your performance depends on several things: size of staging area, number of performers, and if you will be sharing the PS1 power stand connections.

The following guidelines should get you started in setting up for a concert or show.

Note: For more information on setting up your Personalized Amplification System™ product to achieve an individualized sound, visit www.bose.com/musicians on the Internet.

- Place the product at the rearmost part of the performance area or stage.
- If possible, position the product behind the performer.
- If you are part of a group, avoid crowding together on stage. Allow some distance (ideally 7-8 feet) between you and the *L1 Cylindrical Radiator™* loudspeaker and another performer. This allows the sound to wrap around performers and reflect off adjacent surfaces of the room, creating a more pleasing room-filling sound.

Figure 4

Placement recommendations

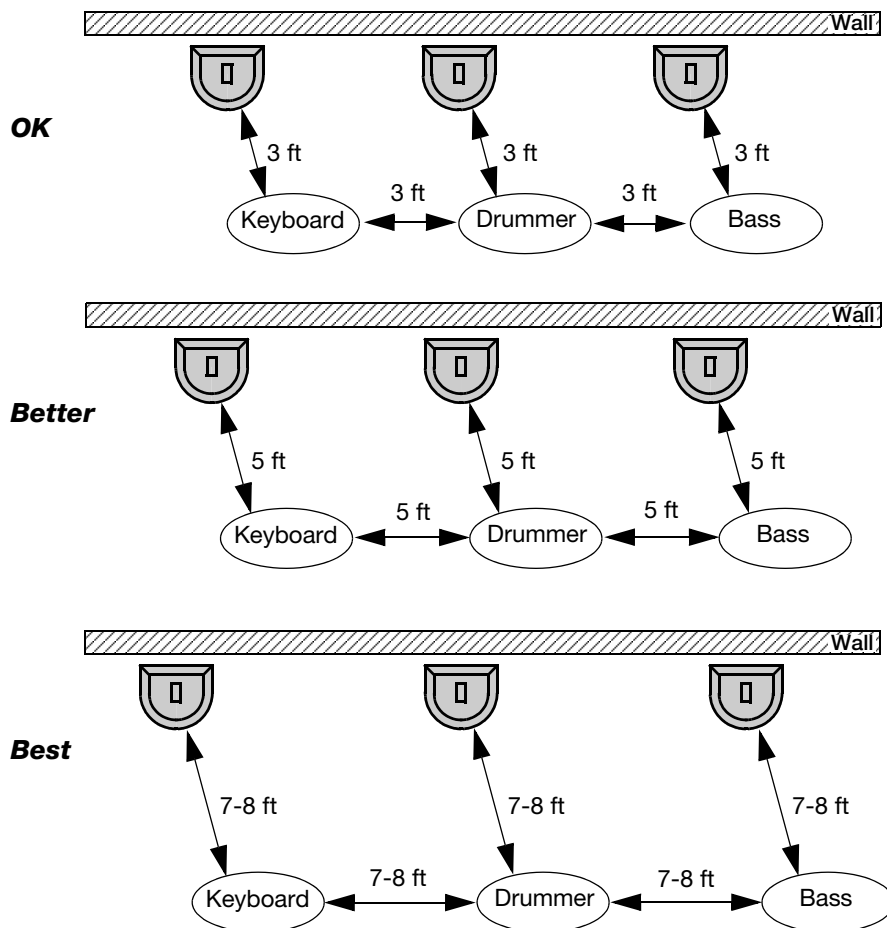

Product assembly

1. Place the PS1 power stand on the floor. Place it on a flat, dry, stable surface at the rearmost part of the stage, handle facing forward, behind the performer.

⚠ WARNING: The completed unit weighs about 60 lb. Moving the completely assembled unit is not recommended.

For placement guidelines, see “Placing the product in the right location for your performance” on page 9.

2. Insert the bottom section of the L1 Cylindrical Radiator™ loudspeaker into the PS1 power stand. You should hear a soft click when it is properly seated and locked in place.

🎵 Note: Electrical connections between the PS1 power stand and L1 Cylindrical Radiator™ loudspeaker are made automatically as you assemble the product.

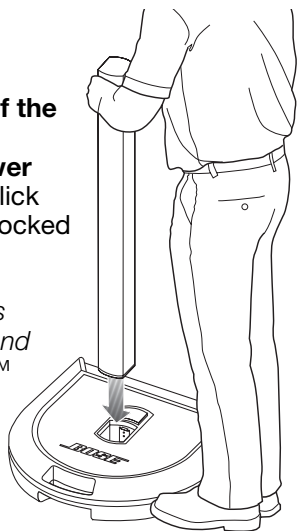
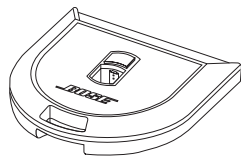

3. Mount the top section of the L1 Cylindrical Radiator™ loudspeaker. Place one foot on the PS1 power stand to support your back. Insert the bayonet on the top section into the channel that runs along the back of the bottom section. Lower the top section until it is flush with the top of the bottom section. You should hear a soft click as the top section locks in place.

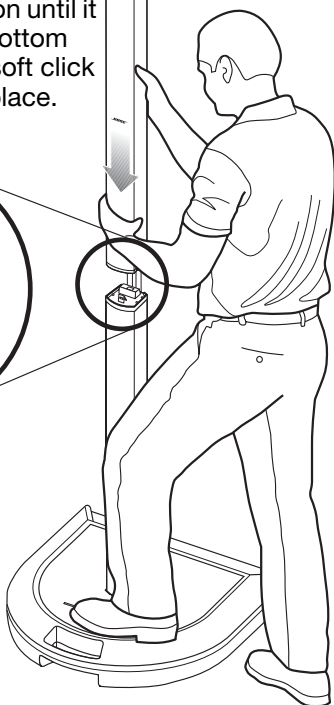
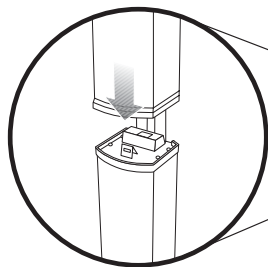

4. Connect the R1 remote control to the PS1 power stand. Plug the R1 remote control cable into either end of the remote. Plug the other end into the Remote jack on the PS1 power stand.

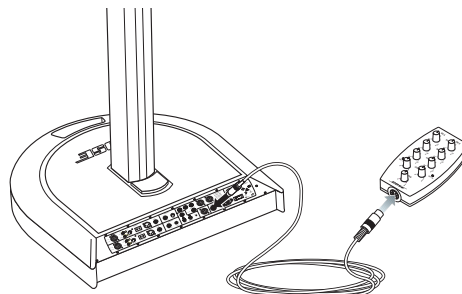

5. Place the R1 remote control within reach of your performance position. This will allow you to both hear your performance and to control it directly.

🎵 Note: If you power up the system without the R1 remote control, it will function as if all the knobs on the R1 remote control are at center position (12 o'clock).

6. Plug in the PS1 power stand and turn it on. Plug the female end of the power cord into the AC Mains jack on the PS1 power stand. Plug the other end into an AC (mains) receptacle.

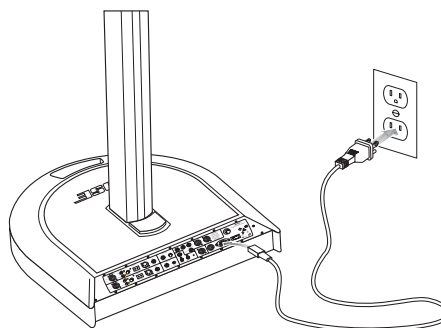

⚠ CAUTION: Bose recommends using a quality surge suppressor on all electronic equipment. Voltage variations and spikes can damage electronic components in any system. A quality suppressor, which can eliminate the vast majority of failures attributed to surges, may be purchased at electronics stores.

Your Personalized Amplification System™ product is now set up and ready for the addition of other equipment.

- See “Connecting a B1 bass module to the PS1 power stand (optional)” on page 12.
- See “Using an effects processor” on page 19.

Disassembly

WARNING: Before disassembly, turn the power off and then remove the AC power cord and all other cables from the PS1 power stand.

Remove the top L1 Cylindrical Radiator™ loudspeaker section

Place one foot on the PS1 power stand to support your back. Firmly grasp the top section with one hand. Using your other hand, press the release button with your thumb and remove the top section from the bottom section.

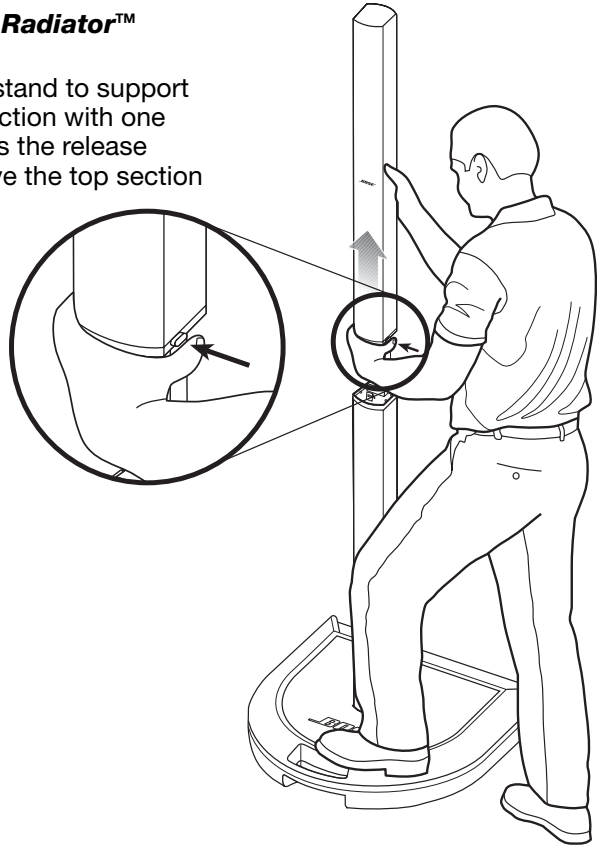

Remove the bottom L1 Cylindrical Radiator™ loudspeaker section

Using your foot, push down on the PS1 power stand treadle and lift the bottom L1 Cylindrical Radiator™ loudspeaker section up and out of the PS1 power stand.

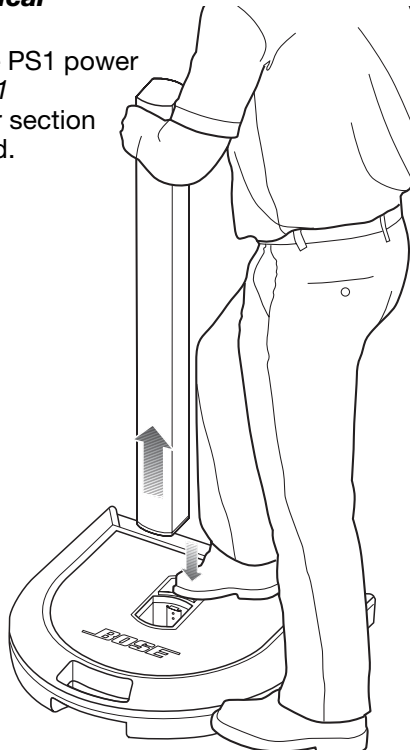

Connecting a B1 bass module to the PS1 power stand (optional)

The **B1 Bass Module (Amp 3 OUT)** jack on the PS1 power stand can adequately drive one or two B1 bass modules. B1 bass modules can be placed on the floor vertically or horizontally. Up to four modules can be stacked when placed horizontally (Figure 1).

⚠ CAUTION: Do not connect more than two B1 bass modules to the **B1 Bass Module (Amp 3 OUT)** jack on the PS1 power stand. Driving more than two B1 bass modules from the **B1 Bass Module (Amp 3 OUT)** output will improperly load the amplifier in the PS1 power stand, resulting in less than full system performance.

⚠ CAUTION: Only B1 bass modules should be used in the **B1 Bass Module (Amp 3 OUT)** jack.

Figure 5

Bass module orientations

B1 bass modules can be placed vertically or horizontally

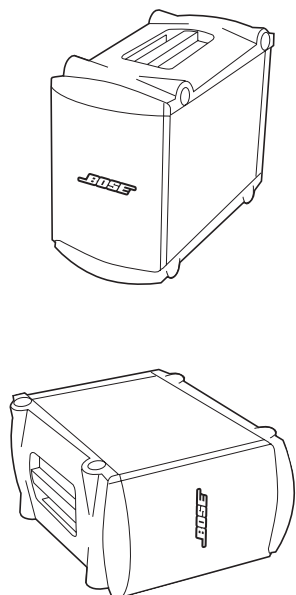

B1 bass modules can be stacked in a column of up to four, maximum

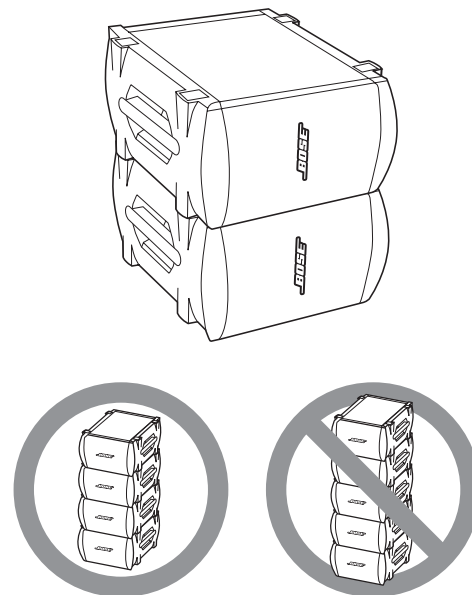

Connecting one B1 bass module

Insert one end of the B1 bass module 4-wire cable into one of the jacks on the rear panel of the B1 bass module. Insert the other end of the 4-wire cable into the **B1 Bass Module (Amp 3 OUT)** jack on the PS1 power stand connector panel.

Figure 6

B1 bass module

To connect, push the plug into the jack and rotate it clockwise to lock it.

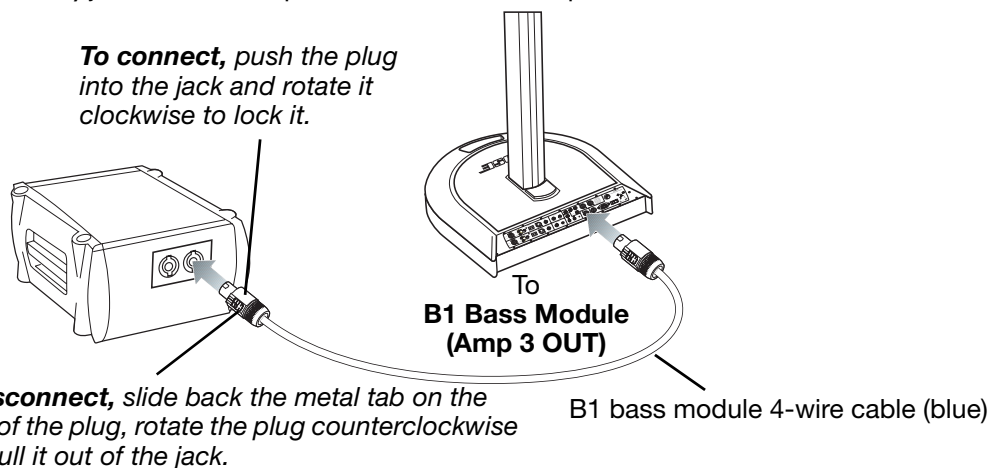

🎵 Note: The B1 bass module connector will click softly upon being properly engaged.

⚠ CAUTION: A B1 bass module cannot be shared between two PS1 power stands.

Connecting two B1 bass modules

Connect the first B1 bass module to the PS1 power stand as shown in “Connecting one B1 bass module.”

Insert one end of the second B1 bass module cable into the unused jack on the rear panel of the first B1 bass module. Insert the other end of the cable into one of the jacks on the rear panel of the second B1 bass module.

⚠ CAUTION: Do not connect more than two B1 bass modules to the **B1 Bass Module (Amp 3 OUT)** jack on the PS1 power stand. Driving more than two B1 bass modules from the **B1 Bass Module (Amp 3 OUT)** output will improperly load the amplifier in the PS1 power stand resulting in poor system performance.

🎵 Note: Use only the supplied (blue) B1 bass module 4-wire cable to connect B1 bass modules to the PS1 power stand. The PS1 power stand uses the signals on two of the four wires to automatically sense how many B1 bass modules are connected to it. **DO NOT SUBSTITUTE** the supplied cable with a 2-wire speaker cable.

Figure 7

Installation of two B1 bass modules

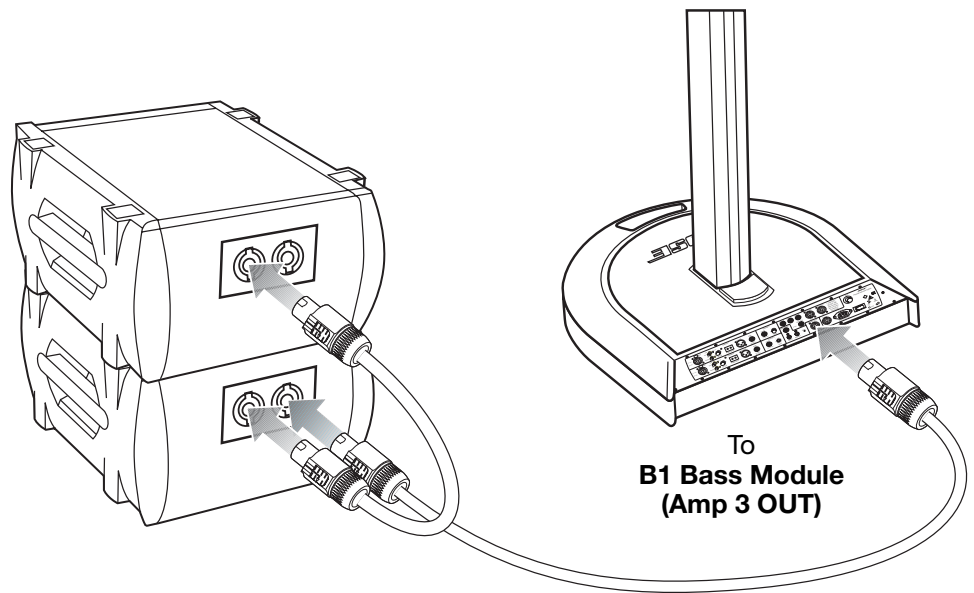

Channel 1/2 connections and controls

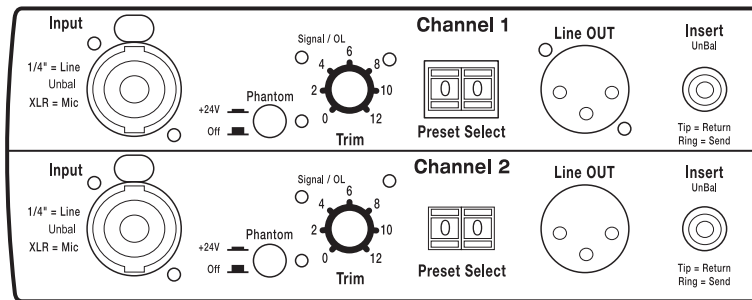

- Input** Combination XLR (mic) or 1/4-inch phone connector unbalanced (line) input. Inserting a male XLR connector sends the input signal to a balanced microphone preamplifier. Inserting a 1/4-inch phone plug sends the input signal to an unbalanced high-impedance line-level circuit which is suitable for most instruments such as active or passive guitars or basses, keyboards, etc. Both inputs can be adjusted with the **Trim** control.
- Trim 0 to 12** Controls the input level.
- Signal/OL** Indicates signal presence (green) or signal overload (red).
- Phantom Off/+24V** When depressed turns on the +24V phantom power. The LED lights when phantom power is on.
- Preset Select** Selects a comprehensive channel equalization, which results in a “normal” or useful sound when the product is used with commonly available equipment such as microphones, musical instruments or sound processors. The selectable settings from 00 to 99 apply only to channels 1 and 2. Settings are identical on both channels but are independently selected. See the preset guide inside the PS1 power stand panel door for a list of available presets.
- Line OUT** XLR output for sending to external recording equipment or to conventional sound mixing consoles (for using the Bose approach in large venues).
- Insert** A TRS line input/output for connecting to external equipment, such as digital effects processors.

🎵 **Note:** Use a stereo plug in the **Insert** jack for connecting send and return signals. The ring connects to the “Send”; and the tip connects to the “Return”.

Channel 3/4 connections and controls

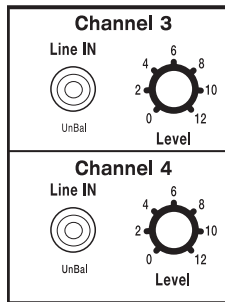

Line IN 1/4-inch phone connector unbalanced line input
Level 0 to 12 Controls the source input level

Power amp patch, bass, remote and AC power connections

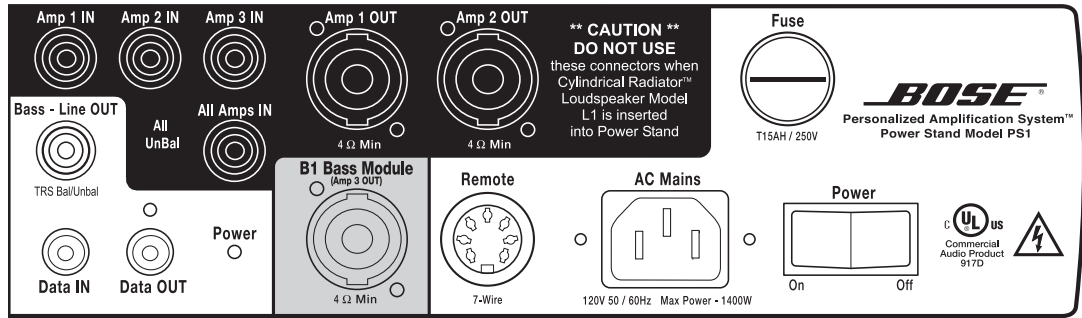

Used only when an L1 Cylindrical Radiator™ loudspeaker is NOT installed in the PS1 power stand.

- Amp 1 IN**..... Amplifier 1 input jack
- Amp 2 IN**..... Amplifier 2 input jack
- Amp 3 IN**..... Amplifier 3 input jack
- All Amps IN** Input jack to all amplifiers
- Amp 1 OUT**..... Amplifier 1 output jack
- Amp 2 OUT**..... Amplifier 2 output jack

B1 Bass Module (Amp 3 OUT)..... Bass output (amplifier 3 output) jack. Used to drive one or two B1 bass modules

Bass - Line OUT Balanced or unbalanced bass signal output for extended bass configurations

♪ **Note:** For more information on extended bass configurations, visit www.bose.com/musicians.

Data IN Digital data input. Used for updating product software

Data OUT Channel 1/2 digital output

Remote..... Input connection for the R1 remote control

AC Mains..... 3-conductor power cord connections

Fuse..... AC power fuse

On/Off..... PS1 power stand on/off switch

R1 remote control features

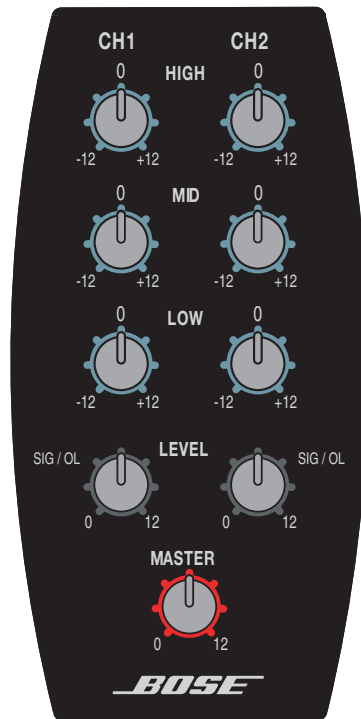

CH1/CH2 HIGH -12 to +12.....Cuts (-) or boosts (+) high-frequency sounds

CH1/CH2 MID -12 to +12.....Cuts (-) or boosts (+) mid-frequency sounds

CH1/CH2 LOW -12 to +12.....Cuts (-) or boosts (+) low-frequency sounds

CH1/CH2 LEVEL 0 to 12.....Adjusts the channel's volume level

MASTER 0 to 12.....Adjusts volume level of all channels

Producing individualized sound

This product will produce sound whether it is properly adjusted or not. However, if you take a few moments to follow a simple startup procedure, you can optimize the sound for a superior presentation based on your performance style and preferences.

Unless you make big changes in how you perform, this is typically a one-time event.

1. Set all **Trim** and **Level** controls on the PS1 power stand to zero (0).
2. Set the **MASTER** and all **LEVEL** controls on the R1 remote control to zero (0).
3. Set the **Power** switch to **On**.

⚠ CAUTION: *The peak inrush current for the system is approximately 32 amps. If more than one system is plugged into the same AC circuit, make sure you stagger the turn-on times. This can prevent tripping the circuit breaker or blowing the house mains fuse.*

4. Plug your microphone or instrument into the **Channel 1 or 2 Input** jack. If phantom power is required for your microphone (condenser or electret/condenser type), depress the **Phantom** power button.

♪ Note: *You can dial in a preset to improve the tone of many commonly used microphones and musical instruments. See the preset list inside the rear panel door for a list of supported instruments.*

5. Sing or play as loud as you would in a performance while following steps **6** and **7**.
6. Adjust the **Trim** control so that the **Signal/OL** indicator goes from unlit to green, and finally to occasionally blinking red. Make sure that your instrument is at the highest volume setting that you are planning to use. For vocalists, sing as loud as you would during the performance to achieve the maximum expected input signal.
7. Adjust the **LEVEL** control on the R1 remote control and make the **SIG/OL** indicator go from unlit to green, and finally to occasionally blinking red.

That's it! You're done! When you go to your concert or show:

- Use the **CH 1 and 2 LEVEL** controls on the R1 remote control to adjust the **Channel 1 and 2** volume level.
- Use the **MASTER** control on the R1 remote control to adjust the volume level of all outputs.
- Use the **HIGH, MID, and LOW** equalization controls on the R1 remote control to adjust the timbre of your sound.

Initially, keep the R1 remote control close at hand. This allows you to conveniently adjust the volume level when you first start playing. Later, you can move it out of the way or backstage once the system is performing the way you want it to.

♪ Note: *For more information on presets and amplifying the true sound of your instrument(s), please visit www.bose.com/musicians.*

Using input channels 3 and 4

The **Channel 3** and **4** inputs are optimized for 0 dB line-level signals, such as the signals from an effects processor, mixer, or CD player. Simply connect the equipment to the PS1 power stand and raise the output level using the **Channel 3 and 4 Level** control on the rear panel of the PS1 power stand.

Using an effects processor

IMPORTANT: When using an effects processor, determine and use the proper connection method (serial or parallel) for your application. Some effects **MUST** be hooked up in serial.

Serial connection method

With the serial method, the complete signal is routed directly into one or more effects processors. Serially connected effects processors are connected in a chain and the signal is processed sequentially. Nearly all “stomp boxes” for guitars work this way, such as, an overdrive followed by a reverb.

In a serial effect hookup, the order in which effects are connected together matters. For example, it makes a big difference whether you run first through the overdrive and then the reverb, or first through the reverb and then through the overdrive.

♪ **Note:** Always connect electronic equalizers, compressors, and limiters in serial.

Parallel connection method

The parallel method is mainly implemented in conventional mixers through “aux” or “effect” send/return connections and controls. Effects processors get the original (unprocessed) signal as an input. The output of effects processors is then added together and summed with the original clean signal. There is a component of the original signal present in the output, such as reverb and delay, which are used for vocals.

♪ **Note:** The parallel method mixes the original signal with the processed version. In the case of an equalizer, this generates highly undesirable interference and potential phase cancellation. Many digital effects processors have an internal processing delay, which is applied to the signal, even if no effect setting is applied. Mixing this delayed output with the original signal can result in unintended comb filtering.

Using a serial effects connection with the PS1 power stand

🎵 **Note:** Connecting an effects unit in serial requires a TRS split “insert” cable (with a ¼-inch TRS connector on one side, and two mono ¼-inch phone connectors on the other). This type of cable is readily available at most musical instrument stores and on the Internet.

1. Insert the TRS plug into the **Channel 1 Insert** jack on the PS1 power stand.
2. Connect the ¼-inch mono plug (labeled “send”, “ring”, or “right”) to the input of the effects processor.
3. Connect the other ¼-inch mono plug (labeled “return”, “tip”, or “left”) to the output of the effects processor.
4. Adjust the effects level and mix of the effects processor.

🎵 **Note:** A very high output from the effects processor can overload the input of the PS1 power stand. If the **LED** on the remote turns red, even if the channel **LEVEL** control on the R1 remote control is below the 12 o'clock position, reduce the output level of your effects processor.

🎵 **Note:** The effects processor does interrupt the audio path. This may result in no audio output if the effects processor is turned off. To use a “clean” signal, do not turn the effects processor off, but put it in bypass mode.

Figure 8

Using a serial effects connection

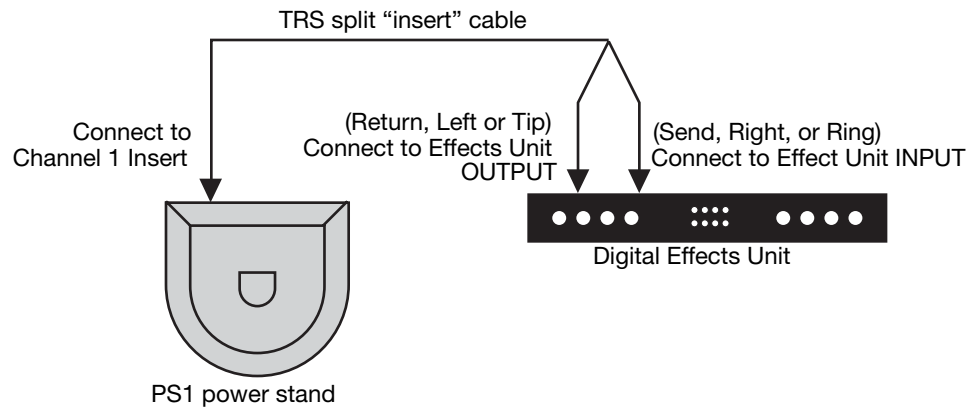

Using parallel effects connection with the PS1 power stand

🎵 **Note:** Connecting an effects unit in parallel requires one 1/4-inch unbalanced (instrument) cable, one mono 1/4-inch phone (M) to dual mono 1/4-inch phone (F) “Y” cable adaptor, and one TRS split “insert” cable (with a 1/4-inch TRS connector on one side and two mono 1/4-inch phone connectors on the other).

1. Insert the TRS plug into the **Channel 1 Insert** jack on the PS1 power stand.
2. Connect both 1/4-inch plugs from the “insert” cable into both receptacles on the “Y” cable adaptor.
3. Connect the plug of the “Y” cable adapter into the input of the effects processor.
4. Connect the 1/4-inch unbalanced (instrument) cable from the output of the effects processor to **Channel 3 Line IN** of the PS1 power stand.
5. Set the effects level of the processor to full and turn the mix level of the effects processor to full “wet”.
6. Adjust the **Channel 3 Level** control of the PS1 power stand for the desirable effects mix.

Figure 9

Using a parallel effects connection

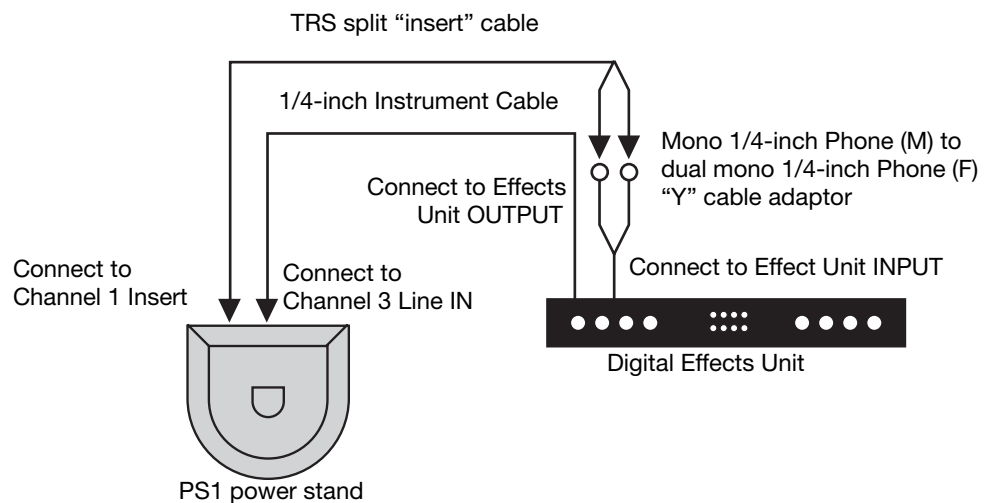

Troubleshooting

If you experience problems while using this product, try the following solutions. If you still can't solve the problem, please call the Bose® Live Music Product and Technical Support Team direct at 877-335-2673 to arrange for service.

Recommended troubleshooting tools:

- Portable voltmeter
- Cable tester
- AC outlet tester
- XLR and ¼-inch phone plug cables
- B1 bass module 4-wire cable (blue)
- Spare T15AH fuses
- Spare AC power cord

Problem	What to do
System is plugged in, power switch is on, but power LED is off	<ul style="list-style-type: none"> • Make sure you have power at the AC outlet. Try operating a lamp or other equipment from the same AC outlet or test the outlet using an AC outlet tester. • Make sure the PS1 power stand's power cord plug is fully inserted into the AC outlet. • Check the line fuse on the PS1 power stand.
Power LED is on (green), but no sound	<ul style="list-style-type: none"> • Make sure volume control is turned up on your instrument. • Make sure the applicable level control is turned up (Trim, or Channel 3/4 Level on the PS1 power stand; CH 1/2 LEVEL and MASTER level on the R1 remote control). • Make sure your instrument is plugged into the Channel 1/2 Input or Channel 3/4 Input jack. • Connect your instrument to the PS1 power stand using a different cable. • Plug your instrument into a different amplifier to make sure the instrument is working.
Power LED is red while the PS1 power stand is on	<ul style="list-style-type: none"> • Please call Bose Live Music Customer Support at (877) 335-2673 for assistance.
House circuit breaker keeps tripping	<ul style="list-style-type: none"> • If you have more than one PS1 power stand plugged into the same AC circuit, stagger the turn-on times. Each PS1 power stand has an inrush current of about 32 amps when turned on. • If you have more than three PS1 power stands plugged into a single 15 amp circuit, move some systems to another AC circuit. Each PS1 power stand can draw 5 amps or more when playing at high volumes for long periods of time.
With nothing plugged into the audio input or output connectors on the rear panel of the PS1 power stand, a slight <i>hum</i> or <i>buzz</i> is heard from the L1 or B1	<ul style="list-style-type: none"> • Using an AC outlet tester, test the AC outlet that the PS1 power stand is plugged into for reversed or open (hot, neutral, and/or ground) contacts. • If using an extension cord, make sure that the cord is also tested as above.
B1 bass module is plugged in, but no bass audio is heard	<ul style="list-style-type: none"> • Make sure you are using the (blue) B1 bass module 4-wire cable included with the B1 bass module. • Make sure that the B1 bass module cable is plugged into the B1 Bass Module (Amp 3 OUT) jack on the PS1 power stand. • Try a different 4-wire cable. • Check that the B1 bass module cable connectors are fully engaged in the jacks. • If available, try a different B1 bass module.
B1 bass module sounds out of balance with the system	<ul style="list-style-type: none"> • Make sure you are using the (blue) B1 bass module 4-wire cable included with the B1 bass module package. • Make sure that the B1 bass module grille is facing forward toward the musicians and audience.

Troubleshooting

Problem	What to do
No mid/high sounds heard from the <i>L1 Cylindrical Radiator™</i> loudspeaker	<ul style="list-style-type: none"> • Make sure <i>L1 Cylindrical Radiator™</i> loudspeakers are firmly seated in their connectors. • Make sure connections are not bent or broken. • Try cleaning the contacts on the <i>L1 Cylindrical Radiator™</i> loudspeakers with electronic contact spray cleaner.
System momentarily mutes when changing presets or plugging/unplugging the B1 bass module	<ul style="list-style-type: none"> • This is a feature of the PS1 power stand that allows the user to hear that internal changes have been made.
Microphone sounds distorted	<ul style="list-style-type: none"> • Make sure the red clip light is not constantly on. If it is, lower the trim. • Try a different microphone. • Try your microphone on another PS1 power stand.
One of the four instruments plugged into the PS1 power stand is at a lower volume than the others	<ul style="list-style-type: none"> • If the instrument is plugged into Channel 3/4, use a direct box or high-to-low transformer (high impedance instruments, such as non-active guitars or basses, are not designed to be plugged directly into a low impedance input). • If the instrument's volume is still lower than the others, try a similar instrument in the same channel. If this solves the problem, your instrument may not be working correctly.
Line OUT signals on channels 1 and 2 are very loud when connected to another PS1 power stand or a mixer with only mic-level input	<ul style="list-style-type: none"> • The Line OUT jack operates at a +4dBu professional line level; It is meant to connect to compatible mixing consoles. • Use inline pads to reduce the signal gain to a manageable level. • Line OUT is not meant to be used with PS1 power stands. Some advanced configurations are detailed online at www.bose.com/musicians.
Line OUT signals on channels 1 and 2 are very noisy	<ul style="list-style-type: none"> • Check to make sure that the receiving device (mixer) is set up to receive a +4dBu level signal. • Try powering the receiving device from the same outlet as the PS1 power stand. • Try using an XLR ground-lift barrel adapter or direct box.
Third-party powered subwoofer sounds poor when connected to the Bass - Line OUT connector on the PS1 power stand	<ul style="list-style-type: none"> • Unplug any B1 bass modules that may be connected to the PS1 power stand. • The signal from the Bass - Line Out may be too high for the powered subwoofer, try attenuating the signal using commercially available direct boxes or in-line pad devices. • Try different connections to the third-party powered subwoofer such as balanced or unbalanced cabling and/or a direct box. • Check that the gain and input controls on the third-party powered subwoofer are set appropriately. • If using a powered subwoofer with an adjustable crossover, set the crossover to 180Hz.
B1 bass modules powered by a third-party power amplifier and connected to the Bass - Line OUT connector sounds poor	<ul style="list-style-type: none"> • Ensure that at least two B1 bass modules are powered directly from the PS1 power stand (connected to the PS1 power stand's B1 Bass Module (Amp 3 OUT) jack) and using the (blue) B1 bass module 4-wire cable. • Check the gain settings on the third-party power amplifier. The volume level of the B1 bass modules powered by the PS1 power stand should be similar to the bass modules powered by the external amplifier.

Problem	What to do
Microphone is encountering feedback	<ul style="list-style-type: none"> • Orient the microphone so that it is not pointing directly at its respective <i>L1 Cylindrical Radiator™</i> loudspeaker. • Try a different microphone. • Try a different position for the <i>L1 Cylindrical Radiator™</i> loudspeaker and/or vocalist on stage. • Increase the distance from the <i>L1 Cylindrical Radiator™</i> loudspeaker to the microphone. • Reduce the HIGH control on the R1 remote control for that microphone. • If using a vocal effects processor, make sure that it is not contributing to the feedback problem.
R1 remote control is not working	<ul style="list-style-type: none"> • Try a different 7-pin cable for the R1 remote control. • Make sure the R1 remote control cable is firmly seated in the jack on the remote and the PS1 power stand. • Try resetting the PS1 power stand: Turn the PS1 power stand off, wait 30 seconds, and turn back on.
Poor-sounding prerecorded stereo playback (using such devices as a CD player)	<ul style="list-style-type: none"> • Run both left and right stereo channels into separate channels in the PS1 power stand such as Channel 1 for left and Channel 2 for right. • Do not use a 1/8-inch stereo (F) to 1/4-inch stereo (M) adapter when connecting portable devices to a channel on the PS1 power stand. • Disable any extended bass or EQ features when using portable CD or MP3 players.

Customer service

For additional help in solving problems, contact Bose® Live Music Customer Service Product and Technical Support Team at (877) 335-2673 or visit our support area online at www.bose.com/musicians.

Cleaning your product

- You may clean the product enclosures using only a soft dry cloth.
- Do not use any solvents, chemicals, or cleaning solutions containing alcohol, ammonia or abrasives.
- Do not use any sprays near the product or allow liquids to spill into any openings.
- If necessary, you may carefully vacuum the grille assembly of the *L1 Cylindrical Radiator™* loudspeaker.

Limited Warranty and Registration

Your *Personalized Amplification System™* product is covered by a limited transferable warranty. Details of the warranty are provided with your product. Register your products online at www.bose.com/register or call 800-905-1044. Failure to do so will not affect your warranty rights.

Accessories

Visit www.bose.com/musicians, or call (800) 905-0886 for accessory information.

Mechanical

Dimensions

- **PS1 power stand:** 26.0"W x 26.0"D x 5.0"H (66 cm x 66 cm x 12.7 cm)
- **L1 Cylindrical Radiator™ loudspeaker (each section):**
3.5"W x 4.0"D x 43.0"H (8.9 cm x 10.5 cm x 109.2 cm)
- **R1 remote control:** 2.8"W x 5.6"D x 1.6"H (7.1 cm x 14.1 cm x 4.0 cm)
- **B1 bass module (optional):**
10.3"W x 18.0"D x 15.3"H (25.0 cm x 45.7 cm x 38.0 cm)

Weight

- **PS1 power stand:** 35 lb (16 kg)
- **Lower L1 Cylindrical Radiator™ loudspeaker:** 16.0 lb (7 kg)
- **Upper L1 Cylindrical Radiator™ loudspeaker:** 14.5 lb (6 kg)
- **R1 remote control:** 0.6 lb (0.27 kg)
- **B1 bass module (optional):** 28 lb (13 kg)

Electrical

Impedance

- **L1 Cylindrical Radiator™ loudspeaker:** 4Ω
- **B1 bass module (optional):** 8Ω

AC power rating

- **USA/Canada:** 100-127V ~ 50/60Hz 1400W
- **Peak inrush current:** 32A @ 120V ~ 60Hz

Audio Input/Output

- **Amplifier 1 output power (Amp 1 OUT):** 250W (rms, into 4Ω), assigned to upper L1 Cylindrical Radiator™ loudspeaker or the **Amp 1 OUT** connector
- **Amplifier 2 output power:** 250W (rms, into 4Ω), assigned to lower L1 Cylindrical Radiator™ loudspeaker or the **Amp 2 OUT** connector
- **Amplifier 3 output power:** 250W (rms, into 4Ω), assigned to one or two B1 bass modules using the **B1 Bass Module (Amp 3 OUT)** connector
- **Output level, Line OUT:** Balanced XLR connection, +4dBu
- **Output level, Bass-Line OUT:**
 - With a balanced TRS connection: -4dBu (nominal), +9dBu (max)
 - With an unbalanced TS connection: -10dBu (nominal), +3dBu (max)
- **Bass-Line OUT Frequency Response:**
 - With 1 or 2 B1 bass modules connected to **B1 Bass Module (Amp 3 OUT):** 40 -180Hz, compensated for B1 bass module
 - Without B1 bass modules connected to **B1 Bass Module (Amp 3 OUT):** 40 -180Hz, flat bandpass
- **Data Output:** 48KHz, S/PDIF compatible interface. L=Channel 1 output, R=Channel 2 output.





BOSE[®]
Better sound through research[®]

©2005 Bose Corporation, The Mountain,
Framingham, MA 01701-9168 USA
263976 AM Rev.03 CCM-001549

www.bose.com/musicians