

BOSE[®]



LIFESTYLE[®] 535/525 series II
home entertainment systems

LIFESTYLE[®] 235/135 series II
home entertainment systems

LIFESTYLE[®] 520/510
home theater systems

Operating Guide | Betjeningsvejledning | Bedienungsanleitung | Bedieningshandleiding
Guía de usuario | Käyttöopas | Notice d'utilisation | Manuale d'uso | Használati útmutató
Instrukcijski priručnik | Operação Guia | Bruksanvisning

Safety Information

Please read this guide

Please take the time to follow the instructions in this owner's guide carefully. It will help you set up and operate your system properly and enjoy its advanced features. Please save this guide for future reference.

All Bose products must be used in accordance with local, state, federal, and industry regulations.

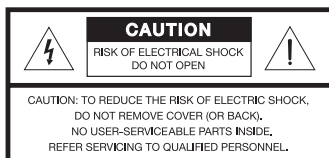

The lightning flash with arrowhead symbol within an equilateral triangle alerts the user to the presence of uninsulated, dangerous voltage within the system enclosure that may be of sufficient magnitude to constitute a risk of electric shock.



The exclamation point within an equilateral triangle, as marked on the system, is intended to alert the user to the presence of important operating and maintenance instructions in this owner's guide.



WARNING: Contains small parts which may be a choking hazard. Not suitable for children under age 3.



WARNING:

- To reduce the risk of fire or electrical shock, do not expose the product to rain or moisture.
- Do not expose this apparatus to dripping or splashing, and do not place objects filled with liquids, such as vases, on or near the apparatus. As with any electronic products, use care not to spill liquids into any part of the system. Liquids can cause a failure and/or a fire hazard.
- To prevent electric shock, match the wide blade of the line cord plug to the wide slot of the AC (mains) receptacle. Insert fully.
- Do not place any naked flame sources, such as lighted candles, on or near the apparatus.



CAUTION:

- Make no modifications to the system or accessories. Unauthorized alterations may compromise safety, regulatory compliance, and system performance.
- Long-term exposure to loud music may cause hearing damage. It is best to avoid extreme volume when using headphones, especially for extended periods.

Notes:

- The product label is located on the bottom or the back of the product.
- Where the mains plug or appliance coupler is used as the disconnect device, such disconnect device shall remain readily operable.
- The product must be used indoors. It is neither designed nor tested for use outdoors, in recreation vehicles, or on boats.
- This product is intended to be used only with the power supply provided.
- The speaker wire and interconnect cables included with the system are not approved for in-wall installation. Please check your local building codes for the correct type of wire and cable required for in-wall installation.



廢電池請回收

Please dispose of used batteries properly, following any local regulations.
Do not incinerate.



Bose Corporation hereby declares that this product is in compliance with the essential requirements and other relevant provisions of Directive 1999/5/EC and all other applicable EU directive requirements. The complete declaration of conformity can be found at: www.Bose.com/compliance.

Important Safety Instructions

1. Read these instructions.
2. Keep these instructions.
3. Heed all warnings.
4. Follow all instructions.
5. Do not use this apparatus near water.
6. Clean only with a dry cloth.
7. Do not block any ventilation openings. Install in accordance with the manufacturer's instructions.
8. Do not install near any heat sources such as radiators, heat registers, stoves, or other apparatus (including amplifiers) that produce heat.
9. Do not defeat the safety purpose of the polarized or grounding-type plug. A polarized plug has two blades with one wider than the other. A grounding type plug has two blades and a third grounding prong. The wide blade or the third prong are provided for your safety. If the provided plug does not fit into your outlet, consult an electrician for replacement of the obsolete outlet.
10. Protect the power cord from being walked on or pinched particularly at plugs, convenience receptacles, and the point where they exit from the apparatus.
11. Only use attachments/accessories specified by the manufacturer.
12.  Use only with the cart, stand, tripod, bracket, or table specified by the manufacturer, or sold with the apparatus. When a cart is used, use caution when moving the cart/apparatus combination to avoid injury from tip-over
13. Unplug this apparatus during lightning storms or when unused for long periods of time.
14. Refer all servicing to qualified personnel. Servicing is required when the apparatus has been damaged in a way, such as power-supply cord or plug is damaged, liquid has been spilled or objects have fallen into the apparatus, the apparatus has been exposed to rain or moisture, does not operate normally, or has been dropped.

Notice

This equipment has been tested and found to comply with the limits for a Class B digital device, pursuant to Part 15 of the FCC rules. These limits are designed to provide reasonable protection against harmful interference in a residential installation. This equipment generates, uses, and can radiate radio frequency energy and, if not installed and used in accordance with the instructions, may cause harmful interference to radio communications. However, there is no guarantee that interference will not occur in a particular installation. If this equipment does cause harmful interference to radio or television reception, which can be determined by turning the equipment off and on, you are encouraged to try to correct the interference by one or more of the following measures:

- Reorient or relocate the receiving antenna.
- Increase the separation between the equipment and receiver.
- Connect the equipment to an outlet on a different circuit than the one to which the receiver is connected.
- Consult the dealer or an experienced radio/TV technician for help.

Changes or modifications not expressly approved by Bose Corporation could void the user's authority to operate this equipment.

These devices comply with FCC and Industry Canada RF radiation exposure limits set forth for the general population. They must not be co-located or be operating in conjunction with any other antennas or transmitters.

These devices comply with Industry Canada license-exempt RSS standard(s). Operation is subject to the following two conditions: (1) This device may not cause interference, and (2) this device must accept any interference received, including interference that may cause undesired operation of the device.

Safety Information

Applicable only for:

- **LIFESTYLE® 535 and 525 series II home entertainment systems**
- **LIFESTYLE® 520 and 510 home theater systems**



Manufactured under license under U.S. Patent #'s: 5,956,674; 5,974,380; 6,487,535 & other U.S. and worldwide patents issued & pending. DTS, the Symbol, & DTS and the symbol together are registered trademarks & DTS Digital Surround and the DTS logos are trademarks of DTS, Inc. Product includes software. ©DTS, Inc. All Rights Reserved.

Applicable only for:

LIFESTYLE® 235 and 135 series II home entertainment systems



Manufactured under license under U.S. Patent #'s: 5,956,674; 5,974,380 and 6,487,535 & other worldwide patents issued & pending. DTS, the DTS Symbol and DTS+the DTS Symbol are registered trademarks & the DTS logos are trademarks of DTS, Inc. Product includes software. ©2010 DTS, Inc. All Rights Reserved.

Names and Contents of Toxic or Hazardous Substances or Elements						
Part Name	Toxic or Hazardous Substances and Elements					
	Lead (Pb)	Mercury (Hg)	Cadmium (Cd)	Hexavalent (CR(VI))	Polybrominated Biphenyl (PBB)	Polybrominated diphenylether (PBDE)
PCBs	X	0	0	0	0	0
Metal parts	X	0	0	0	0	0
Plastic parts	0	0	0	0	0	0
Speakers	X	0	0	0	0	0
Cables	X	0	0	0	0	0
0: Indicates that this toxic or hazardous substance contained in all of the homogeneous materials for this part is below the limit requirement in SJ/T 11363-2006.						
X: Indicates that this toxic or hazardous substance contained in at least one of the homogeneous materials used for this part is above the limit requirement in SJ/T 11363-2006.						



Manufactured under license from Dolby Laboratories. Dolby and the double-D symbol are trademarks of Dolby Laboratories.

Designed with UEI Technology™ Under License from Universal Electronics Inc. ©UEI 2000-2011.

The terms HDMI and the HDMI Logo are trademarks or registered trademarks of HDMI Licensing, LLC in the United States and other countries.

iPhone and iPod are trademarks of Apple, Inc., registered in the U.S. and other countries.

Xbox is a trademark of Microsoft Corporation.

TiVo is a trademark of TiVo, Inc. or its subsidiaries.

Other trademarks are property of their respective owners.

©2013 Bose Corporation. No part of this work may be reproduced, modified, distributed, or otherwise used without written permission.

Introduction

Welcome.....	7
System features.....	7
If you need help.....	7

Controls and Indicators

Remote Control.....	8
Using the remote	8
Navigation controls	9
Playback controls.....	9
Information display (535/525/235/135 series II systems only).....	10
Remote glow button.....	10
MORE buttons	11
Activating a MORE button function.....	11
Button function definitions	11
Control Console.....	13
Speaker Array (135 series II systems only).....	14
Acoustimass® Module (135 series II systems only)	14

Power On/Off Controls

Starting your system	15
Turning on your TV	15
Shutting down your system	15

Operating Your System Sources

Selecting a source	16
Watching TV	17
Using a set-top box.....	17
Using the tuner in your TV.....	17
Tuning to a TV station.....	17
Playing audio/video devices.....	18
Selecting the radio (535, 525, 235 and 135 series II systems only)	19
Tuning to a station.....	19
Storing a preset station	19
Recalling a preset station.....	19
Deleting a preset station	19
Optional radio tuner settings	19

Contents

Playing content from an iPod or iPhone
(535/525/235/135 series II systems only) 20

Using the front console inputs 21

- Front USB input 21
- Front Analog A/V input 22
- Front HDMI™ input 22

Changing the image view 22

Changing System Options

Using the system OPTIONS menu 23

OPTIONS menu 23

Changing Your System Setup

UNIFY® system overview 26

Using the UNIFY menu 26

Care and Maintenance

Troubleshooting 27

- Resetting the system 29
- Pairing the remote with the console 29
- Performing a system software update 30

Contacting customer service 30

Replacing the batteries 30

Cleaning 31

Limited warranty 31

Technical information 32

Licensing information 33

Please complete and retain for your records

The serial and model number can be found on the bottom panel of the product.

LIFESTYLE® model: _____

Control console serial number: _____

Acoustimass® serial number: _____

Speaker array serial number (135 Series II systems): _____

We suggest you keep your receipt with this owner's guide.

Welcome

Thank you for choosing a Bose® LIFESTYLE® system for your home. This elegant and easy-to-use system delivers superior performance for both music and video.

By now you should have successfully set up your system using the UNIFY® intelligent integration system and calibrated the sound for your room using the ADAPTiQ® audio calibration system.

This guide describes your new remote control and shows you how to operate your system and its connected devices.

System features

Features on all systems

- UNIFY intelligent integration system helps to easily add devices to your system
- 3D video capability (requires that you connect a 3D-capable TV and a 3D-capable Blu-ray Disc™ player, game console, cable box, or other source to your LIFESTYLE® system)
- ADAPTiQ audio calibration system that optimizes system performance for your room
- RF remote control
- HDMI® connectivity
- Video up-conversion to 1080p
- Photo viewing using a USB flash drive

Additional features on 535, 525, 235 and 135 series II systems only

- AM/FM radio
- Back panel connector for a 30-pin accessory dock (not included) compatible with iPod and iPhone devices

If you need help

If you experience any operating difficulties, be sure to check the troubleshooting table on page 27. You can solve the most common operating problems using the helpful tips provided there. If you need additional help or service for your product, please refer to the included contact sheet.

IMPORTANT! – Please register your product right away!

Registering your product enables you to receive notifications of system software updates to keep your product performing optimally. It also allows us to send you information about new products and special offers from Bose.

Please follow the instructions on your Product Registration Card to register. Failure to register will not affect your limited warranty rights or your eligibility to obtain system software updates.

Controls and Indicators

Remote Control

Using the remote

This advanced radio frequency remote works throughout the room. You do not need to aim it at the control console.

SOURCE – Displays and selects connected devices from the source list on your TV

Power – Turns your system on or off

Color functions – Activates color-related functions on connected sources such as Blu-ray Disc™ players and set-top boxes, and for Teletext

Internet – Activates Internet access on third-party devices such as Blu-ray Disc™ players and set-top boxes

Volume Up/Down – Increases (+) or decreases (-) the system volume

Mute – Mutes/unmutes system speakers

Image View – Changes how video appears

Numeric Keypad – Allows manual entry of channels and settings

Information Display – See page 10

TV Power – Turns your TV on or off

Teletext – Turns Teletext controls on and off

Navigation Controls – See page 9

MORE – Displays additional device-specific controls and information on your TV See page 11.

Channel Up/Down – Next or previous numbered channel or preset

Last Channel – Returns to last channel or preset

Playback Controls – See page 9

TV Input – Changes inputs on your TV



Navigation controls

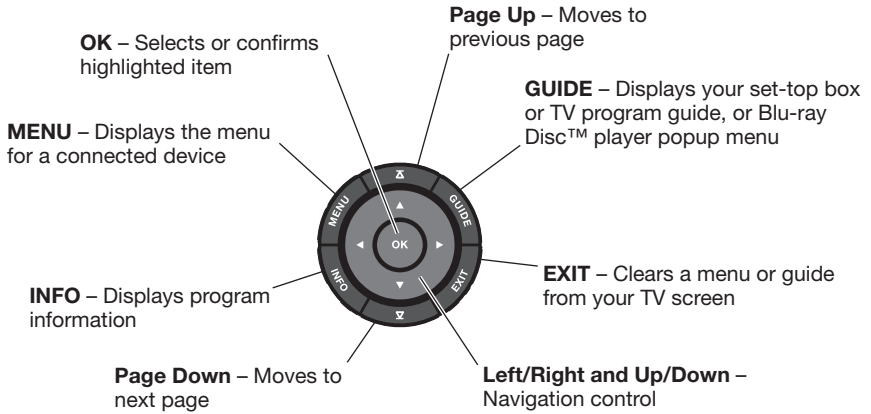

Note: See “Operating Your System Sources” on page 16 for more details on using navigation and playback controls with selected sources.

Playback controls

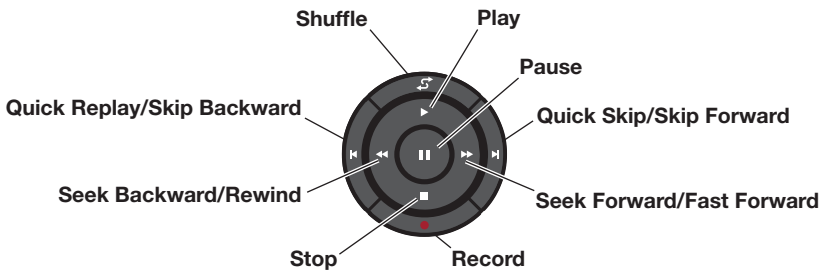

Controls and Indicators

Information display (535/525/235/135 series II systems only)

The display provides operating and system status information.

Examples:

Source identification



Volume



Radio tuner



iPod



Operating prompt

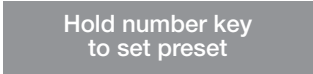







Remote glow button

Pressing the glow button  on the rear of the remote illuminates the remote buttons (and the display on 535/525/235/135 series II systems). The light turns off automatically after several seconds to prolong battery life.

To adjust the illumination level of the display:

Note: If the currently selected source is AM or FM, switch to any other source before making this adjustment. This prevents unintentionally deleting a radio preset.

1. Press and hold the  and **OK** buttons at the same time for 5 seconds.
2. Press the up  or down  navigation button to select Brightness or Contrast.
3. Press the left  or right  navigation button to decrease or increase the illumination level.
4. Press either the **OK** or  to return to normal operation.

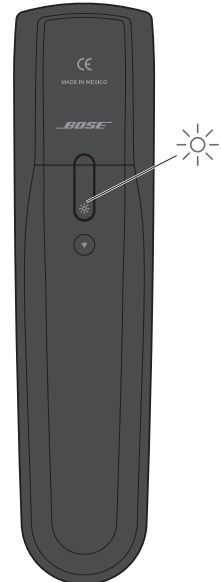

MORE buttons



Press the **MORE** button to display additional button functions along the top of your TV screen for the current source. The functions that appear depend on the selected source. Only 13 of the available buttons can be displayed. An arrow at the right or left of the buttons indicates if additional buttons are available.

When there are more than 13 buttons, an arrow appears either to the right or left of the displayed buttons telling you to scroll left or right to see the other buttons.

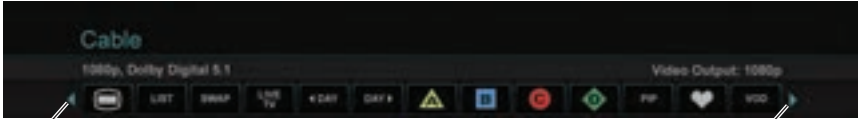

Indicates more buttons to the left. Move highlight left.

Indicates more buttons to the right. Move highlight right.

Activating a MORE button function

1. Press the remote **MORE** button.
2. Press the left ◀ or right ▶ navigation button to highlight the function you want to activate.
3. Press the remote **OK** button.

Button function definitions



Turns device power on/off.



Switches your TV to live programming.



Displays a list of favorite channels.



Switches between main features (from DVD to VCR, for example) on a combo device.



Displays program guide for next day.



Moves to the “Home” state of the device.



Displays program guide for previous day.



Selects a repeat option on the current source.



Displays playlist of recorded programs.



Switches tuners in a multi-tuner device.



Picture-in-picture mode.



Switches between TV and radio on a set-top box that provides both.



Video on demand.



Switches tuners in a multi-tuner device.

Controls and Indicators

Button function definitions (continued)

-  Allows you to enter a 3-digit number (Japan only).
-  Displays the OPTIONS menu. See “Changing System Options” on page 23.
-  Accesses the system menu for your set-top box.
-  Access the Top Menu (or Title Menu) on Blu-ray Disc™ players.
-  Accesses A, B, C, or D functions in an interactive program guide.
-  Accesses Xbox® functions.
-  Accesses data broadcast on a tuner device (Japan only).
-  Accesses PlayStation® functions.
-  Selects different types of video broadcast (EU only).
-  Allows you to rate certain content, such as a TiVo® program.
-  Accesses specific “tools” on Blu-ray Disc™ players or set-top boxes.

Control Console

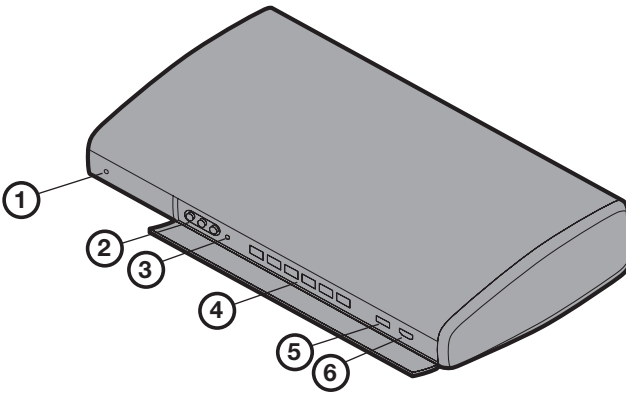

- ① **System status indicator**
 Red.....System is off (Standby)
 Blinking greenSystem is starting
 Solid greenSystem is on and ready to use
 Amber.....System is off or turning off, and when charging iPod or iPhone in the optional accessory dock (available from Bose)

- ② **Front A/V inputs**
 Used for temporarily connecting an audio/video device such as a camcorder.

- ③ **Headphones output**
 Accepts stereo headphones with a 3.5 mm stereo plug. Volume level is set by the volume controls.

- ④ **Control buttons**

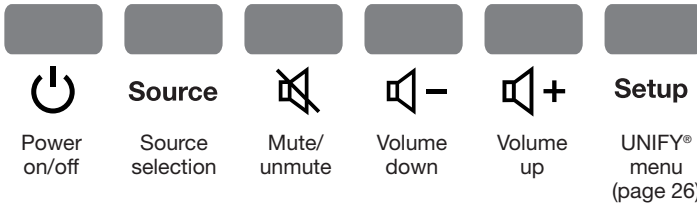

- ⑤ **Front USB input**
 Used for viewing photo files from a USB device including a digital camera. Also used for updating system software.

- ⑥ **Front HDMI™ input**
 Used for temporarily connecting an HDMI device such as a video camera.

Controls and Indicators

Speaker Array (135 series II systems only)

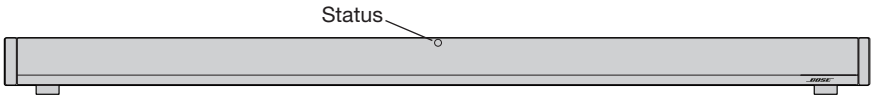

Status indicator:

- Off.....Speaker array and Acoustimass® module are connected
- Slow blinking orange.....Speaker array is available to make a wireless connection
- Fast blinking orange.....Speaker array is disconnected and trying to connect
- Solid red.....System error (Call Bose Customer Service)

Acoustimass® Module (135 series II systems only)

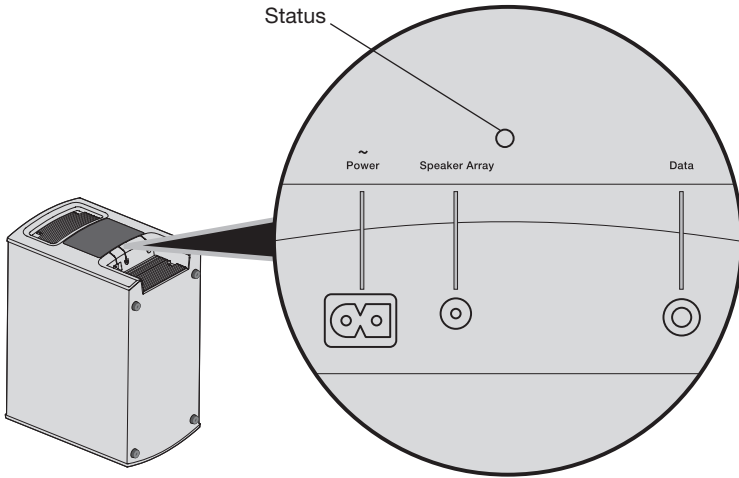

Status indicator:

- Solid orange.....Speaker array and Acoustimass module are connected
- Blinks every 3 secs.....Acoustimass module is disconnected from speaker array or speaker array is off (Acoustimass module standby)
- Slow blinking orange.....Acoustimass module is available to make a wireless connection
- Solid red.....System error (Call Bose Customer Service)

Starting your system

To start your system:



Press the **Power** button on the remote or the console.

In several seconds, the system status indicator on the console changes from blinking to solid green. The system is now ready to use.

To start your system and go directly to the SOURCE menu:

SOURCE

Press the **SOURCE** button on the remote control. This starts your system and opens the SOURCE menu on your TV screen.

To start your system and go directly to the UNIFY® menu:

Setup

Press the **Setup** button on the control console. This starts your system and opens the UNIFY® menu on your TV screen.

Note: To keep energy consumption to a minimum, the system operates in a power saving mode when it is off. This is why the system may take several seconds to start.

Turning on your TV

TV

If you programmed your remote during the initial setup using UNIFY, press the **TV Power** button on the remote control to turn on your TV. Otherwise, use the remote that came with your TV.

Shutting down your system



Press the **Power** button on the remote or on the control console.

The system will shut down automatically after a few seconds.

Note: If you decide to access the power controls for connected devices, automatic shutdown is stopped and you must complete the shutdown using the onscreen controls.

Operating Your System Sources

Selecting a source

The SOURCE menu allows you to select your sources and connected devices. The menu can display a maximum of 10 selections. When there are more than 10 selections, an arrow appears either at the top or bottom of the menu telling you to scroll up or down to see the other items.

1. Press the **SOURCE** button on the remote to display the list of connected devices on your TV.

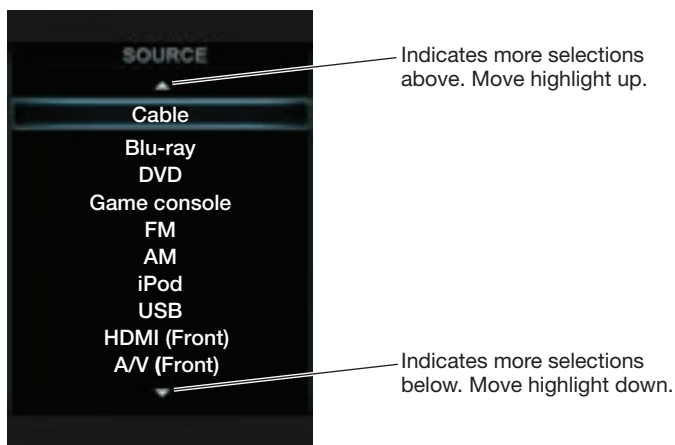

2. Keep pressing **SOURCE** to move the highlight down the list and select the source you want.
 - You can also use the up ▲ or down ▼ navigation buttons to select a source.
 - If you named a device during the setup process, the assigned name appears in the list. Unnamed devices appear as generic inputs such as “Input 1 (HDMI)” and “Input 2 (HDMI).”
 - If you select a source that is turned off, a message appears on the screen reminding you to turn on the source.

Note: When listening to audio sources, the system automatically enters Screensaver mode to prevent the risk of screen burn-in. Press any button on the LIFESTYLE remote to restore the picture. To disable the screensaver, see “Changing System Options” on page 23.

Note: The UNIFY® intelligent integration system sets up your LIFESTYLE® remote to control each of your devices. If one or more of these devices does not respond to the LIFESTYLE® remote, see “Troubleshooting” on page 27.

Watching TV

Your TV may be receiving its program content through a set-top box or the tuner built into your TV.

Note: Since most televisions come with an IR (infrared) remote, you may need to point the Bose® remote at your TV to operate it.

Using a set-top box

If you connected a cable, satellite, or other set-top box to your TV, it will appear in the SOURCE menu under the name you assigned it during the setup process.

1. Press the remote **SOURCE** button and select the device that provides your TV programs.
2. Tune to a station. See “Tuning to a TV station,” below.

Using the tuner in your TV

If you are using the tuner in your TV to receive TV programs:

1. Press the remote **SOURCE** button and select TV.
2. Press the **TV Input** button  to select the internal tuner in your TV.
3. Tune to a station. See “Tuning to a TV station,” below.

To return to using other sources, press the **TV Input** button  to first select the input for the Bose® system, then press the **SOURCE** button and select another source.

Tuning to a TV station

You can tune to a TV station using any of the following methods:



Enter the channel number on the keypad and press **OK**. Use the dash button for channel numbers using a dash or period.



Press **▲** (channel up) or **▼** (channel down) to change channels.
Press the **Last** button  to tune to last selected channel.





Press the **GUIDE** button. Use the navigation, page up/down, and **OK** buttons to select a station from the program guide.

Operating Your System Sources

Playing audio/video devices

During the interactive setup process, you may have connected a CD, DVD, DVR, Blu-ray Disc™ player, or other such device. These are typically connected to inputs 1-5.

If you programmed the LIFESTYLE® remote for the device, you can use the following controls to operate the selected device.

	MENU	Device menu (if available) or system setup menu
	GUIDE	Blu-ray Disc player pop-up menu
	INFO	Device information
	EXIT	Exit menu
	▲	Up one item
	▼	Down one item
	◀	Move left
	▶	Move right
	OK	Select
	△	Next page, channel, or disc
▽	Previous page, channel, or disc	
	▶	Play
	⏸	Pause
	■	Stop
	●	Record
	⏩	Fast forward or search forward
	⏮	Fast rewind or search reverse
	⏪	Quick skip or skip forward
	⏪	Quick replay or skip backward
	↻	Shuffle mode

Selecting the radio (535, 525, 235 and 135 series II systems only)

1. Press the **SOURCE** button.
2. Keep pressing the **SOURCE** button to select FM or AM in the SOURCE list.

Tuning to a station



- Press **▶** (increase) or **◀** (decrease) to tune up or down the frequency band.

Or,

- Press **▶▶** (seek next) or **◀◀** (seek previous) to find the next/previous strong station.

Storing a preset station

The built-in radio tuner can store up to 25 FM and 25 AM preset stations.

1. Tune to a radio station.
2. For presets 1-9, press and hold the number key. For 10-25, press and hold the **OK** button to store the station in the next available preset.

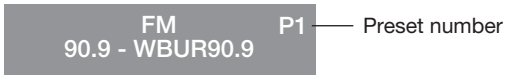

Recalling a preset station



Press **▲** (channel up) or **▼** (channel down) to go to the next or previous preset.



For quick access to presets 1-9, press the number key of the preset.

Deleting a preset station

1. Recall the preset station you want to delete.
2. Press and hold the **OK** button until the preset number disappears from the display.

Optional radio tuner settings

1. Press the **MORE** button  and select **OPTIONS**.
2. From the **OPTIONS** menu (see page 24 for details) you can select:
 - Current Station: Allow Stereo, Stereo Off
 - RDS: On, Off

Operating Your System Sources

Playing content from an iPod or iPhone (535, 525, 235, and 135 series II systems only)

Your LIFESTYLE® system can play audio and video from an iPod or iPhone using the 30-pin accessory dock (not included) available from Bose.

Your iPod or iPhone menus and content appear on the left side of your screen as shown in the following example. The “Now Playing” track appears on the right.

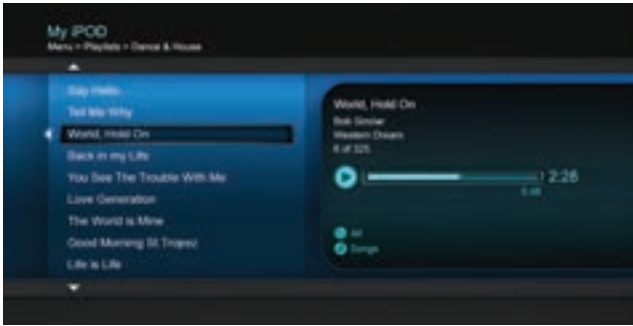

The following controls are available to operate your connected iPod.

	MENU	Up one menu level (press and hold to go to top menu level). If playing video, pause and return to menu
		Up one page
		Down one page
		Up one menu item (press and hold to scroll quickly)
		Down one menu item (press and hold to scroll quickly)
		Up one menu level. If playing video, pause and return to menu
		Down one menu level
		Down one menu level
		Play
		Pause
		Stop
		Next track or audio bookmark
		Previous track or audio bookmark
		Fast forward
		Fast rewind
		Shuffle mode

Using the front console inputs

The front of the console provides analog A/V inputs plus a USB and an HDMI® input. These inputs appear in the SOURCE menu as A/V (Front), USB, and HDMI (Front) only when a device is connected. These inputs are provided for temporarily connecting devices such as digital cameras and video cameras.

Front USB input

Your LIFESTYLE® system can display photo files (.jpg or .jpeg format only) from a USB storage device.

When selecting the USB source, folders appear at the top of the list on the left followed by single image files. Selecting a folder displays its contents.

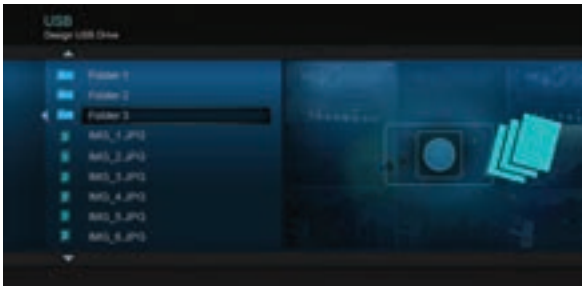

Use the following controls for viewing digital photos.

	▲	Up one menu item (press and hold to repeat)
	▼	Down one menu item (press and hold to repeat)
	◀	Up one folder level, or exit and return to browsing folders (if viewing a slideshow)
	MENU	Up one folder level, or exit and return to browsing folders (if viewing a slideshow)
	▶	Down one folder level
	OK	Down one folder level (if a folder is highlighted), or play slideshow (if a photo file is highlighted)
	△	Up nine items
	▽	Down nine items
	EXIT	Exit slideshow and return to browsing folders
	▶	Play slideshow of highlighted folder
	⏸	Pause slideshow
	■	Exit slideshow and return to browsing folders
	▶	Next image
	◀	Previous image

Operating Your System Sources

Front Analog A/V input

You can use this input for devices that have composite video and left/right audio outputs. The Bose® remote does not control a device connected to this input. You need to use the controls on the device itself or the remote that came with it.

Front HDMI input

You can use this input for devices that have an HDMI output. The Bose remote does not control a device connected to this input. You need to use the controls on the device itself or the remote that came with it.

Changing the image view



Press the image view button to display a menu of video formatting choices. Continue to press this button to highlight your choice.

Your TV picture will change momentarily after you select a format.

Note: When displaying 3D video, the Image View button does not display a menu of video formatting choices. The shape of the video cannot be changed when watching 3D video.



Normal Leaves original video image unchanged.



Auto-wide Fills width of the screen without cropping any content.



Stretch 1 Stretches video image evenly from the center.



Stretch 2 Stretches the edges of the video image much more than the center portion of the image.



Zoom Enlarges the video image (press the up/down navigation buttons to vertically offset the image on your screen).



Grey Bars Places vertical gray bars on the left and right of a standard-definition video image.

Using the system OPTIONS menu

The number of items appearing in the OPTIONS menu depends on which source is currently selected.

1. Press the remote **MORE** button .
2. Press the left ◀ or right ▶ navigation button and highlight OPTIONS. Press the remote **OK** button to display the OPTIONS menu for the current source as shown in the following example.



3. Press the up ▲ or down ▼ navigation button and highlight the option you want to change.
4. Press the left ◀ or right ▶ navigation button and select the setting.
5. Press the remote **EXIT** button when done.

OPTIONS menu

Factory settings are in bold type.

Option	Available Settings
Source Sound (Not available on 235 series II or 135 series II systems)	Original Plays stereo audio when stereo audio is received from the source Recommended Plays 5-channel audio whether 2- or 5-channel audio is received from the source Alternative Plays 5-channel audio when either stereo or 5-channel audio is received from the source Enhanced Mono Plays simulated surround sound when monaural audio is received from the source
Current Station (Not available on 520 or 510 systems)	Allow Stereo Allows stereo sound from the current stereo FM radio station Stereo Off Changes the current station to mono, which can help when tuning to a weak radio station

Changing System Options

Option	Available Settings
RDS (Not available on 520 or 510 systems)	On Displays RDS information on the remote Off No RDS information on the remote
Game Mode	On Reduces video processing and delay Off Normal performance
Audio Compression	Off No change to audio track Enhance Dialog Enhances sound output so you can hear movie dialogs more distinctly Smart Volume Reduces the range of volume levels in a movie soundtrack so the difference between extremely loud outbursts and soft sounds is less noticeable
Audio Track	Track 1 Selects track 1 from an external audio stream with multiple audio tracks Track 2 Selects track 2 from an external audio stream with multiple audio tracks Both Tracks Selects tracks 1 and 2 from an external audio stream Not Available Automatically selected when only one track is received
Volume Offset	Increases the volume level of the selected source relative to other sources (0 to 10)
Source Overscan (2D only)	On Applies video overscan to the current video source Off Video source unaffected Note: When a 3D source is playing, "Not Available" is displayed instead of an overscan value.
System Bass	Adjusts bass level: -9 to Normal to +6 (After ADAPTiQ® calibration) -14 to Normal to +14 (No ADAPTiQ calibration)
System Treble	Adjusts treble level: -9 to Normal to +6 (after ADAPTiQ® calibration) -14 to Normal to +14 (no ADAPTiQ calibration)
2D AV Sync (2D only)	Adjusts the audio delay to synchronize audio with the 2D video: -2 to Normal to +8
3D (3D only)	Sets the 3D image to display correctly with the appropriate 3D glasses Automatic Sets the correct 3D image format automatically Side by side Selects the side by side format Top and bottom Selects the top/bottom format
3D AV Sync (3D only)	Adjusts the audio delay to synchronize audio with the 3D video -2 to Normal to +10
Power Down	Normal System shuts down without presenting the Power Down Menu Power Down Menu System presents the Power Down Menu when shutting down
Screensaver	On Displays a screensaver after 20 minutes of no user activity when playing audio-only sources Off Disables screensaver mode

Changing System Options

Option	Available Settings
Rear Speakers (Not available on 235 series II or 135 series II systems)	Adjusts the volume level of the rear speakers relative to front speakers: (-10 to Normal to +6) Note: This option is unavailable if the Speakers option is set to Stereo (2) or Front (3).
Center Speaker (Not available on 235 series II or 135 series II systems)	Adjusts the volume level of the front center speaker relative to other speakers: -8 to Normal to +8 Note: This option is unavailable if the Speakers option is set to Stereo (2)
Speakers (Not available on 235 series II or 135 series II systems)	Stereo (2) Activates only front left and right speakers Front (3) Activates only front left, center, and right speakers Surround (5) Activates all front and rear speakers
Volume on TV	On Enables the system to display the volume level meter and mute indicator on your TV Off Prevents the display of the volume level meter and mute indicator
TV Speakers	On Sends HDMI™ audio to your TV (audio from the TV is not affected by plugging headphones into the control console or by pressing Mute or Volume on the remote) Off Sends HDMI audio to the LIFESTYLE® system speakers
Video Output (2D only)	Changes the resolution (Standard Definition/720p/1080i/1080p) of the video signal sent to your TV (only settings supported by your TV appear as options) Note: When a 3D source is playing, the output resolution always matches the resolution of the connected 3D source. Video Output then shows the automatically-set output resolution, and you cannot change resolutions while a 3D source is playing.
Automatic Off	Enabled The system, including the Bose® link second zone, automatically turns itself off after four hours of inactivity (no user interaction) Disabled The system will not turn itself off automatically Note: The system will automatically turn off after 15 minutes after you no longer hear audio or see video from a video source or you no longer hear audio from an audio source. The 4-hour Automatic Off setting does not affect this function.

Changing Your System Setup

UNIFY® system overview

The UNIFY intelligent integration system guides you through the initial process of setting up and configuring your system. It helps you choose the right cables and inputs, and program the LIFESTYLE® remote to operate your connected devices.

After completing the initial setup, you can use the UNIFY system at any time to change your system setup and configuration.

Using the UNIFY menu

To display the UNIFY menu on your TV, press the **Setup** button on the front of the control console. Using the navigation buttons on the remote, select the function you want and follow the instructions on the screen.

Menu item	What you can do
Resume initial setup	If your initial setup is incomplete, you can return to the UNIFY setup process at the last completed event.
Restart initial setup	If your initial setup is incomplete, you can start the UNIFY setup process from the beginning.
Reconnect Acoustimass® (135 series II systems only)	Follow the onscreen instructions to reconnect the speaker array with the Acoustimass module.
Language	Change the language of the onscreen display.
ADAPTiQ®	Start the ADAPTiQ audio calibration process. After ADAPTiQ has been run, this menu item allows you to disable or enable ADAPTiQ.
TV setup	After your TV is connected to the console, you can: <ul style="list-style-type: none">• Program the LIFESTYLE® remote to control your TV• Manually enter remote control IR device codes• Replace your TV• Add, change, or remove the TV audio connection
Source setup	For sources connected to Input 1-5 of the control console, you can: <ul style="list-style-type: none">• Change the name of the device• Program your remote to control the device and add the IR emitter• Manually enter remote control IR device codes• Remove the device• Add or change the type of audio or video connection
Add a new device	After your initial setup is complete, you can add another device or accessory to your system.
Update	Used to perform a system software update (see “Performing a system software update” on page 30 for more information).
Teach mode	This item is used to send IR codes to program a learning remote.
Exit UNIFY	Closes the UNIFY menu and returns you to the last source selected.

Troubleshooting



Problem	What to do
The system is not responding to initial operation of my Bose® remote	<ul style="list-style-type: none"> • Make sure the control console is turned on. • Check to see if the remote batteries are installed correctly or need replacement. See “Replacing the batteries” on page 30. • Reset the system. See “Resetting the system” on page 29. • Press any remote key and watch the system status indicator on the control console. It should blink with each press. If not, see “Pairing the remote with the console” on page 29 and follow the procedure.
The Bose remote does not control a device I added during the initial setup	<ul style="list-style-type: none"> • Try setting up the device again. Press the Setup button on the control console. Select the device options and follow the onscreen instructions to set up the device again. • Your system may need a software update. See “Performing a system software update” on page 30.
The video connection from a connected source is less than optimum	To change a video connection, press the Setup button on the control console and select the device setup options. Follow the onscreen instructions.
System doesn't do anything	<ul style="list-style-type: none"> • Make sure the AC power cord is inserted securely into the power supply. • Make sure the Acoustimass® module and the power supply are fully plugged into a live AC (mains) outlet. • (135 series II systems only) Make sure the speaker array is plugged into a live AC (mains) outlet. • Select a connected device from the SOURCE menu. • Reset the system. See “Resetting the system” on page 29.
No sound	<ul style="list-style-type: none"> • Make sure the Acoustimass module is plugged into a live AC (mains) outlet. • (135 series II systems only) Make sure the speaker array is plugged into a live AC (mains) outlet. • Increase the volume. • Press the Mute button and make sure your system is not muted. • Check the input connections on the control console. Make sure that you have selected the right source. • Make sure that the audio input cable is firmly plugged into the Audio Out connector (not Bose link) on the control console and the other end is firmly seated into the Media Center connector on the Acoustimass module. • (135 series II systems only) Make sure that the audio input cable is firmly plugged into the Audio Out connector (not Bose link) on the control console and the other end is firmly seated into the Audio In connector on the speaker array. • (135 series II systems only) Try moving any possible sources of wireless interference, such as a wireless computer network router, another wireless device, or a microwave oven, further away from the system. • For radio operation, connect the FM and AM antennas. • Reset the system. See “Resetting the system” on page 29.

Care and Maintenance

Problem	What to do
Sound quality has changed and speaker array status indicator is blinking orange (135 series II systems only).	Press the Setup button on the control console and select the "Reconnect Acoustimass" menu item. Follow the onscreen instructions.
TV does not respond to remote commands (135 series II systems only)	<ul style="list-style-type: none"> • Make sure the speaker array is not blocking the IR sensor on the TV. Change the position of the TV and speaker array so that the IR sensor is not blocked. • For details on the location of the TV's IR sensor, refer to the owner's guide that came with your TV.
Intermittent bass (135 series II systems only)	<ul style="list-style-type: none"> • Check that the status indicator on the Acoustimass® module is orange and not blinking. • If the speaker array status indicator is blinking orange: <ul style="list-style-type: none"> – Check that the Acoustimass module is plugged into a live AC wall outlet and the status indicator is glowing orange. – Press the Setup button on the control console and select the "Reconnect Acoustimass" menu item. Follow the onscreen instructions. – Try moving any possible sources of wireless interference, such as a wireless computer network router, another wireless device, or a microwave oven, further away from the system.
Sound is impaired by a loud hum or buzz, which may be electrical in nature	Contact Bose® Customer Service to determine if and how other electrical devices in the room may be creating unwanted signals, and to obtain possible remedies.
Radio does not work	<ul style="list-style-type: none"> • Make sure antennas are connected properly. • Move AM antenna at least 20 inches (50 cm) from the control console and Acoustimass module. • Adjust antenna position to improve reception. • Make sure the AM antenna is in an upright position. • Move antennas farther from control console, TV, or other electronic equipment. • Select another station. You may be in an area of weak signal coverage for some stations.
FM sound is distorted	<ul style="list-style-type: none"> • Adjust antenna position to reduce interference. • Fully extend the FM antenna.
Picture is blurry when viewing 3D content	<ul style="list-style-type: none"> • If your 3D glasses are of the active type, make sure they are turned on. • Try changing the 3D system option to a different setting. • If the problem persists, make sure the speaker array is not blocking the IR sensor on the TV. Change the position of the TV and speaker array so that the IR sensor is not blocked. • For details on the location of the TV's IR sensor, refer to the owner's guide that came with your TV.
Sound is distorted	<ul style="list-style-type: none"> • Make sure the audio input cable is not damaged and the connections are secure on both ends. • Reduce the volume output level from any external devices connected to the control console. • (135 series II systems only) Remove the protective film from the trim and grille on the speaker array and the front of the Acoustimass module.



Problem	What to do
No sound from a connected device	<ul style="list-style-type: none"> • Check the connections. • If using a coaxial or optical audio connection, make sure you have not made both types of connections to the same input on the control console. • Make sure that device is turned on. • Refer to the owner's manual that came with the device.
No TV picture, but audio is heard	<ul style="list-style-type: none"> • Check the TV video input selection. Make sure it is correct for the video source. • Make sure video cables are securely connected.
A connected device does not respond consistently to remote commands	Try connecting the included external IR emitter to the control console. For guidance, press the Setup button on the control console. Select the device options and follow the onscreen instructions.
Intermittent audio drop-outs heard on coaxial digital audio inputs	Contact Bose Customer Service to request a composite video cable that can be used for the coaxial digital audio connection.

Resetting the system

1. Press and hold the **Power** button  on the control console for 5 seconds or until the system status indicator on the control console changes to red. The system status indicator on the control console changes to red when the system shuts down.
2. Release the **Power** button  on the control console to restart the system. The system status indicator changes to blinking green and then solid green when the system is on and ready to use.
3. If you still cannot operate the system using the remote, try the next procedure to pair the remote with the control console.

Pairing the remote with the console

You may need to perform this procedure if you are replacing a remote or if troubleshooting instructions recommend it.

1. Make sure your system is on. If not, press the **Power** button  on the control console.
2. Hold the remote close to the control console.
3. Press and hold both the **Mute** button  on the control console and the **OK** button on the remote at the same time for five seconds. The system status indicator blinks when pairing is complete.
4. Press any remote button and verify that the system status indicator on the control console blinks with each button press.

Care and Maintenance

Performing a system software update

System software updates may be available periodically from Bose and can be downloaded over the Internet to the USB drive included with your system.

1. Press the **Setup** button on the front of the control console to display the UNIFY® menu.
2. Using the remote navigation buttons, select Update.
3. Follow the instructions on the screen.

Note: To make sure your Bose remote is updated, hold the remote near the front of the control console while it is being updated.

Contacting customer service

For additional help in solving problems, contact Bose® Customer Service. See the address sheet included in the carton.

Replacing the batteries

Replace all four batteries when you notice a marked decrease in the range or response of your remote control, or when you see the low battery icon on the remote display.

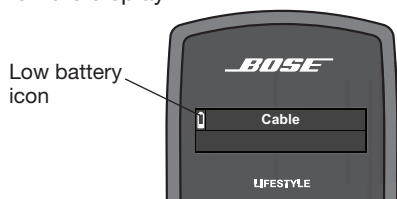

1. Slide the battery compartment cover off the back of the remote control.
AA (IEC-LR6) batteries (4)

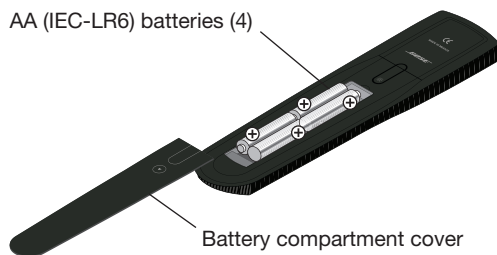

2. Remove the old batteries.
3. Install four new AA (IEC-LR6) 1.5V batteries, matching the polarity markings (+ and -) to the markings inside the battery compartment.
4. Slide the battery cover back into place.

Cleaning

You can wipe the outside surfaces using a soft dry cloth. You can also lightly vacuum the speaker grilles.

CAUTIONS:

- DO NOT use solvents, chemicals, or sprays for cleaning.
 - DO NOT allow liquids to spill or objects to drop into any openings.
-

Limited warranty

Your LIFESTYLE® system is covered by a limited warranty. See your product registration card for details. Please be sure to fill out the information section on the card and mail it to Bose. Failure to do so will not affect your limited warranty.

Care and Maintenance

Technical information

Remote control

Frequency: 2.4 GHz

Range: 33 ft (10 m)

Control console power supply rating

AC input: 100-240V \sim 50/60 Hz, 1.0A (1,0A)

DC output: 12V --- 35W Max.

Acoustimass[®] module rating for LIFESTYLE[®] 535, 525, 520, 510 and 235 series II systems

USA/Canada: 100-120V \sim 50/60 Hz 350W

International: 220-240V \sim 50/60 Hz 350W

Dual voltage: 100-120/220-240V \sim 50/60 Hz 350W

Acoustimass[®] module rating for LIFESTYLE[®] 135 series II systems only

AC input power: 100-240V \sim 50/60 Hz 150W

Speaker array rating for LIFESTYLE[®] 135 series II systems only

AC input power: 100-240V \sim 50/60 Hz 60W

Wireless connection rating for LIFESTYLE[®] 135 series II systems only

Output power: 5 mW @ 2400-2480 MHz

Range: 20 ft (6.1 m)

Licensing information

This product contains one or more free or open source software programs originating from third parties and distributed as part of the STLinux software package. Visit www.stlinux.com/download for further details. This free and open source software is subject to the terms of the GNU General Public License, GNU Library/Lesser General Public License, or other different and/or additional copyright licenses, notices, and disclaimers. To understand your rights under these licenses, please refer to the specific terms of the licenses, notices, and disclaimers, which are provided to you in an electronic file, named “licenses.pdf,” located within the product’s control console. To read this file, you will need a computer with a USB port and a software program that can view .pdf files.

To download “licenses.pdf” from your product’s control console:

1. Press and hold the Setup button on the front of the control console to display the System Information screen.
2. Insert a USB drive (there should be one included in your system package) into the USB input on the front of the control console.
3. Press the OK button on the remote control to copy the file to the USB drive. This download process should be completed within 30 seconds. You may then remove the USB drive.
4. To read the file “licenses.pdf,” plug the USB drive into a computer with a USB port, navigate to the USB root directory, and open “licenses.pdf” with a software program that can view .pdf files.

To receive a copy of the source code for the open source software programs included in this product, please mail your written request to: Licensing Manager, Mailstop 6A2, Bose Corporation, The Mountain, Framingham, MA 01701-9168. Bose Corporation will distribute such source code to you on a disc for a charge covering the cost of performing such distribution, such as the cost of media, shipping and handling. All of the above referenced licenses, notices, and disclaimers are reproduced and available with such source code. This offer is valid for a period of three (3) years following the date of distribution of this product by Bose Corporation.



372639-0010

BOSE[®]
Better sound through research[®]

©2013 Bose Corporation, The Mountain,
Framingham, MA 01701-9168 USA
AM372639 Rev. 00