

START HERE

BOSE

SOUNDTOUCH[®] SA-5
AMPLIFIER

Please read and keep all safety and use instructions. • Læs og opbevar venligst alle sikkerheds- og brugsinstruktioner. • Bitte lesen Sie alle Sicherheitshinweise und Gebrauchsanleitungen durch und bewahren Sie sie auf. • Lees alle veiligheidsinstructies en de gebruiksaanwijzing door en bewaar deze. • Lea y conserve todas las instrucciones de uso y seguridad. • Lue ja säilytä kaikki turvallisuus- ja käyttöohjeet. • Lisez toutes les consignes de sécurité et les instructions d'utilisation, et conservez-les en lieu sûr. • Leggere e conservare tutte le istruzioni per la sicurezza e per l'uso. • Kérjük, olvassa el és tartsa be a biztonsági és használati utasításokat. • Les og ta vare på alle sikkerhets- og bruksinstruksjoner. • Należy zapoznać się ze wszystkimi zaleceniami dotyczącymi bezpieczeństwa oraz instrukcjami użytkowania i zachować je. • Leia e guarde todas as instruções de segurança importantes. • Läs igenom och spara alla anvisningar om säkerhet och användning. • โปรดอ่านและเก็บคำแนะนำด้านความปลอดภัยและการใช้งานทั้งหมดไว้ • 모든 안전 및 사용 지침을 읽고 보관하십시오. • 請閱讀並保管好所有安全和使用指示。 • 安全上の留意項目および使用方法をよく読み、それに従ってください。 • يُرجى قراءة كل التعليمات الخاصة بالسلامة والاستخدام والاحتفاظ بها.

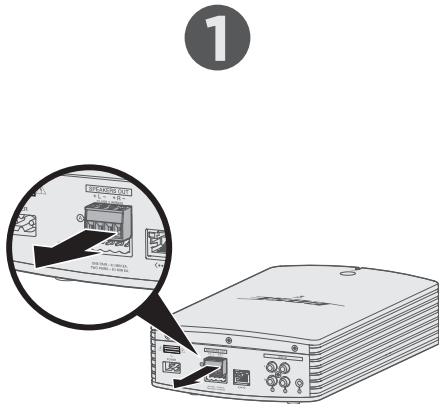

Remove terminal block A.

Each terminal block accepts one pair of speakers.

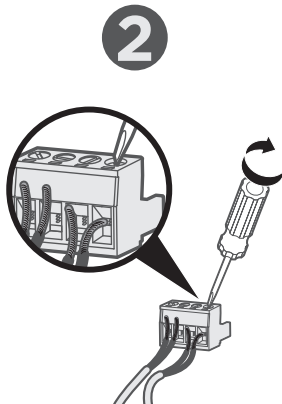

Connect and secure the speaker wires to terminal block A.

1. Insert the left speaker's marked wire into the **+ L** positive terminal and the plain wire into the **L -** negative terminal.
2. Insert the right speaker's marked wire into the **+ R** positive terminal and the plain wire into the **R -** negative terminal.

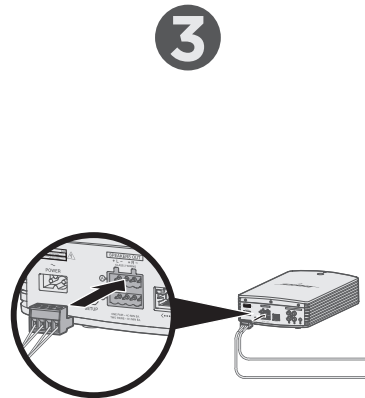

Reinsert terminal block A.

To connect a second pair of speakers, repeat steps 1-3 using terminal block B.

Note: Refer to your speaker owner's guide for instructions on connecting the other end of the speaker wires to the speakers. You can connect up to two pairs of unpowered speakers.

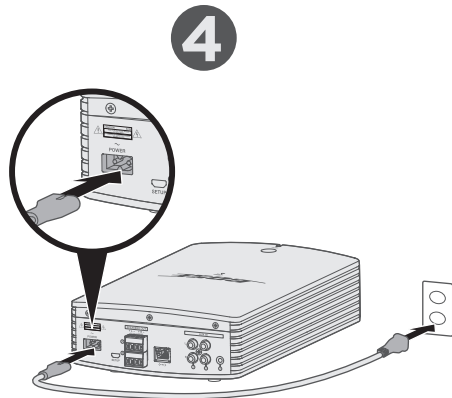

Connect to power.

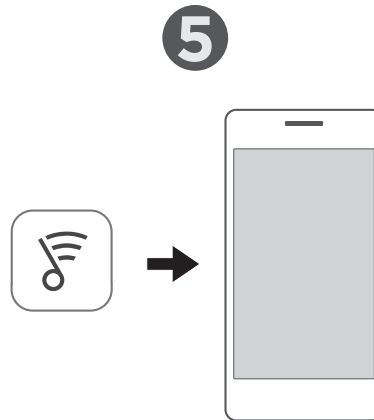

Download the SoundTouch® app.*

*If using a computer, go to global.Bose.com/Support/SA5 to download the app.

Have questions? global.Bose.com/Support/SA5

Wall-mounting

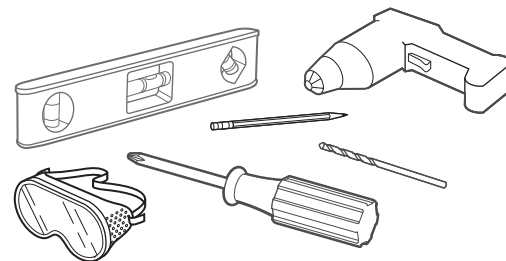
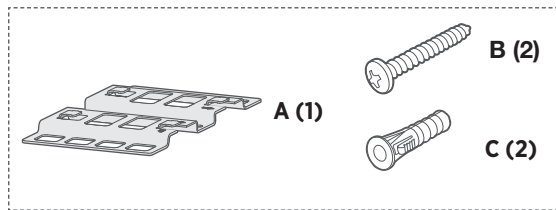

Item	Wood	Wallboard
Wall thickness	$\frac{3}{4}$ in. (19 mm) or thicker	$\frac{3}{8}$ in. (9.5 mm) or thicker
Drill bit	$\frac{3}{32}$ in. (2.38 mm)	$\frac{1}{4}$ in. (6.35 mm)
Phillips-head wood screws (2)	#10 x $1\frac{1}{4}$ in. (M5 x 32 mm)	#10 x $1\frac{1}{4}$ in. (M5 x 32 mm)
Plastic anchors (2)	Not used	#10 (M5) plastic anchors

1

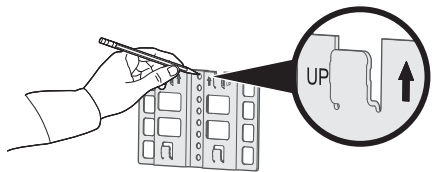

2

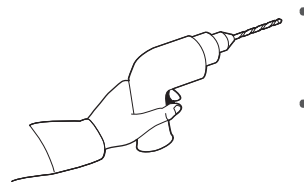

3

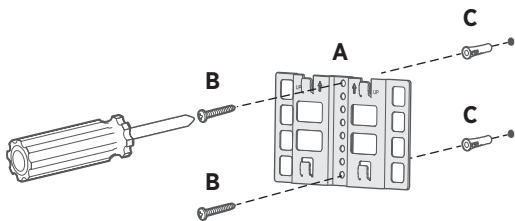

4

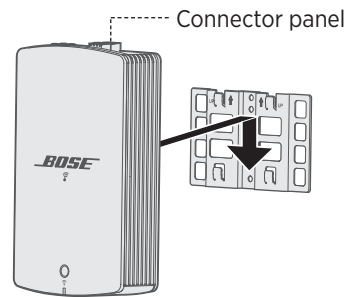

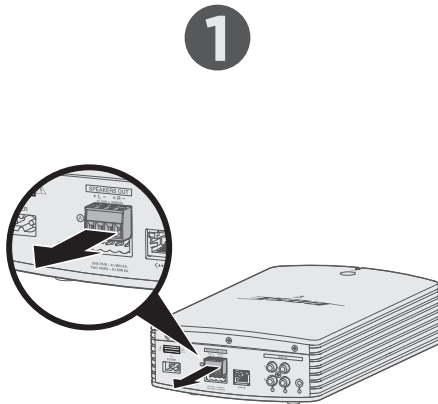

Fjern klemrække A.

Hver klemrække kan indeholde et sæt højttalere.

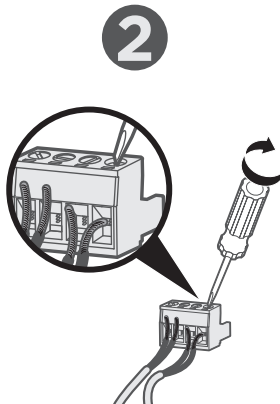

Tilslut og fastgør højttalerkablerne til klemrække A.

1. Sæt den venstre højttalers markerede kabel i den positive **+ L** klemrække og det almindelige kabel i den negative **L -** terminalklemrække.
2. Sæt den venstre højttalers markerede kabel i den positive **+ R** klemrække og det almindelige kabel i den negative **R -** klemrække.

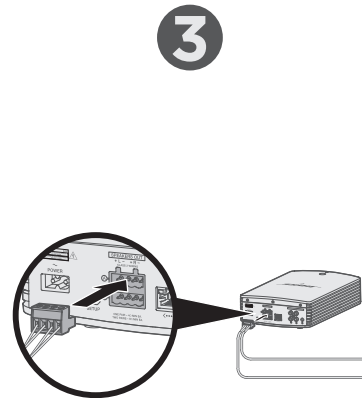

Isæt klemrække A igen.

Tilslut det andet sæt højttalere ved at gentage trin 1 - 3 og bruge klemrække B.

Bemærk: Der henvises til højttalernes brugervejledning for oplysninger om, hvordan den anden ende af højttalerkablerne slutes til højttalerne. Du kan tilslutte op til to sæt ikke-strømforsynede højttalere.

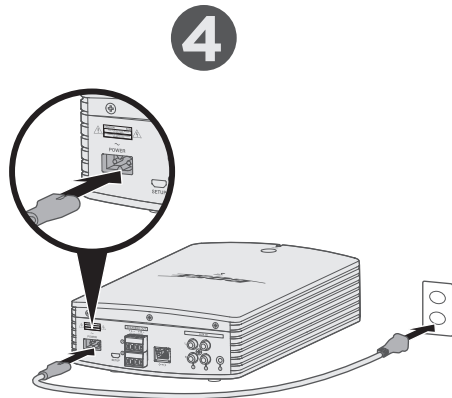

Slut til lysnettet.

5



Download SoundTouch®-app'en.*

*Hvis du bruger en computer, skal du gå til global.Bose.com/Support/SA5 for at downloade app'en.

Har du spørgsmål? global.Bose.com/Support/SA5

Vægmontering

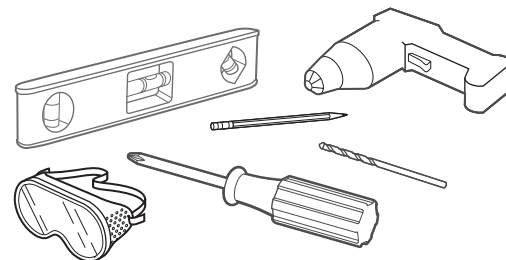
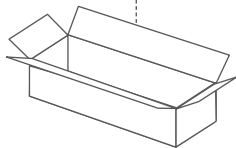
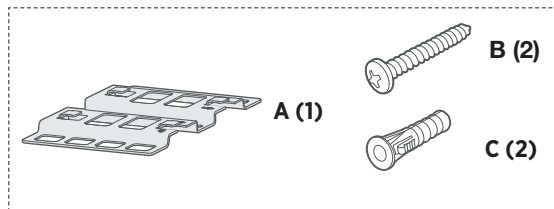

Enhed	Træ	Vægplade
Væggens tykkelse	$\frac{3}{4}$ tommer (19 mm) eller tykkere	$\frac{3}{8}$ tommer (9,5 mm) eller tykkere
Bor	$\frac{3}{32}$ tommer (2,38 mm)	$\frac{1}{4}$ tommer (6,35 mm)
Træskruer til stjerneskruetrækker (2)	#10 x 1 $\frac{1}{4}$ " (M5 x 32 mm)	#10 x 1 $\frac{1}{4}$ " (M5 x 32 mm)
Plastikankre (2)	Ikke i brug	#10 (M5) plastikankre

1

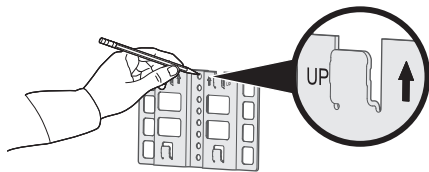

2

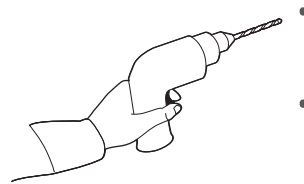

3

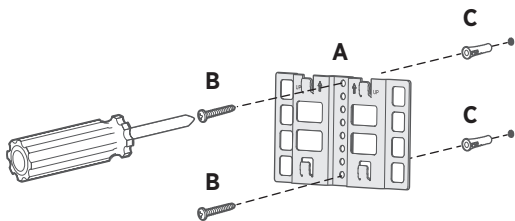

4

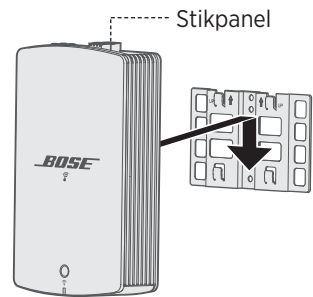

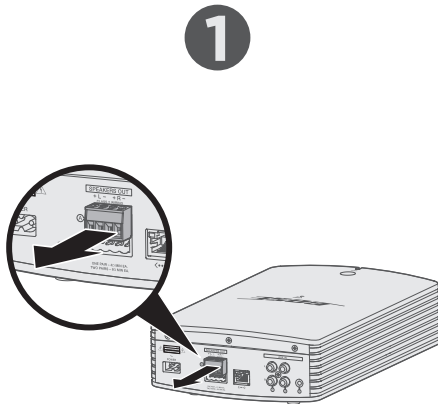

Entfernen Sie Klemmenblock A.

An jeden Klemmenblock kann ein Lautsprecherpaar angeschlossen werden.

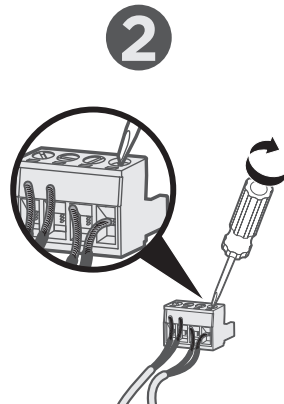

Schließen Sie die Lautsprecheradern an Klemmenblock A an.

1. Stecken Sie die markierte Ader des linken Lautsprechers an die positive Klemme **+ L** und die unmarkierte Ader an die negative Klemme **L -**.
2. Stecken Sie die unmarkierte Ader des rechten Lautsprechers an die positive Klemme **+ R** und die unmarkierte Ader an die negative Klemme **R -**.

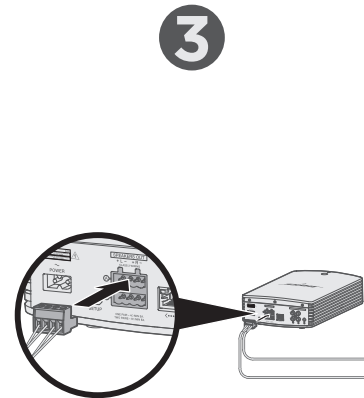

Setzen Sie Klemmenblock A wieder ein.

Um ein zweites Lautsprecherpaar anzuschließen, wiederholen Sie die Schritte 1 bis 3 mit Klemmenblock B.

Hinweis: In der Bedienungsanleitung Ihres Lautsprechers finden Sie eine Anleitung zum Anschließen des anderen Endes der Lautsprecheradern an die Lautsprecher. Sie können bis zu zwei Passivlautsprecherpaare anschließen.

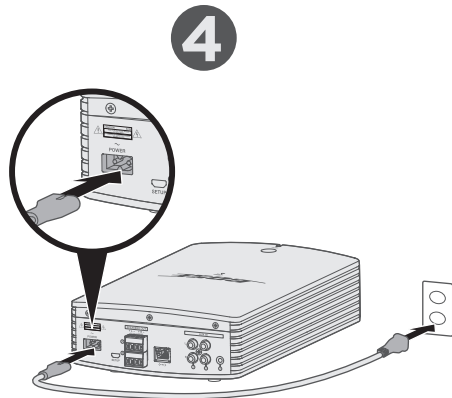

Anschluss an das Stromnetz.

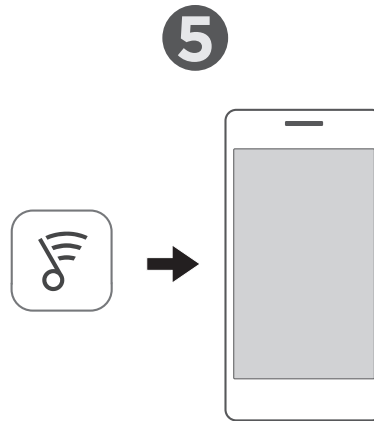

SoundTouch®-App herunterladen.*

*Wenn Sie einen Computer verwenden, gehen Sie zu global.Bose.com/Support/SA5, um die App herunterzuladen.

Haben Sie Fragen? global.Bose.com/Support/SA5

Wandmontage

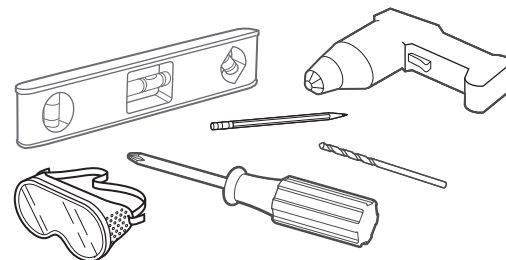
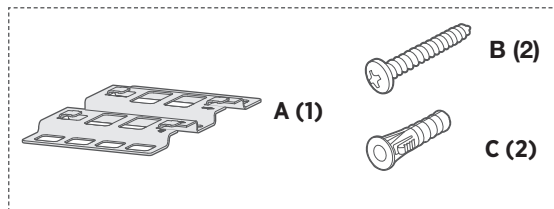

Menüpunkt	Holz	Gipskartonplatten
Wandstärke	19 mm oder stärker	9,5 mm oder stärker
Bohrerbit	2,38 mm	6,35 mm
Sechskant-Holzschrauben (2)	M5 x 32 mm	M5 x 32 mm
Kunststoffdübel (2)	Nicht verwendet	M5 Kunststoffdübel

1

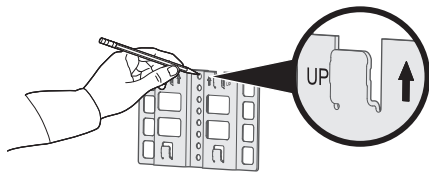

2

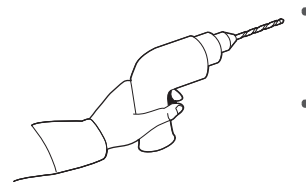

3

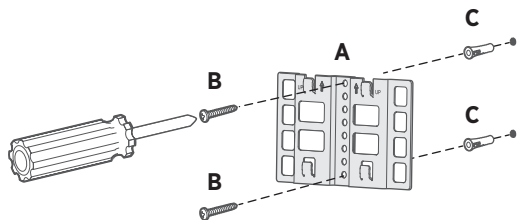

4

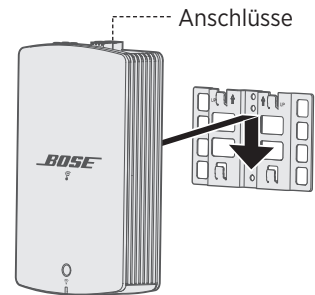

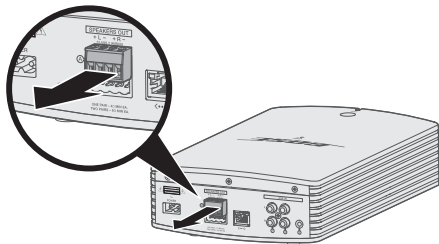
1

Verwijder klemblok A.

Op elk klein blok kan één paar luidsprekers worden aangesloten.

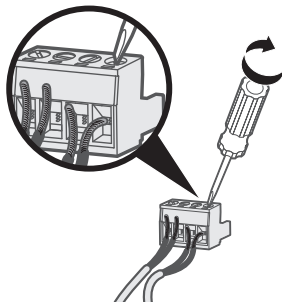
2

Sluit de luidsprekerkabels aan op klemblok A en zet ze vast.

1. Sluit de gemarkeerde draad van de linkerluidspreker aan op de positieve klem **+ L** en de ongemarkeerde draad op de negatieve klem **L -**.
2. Sluit de gemarkeerde draad van de rechterluidspreker aan op de positieve klem **+ R** en de ongemarkeerde draad op de negatieve klem **R -**.

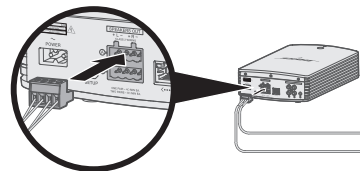
3

Sluit klemblok A opnieuw aan.

Om een tweede paar luidsprekers aan te sluiten, herhaal je stap 1-3 met klemblok B.

Opmerking: Raadpleeg de gebruikershandleiding van je luidspreker voor instructies over het aansluiten van het andere uiteinde van de luidsprekerkabels op de luidsprekers. Je kunt maximaal twee paar omversterkte luidsprekers aansluiten.

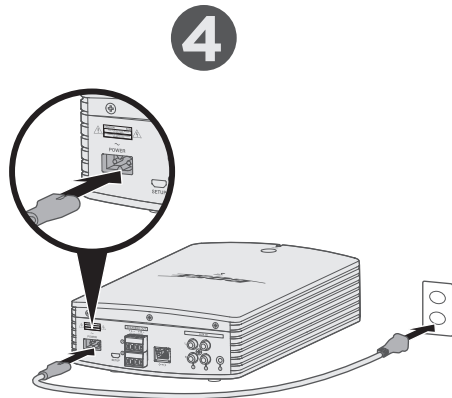

Sluit op het lichtnet aan.

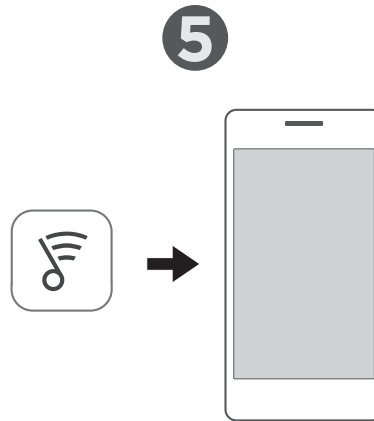

Download de SoundTouch®-app.*

*Als je een computer gebruikt, ga dan naar global.Bose.com/Support/SAS om de app te downloaden.

Heb je vragen? global.Bose.com/Support/SA5

Wandbevestiging

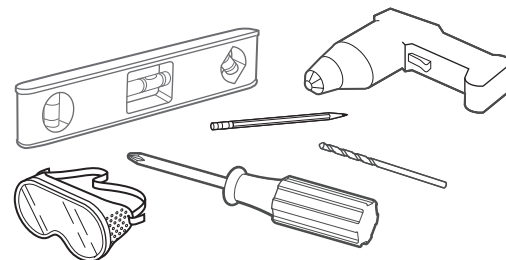
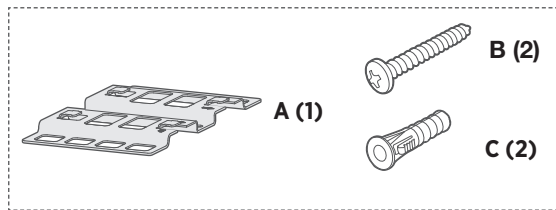

Item	Hout	Gipsplaat
Wanddikte	19 mm of dikker	9,5 mm of dikker
Boortje	2,38 mm	6,35 mm
Houtschroeven, kruiskop (2)	nr. 10 x M5 x 32 mm	nr. 10 x M5 x 32 mm
Plastic muurpluggen (2)	Niet gebruikt	Plastic muurpluggen nr. 10 (M5)

1

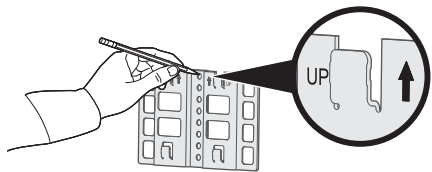

2

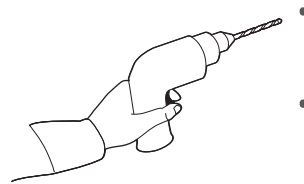

3

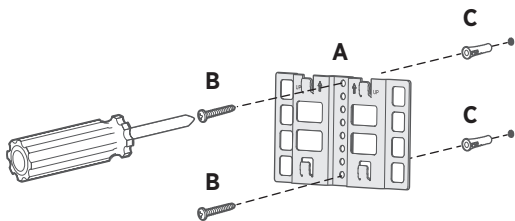

4

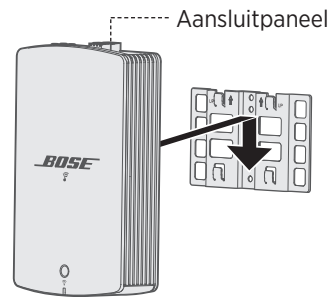

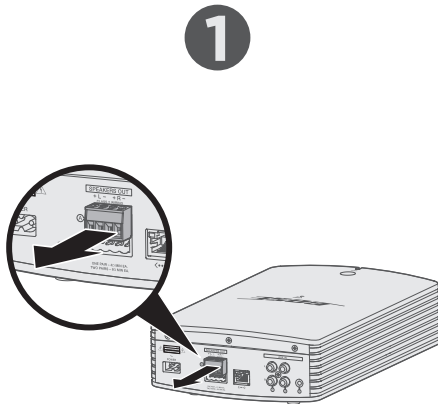

Quitar el bloque terminal A.

Cada bloque terminal acepta un par de altavoces.

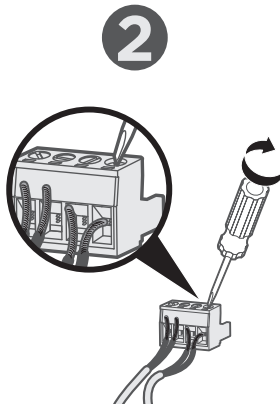

Conectar y asegurar los cables del altavoz al bloque terminal A.

1. Enchufe el cable izquierdo marcado del altavoz en el terminal **+ L** positivo y el cable simple en el terminal **L -** negativo.
2. Enchufe el cable derecho marcado del altavoz en el terminal **+ R** positivo y el cable simple en el terminal **R -** negativo.

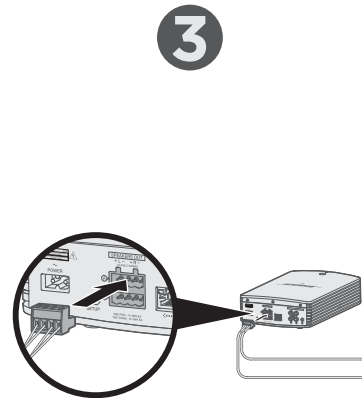

Volver a insertar el bloque terminal A.

Para conectar un segundo par de altavoces, repita los pasos 1-3 usando el bloque terminal B.

Nota: Consulte la guía del usuario del altavoz para obtener instrucciones sobre la conexión del otro extremo de los cables del altavoz a los altavoces. Puede conectar hasta dos pares de altavoces sin alimentación.

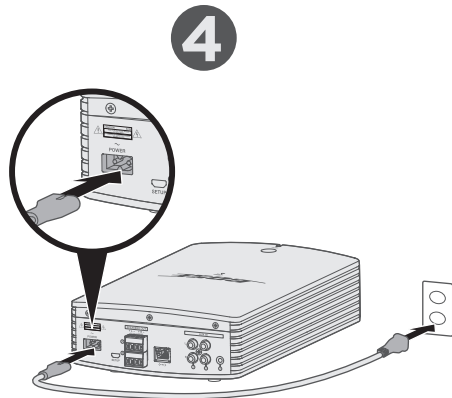

Conectar a la alimentación.

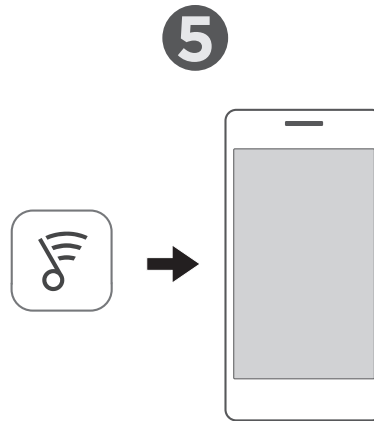

Descargar la aplicación SoundTouch®*

*Si usa una computadora vaya a global.Bose.com/Support/SA5 para descargar la aplicación.

¿Tiene preguntas? global.Bose.com/Support/SA5

Montaje en la pared

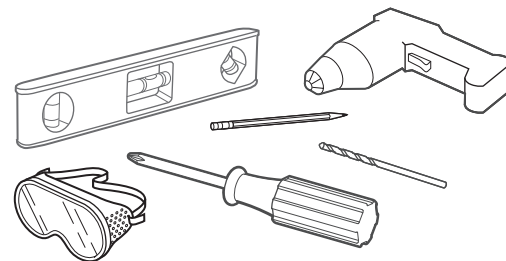
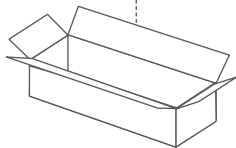
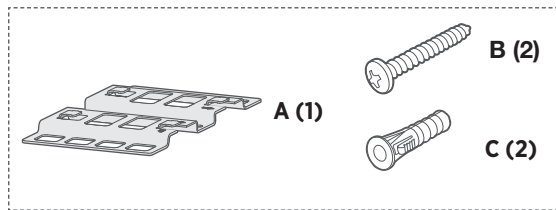

Elemento	Madera	Yeso
Espesor de la pared	¾ pulg. (19 mm) o más grueso	¾ pulg. (9,5 mm) o más grueso
Broca	⅜ pulg. (2,38 mm)	¼ pulg. (6,35 mm)
Tornillos para madera tipo Phillips (2)	N.º 10 x 1 ¼ pulg. (M5 x 32 mm)	N.º 10 x 1 ¼ pulg. (M5 x 32 mm)
Fijadores de plástico (2)	No se utiliza	Fijadores de plástico #10 (M5)

1

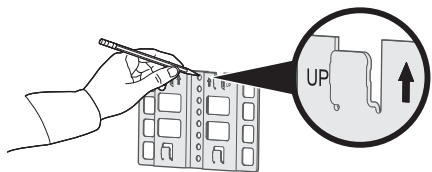

2

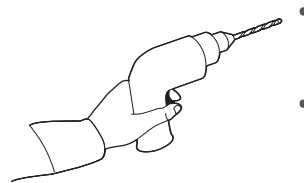

3

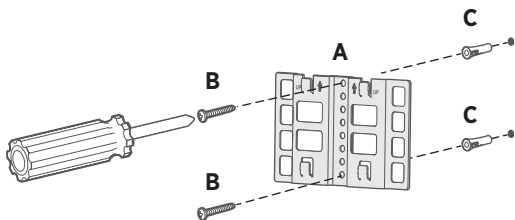

4

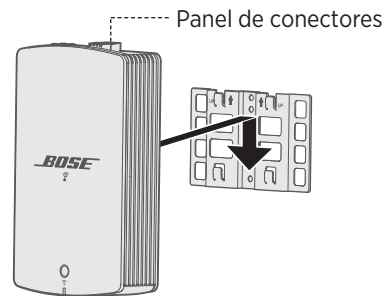

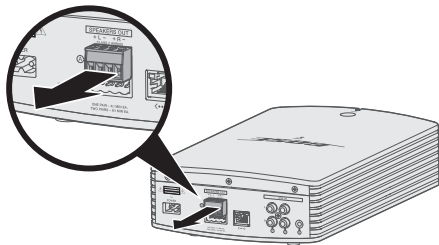
1

Irrota riviliitin A.

Kuhunkin riviliittimeen voidaan liittää yksi kaiutinpari.

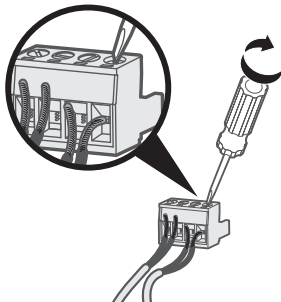
2

Liitä ja kiinnitä kaiutinjohdot riviliittimeen A.

1. Työnnä vasemman kaiuttimen merkitty johdin positiiviseen **+ L** -liitäntään ja merkitsemätön johdin negatiiviseen **L -** -liitäntään.
2. Työnnä oikean kaiuttimen merkitty johdin positiiviseen **+ R** -liitäntään ja merkitsemätön johdin negatiiviseen **R -** -liitäntään.

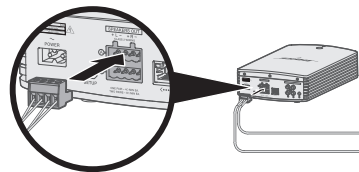
3

Työnnä riviliitin A takaisin paikalleen.

Liitä toinen kaiutinpari toistamalla vaiheet 1–3 käyttäen riviliitintä B.

Huomautus: Ohjeita kaiutinjohtojen toisen pään liittämiseen kaiuttimiin on kaiuttimen käyttöohjeessa. Voit liittää enintään kaksi kaiutinparia, joissa ei ole vahvistinta.

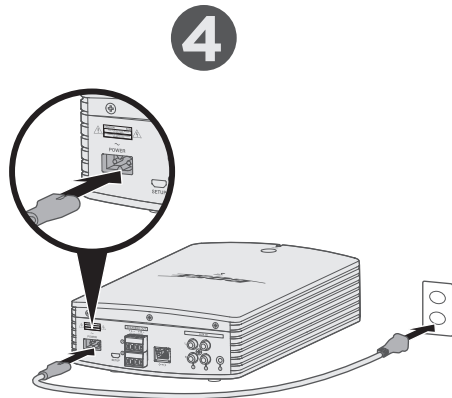

Kytke virta.

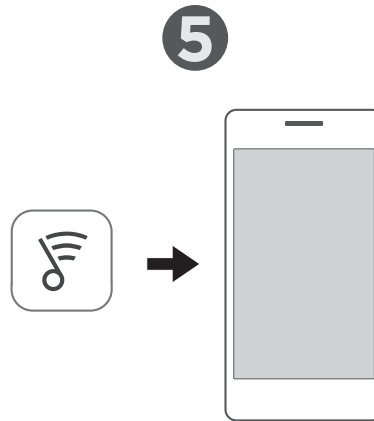

Lataa SoundTouch®-sovellus.*

*Jos käytät tietokonetta, lataa sovellus osoitteesta global.Bose.com/Support/SA5.

Onko sinulla kysyttävää? global.Bose.com/Support/SA5

Kiinnittäminen seinään

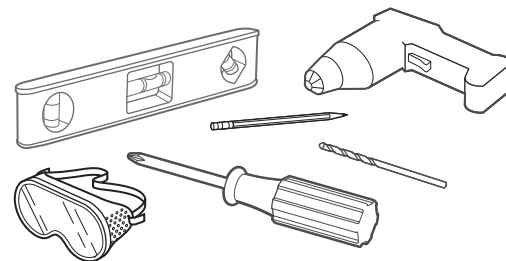
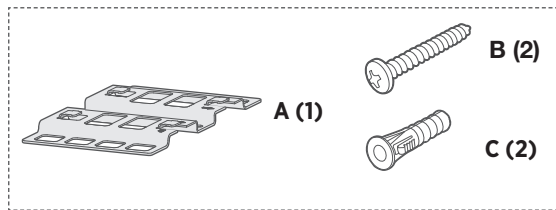

Kohde	Puu	Levyseinä
Seinän paksuus	Vähintään 19 mm	Vähintään 9,5 mm
Poranterä	2,38 mm	6,35 mm
Phillips-puuruuvit (2)	M5 x 32 mm	M5 x 32 mm
Muovitulpat (2)	Ei käytössä	M5-muovitulpat

1

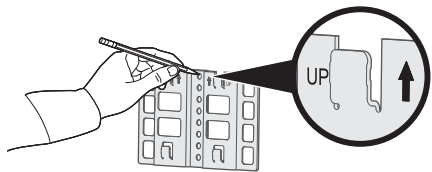

2

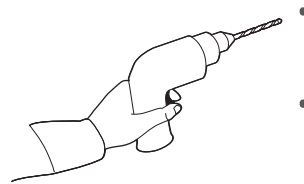

3

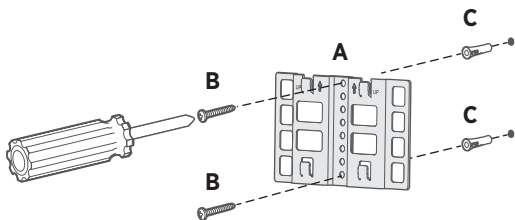

4

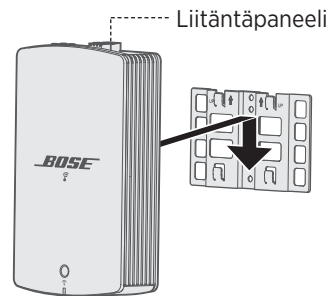

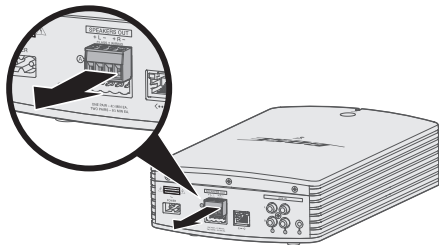
1

Retirez la borne A.

Chaque borne peut recevoir une paire d'enceintes.

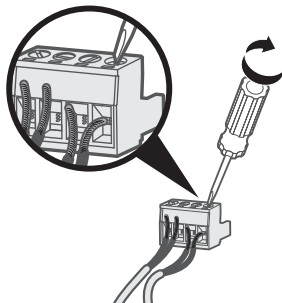
2

Raccordez correctement les câbles d'enceinte à la borne A.

1. Insérez le câble marqué de l'enceinte gauche à la borne positive **+ L** et le câble uni à la borne négative **L -**.
2. Insérez le câble marqué de l'enceinte gauche à la borne positive **+ R** et le câble uni à la borne négative **R -**.

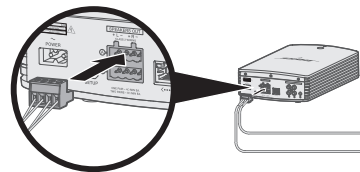
3

Remettez la borne A en place.

Pour raccorder une deuxième paire d'enceintes, répétez les étapes 1 à 3 en utilisant la borne B.

Remarque : reportez-vous à la notice d'utilisation des enceintes pour savoir comment raccorder l'autre extrémité des câbles d'enceinte aux enceintes. Vous pouvez raccorder jusqu'à deux paires d'enceintes non amplifiées.

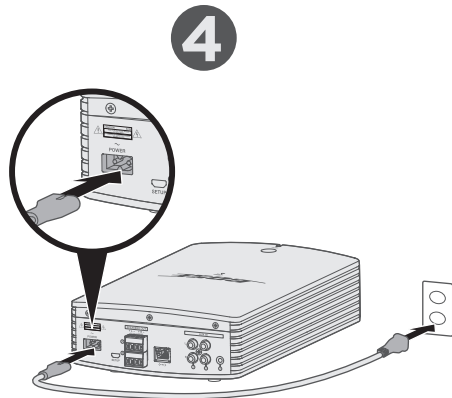

**Raccordez l'amplificateur
à la prise secteur.**

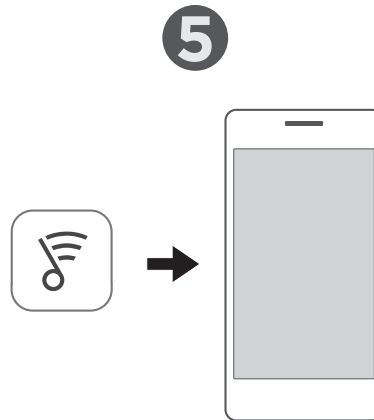

Téléchargement de l'application SoundTouch®

*Si vous utilisez un ordinateur, accédez à la page
global.Bose.com/Support/SA5 pour télécharger l'application.

Des questions ? global.Bose.com/Support/SA5

Montage mural

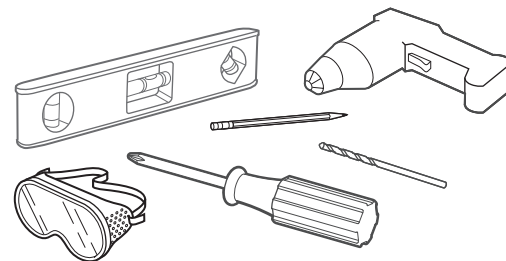
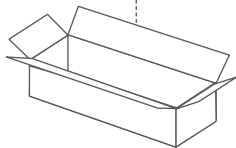
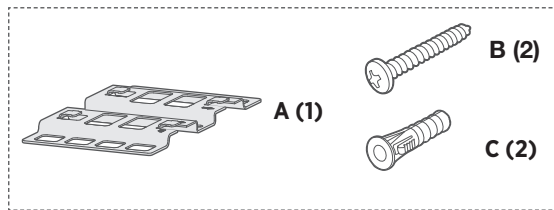

Élément	Bois	Cloison en plâtre
Épaisseur du mur	19 mm ou plus	9,5 mm ou plus
Mèche	2,38 mm	6,35 mm
Vis à bois Phillips (2)	#10 x M5 x 32 mm	#10 x M5 x 32 mm
Chevilles en plastique (2)	Non utilisées	#10 chevilles en plastique (M5)

1

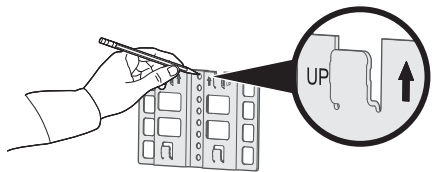

2

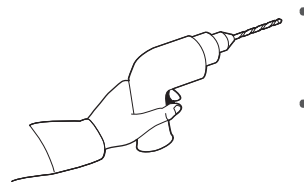

3

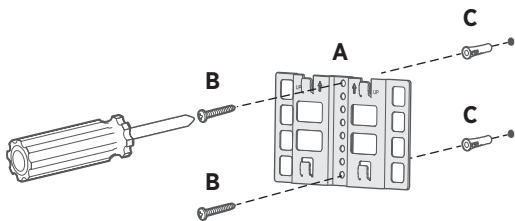

4

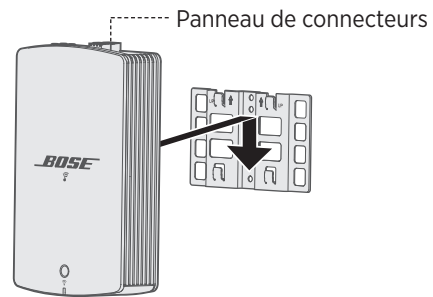

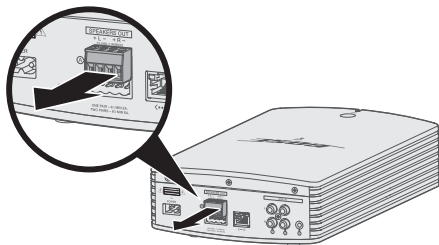
1

Rimuovere la morsettiere A.

Ogni morsettiere accetta una coppia di diffusori.

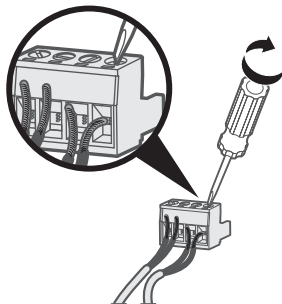
2

Collegare e fissare i fili dei diffusori alla morsettiere A.

1. Inserire il filo contrassegnato del diffusore sinistro nel terminale positivo **+ L** e il filo non contrassegnato nel terminale negativo **L -**.
2. Inserire il filo contrassegnato del diffusore destro nel terminale positivo **+ R** e il filo non contrassegnato nel terminale negativo **R -**.

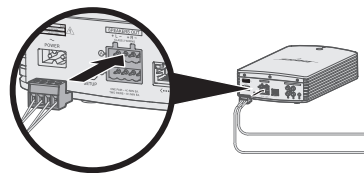
3

Reinserire la morsettiere A.

Per collegare una seconda coppia di diffusori, ripetere i passaggi da 1 a 3 utilizzando la morsettiere B.

Nota: consultare il manuale di istruzioni del diffusore per le istruzioni su come collegare l'altra estremità dei fili ai diffusori. È possibile collegare fino a due coppie di diffusori non alimentati.

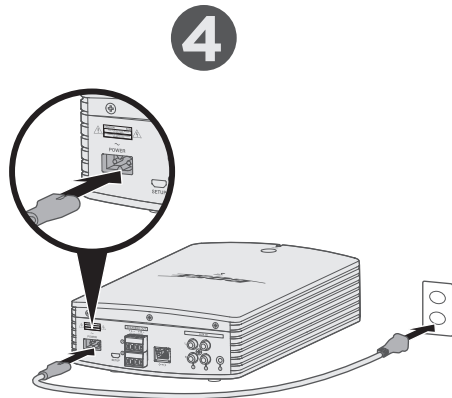

Collegare all'alimentazione.

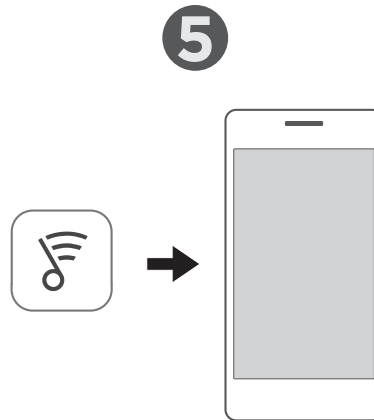

Scaricare l'app SoundTouch®*.

*Se si usa un computer, andare all'indirizzo global.Bose.com/Support/SA5 per scaricare l'app.

Domande? global.Bose.com/Support/SA5

ITALIANO

Montaggio a parete

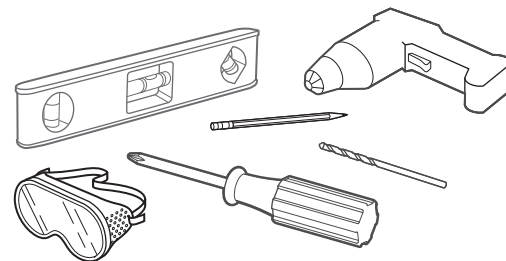
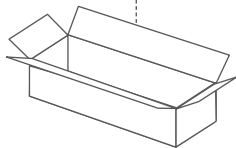
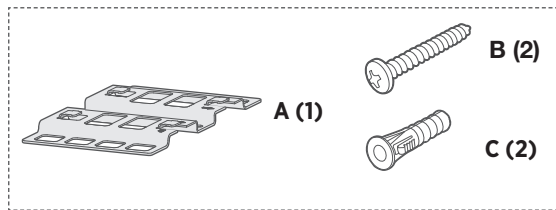

Elemento	Legno	Pannello in cartongesso
Spessore parete	Almeno 19 mm	Almeno 9,5 mm
Tipo di punta da trapano	2,38 mm	6,35 mm
Viti da legno con testa a croce (2)	10 x M5 x 32 mm	10 x M5 x 32 mm
Tasselli in plastica (2)	Non utilizzato	10 tasselli in plastica M5

1

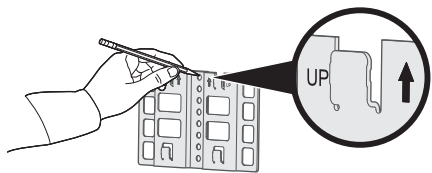

2

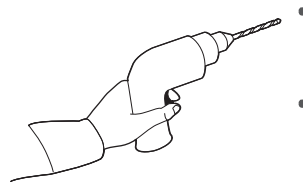

3

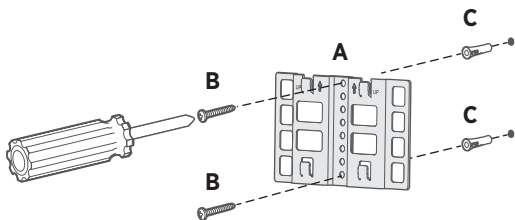

4

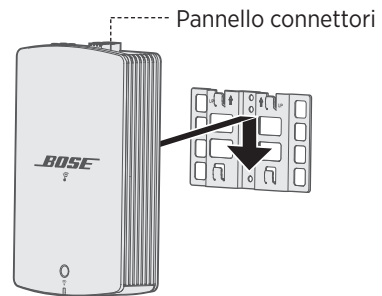

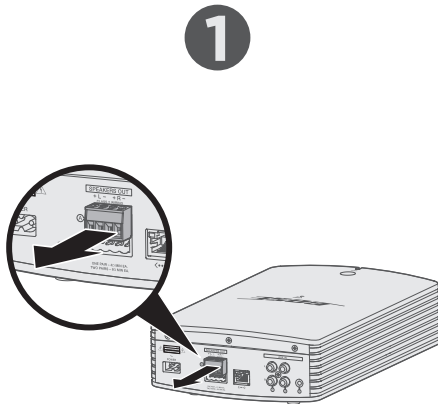

Távolítsa el az „A” sorkapcsot.

Az egyes sorkapcsokba egy pár hangszóró csatlakoztatható.

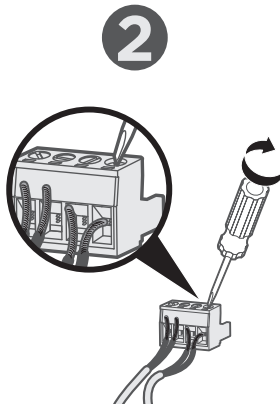

Csatlakoztassa és rögzítse a hangszóróvezetéseket az „A” sorkapcsba.

1. A bal oldali hangszóró megjelölt vezetékét dugja a **+ L** pozitív terminálba, a sima vezetékét pedig a **L –** negatív terminálba.
2. A jobb oldali hangszóró megjelölt vezetékét dugja a **+ R** pozitív terminálba, a sima vezetékét pedig az **R –** negatív terminálba.

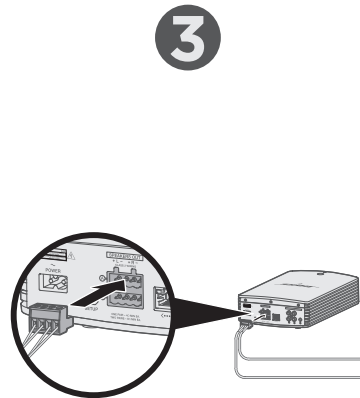

Dugja vissza az „A” sorkapcsot.

Egy második hangszórópár csatlakoztatásához ismétlje meg az 1–3. lépéseket a „B” sorkapocs használatával.

Megjegyzés: A hangszóróvezetékek másik végének hangszóróhoz csatlakoztatásával kapcsolatos tudnivalókat a hangszóró kezelési útmutatójában találja. Legfeljebb két pár passzív hangszórót csatlakoztathat.

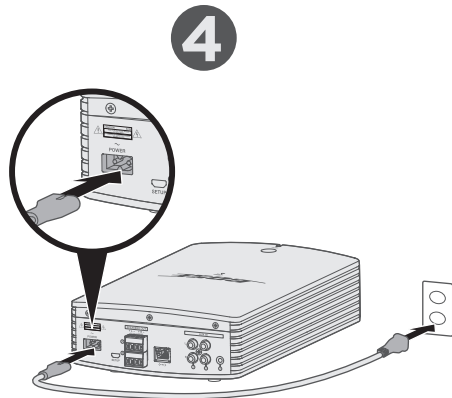

Csatlakoztassa az áramforráshoz.

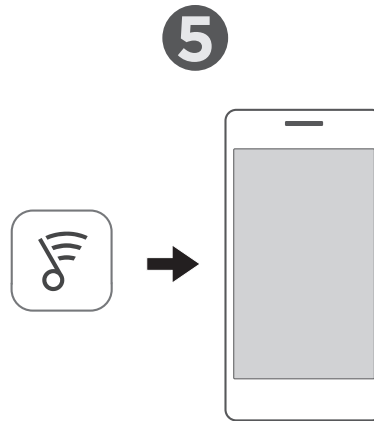

A SoundTouch® alkalmazás letöltése.*

*Ha számítógépet használ, a global.Bose.com/Support/SA5 weboldaltól töltheti le az alkalmazást

Kérdései vannak? global.Bose.com/Support/SA5

Falra szerelés

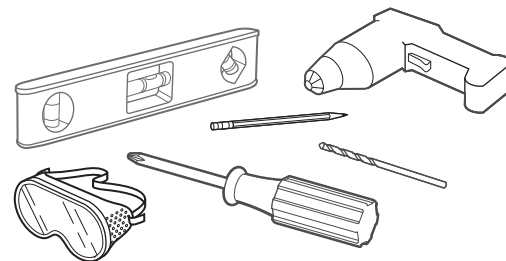
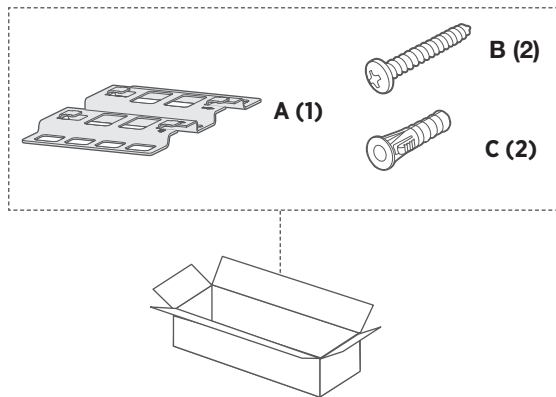

Tétel	Fa	Gipszkarton
Falvastagság	19 mm vagy vastagabb	9,5 mm vagy vastagabb
Fúrófej	2,38 mm	6,35 mm
Csillagfejű facsavarok (2)	#10 x ¼" (M5 x 32 mm)	#10 x ¼" (M5 x 32 mm)
Műanyag dübelek (2)	Nem szükséges	10-es sz. (M5) műanyag dübelek

1

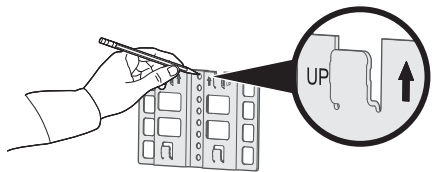

2

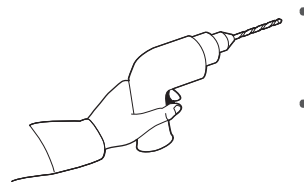

3

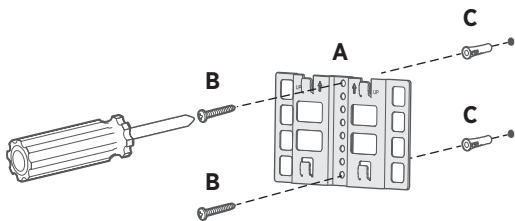

4

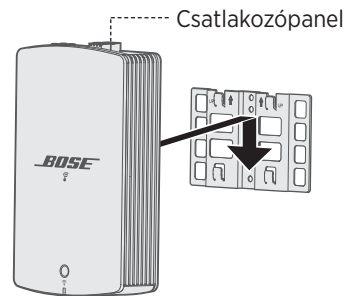

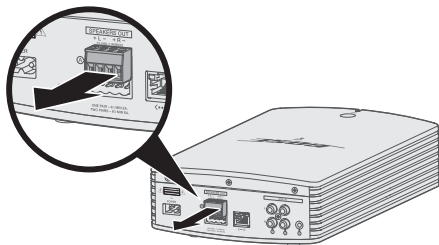
1

Fjern terminalkontakt A.

Hver terminalkontakt lar deg koble til ett høyttalerpar.

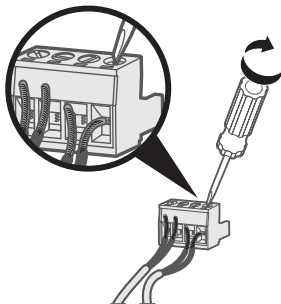
2

Koble til og feste høyttalerledningen til terminalkontakt A.

1. Sett den merkede venstre høyttalerledningen inn i den positive terminalen (**+ L**) og den umerkede ledningen i den negative terminalen (**L -**).
2. Sett den merkede høyre høyttalerledningen inn i den positive terminalen (**+ R**) og den umerkede ledningen i den negative terminalen (**R -**).

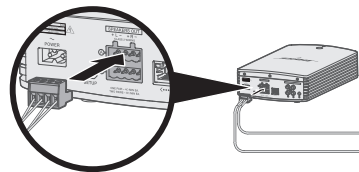
3

Sett i terminalkontakt A på nytt.

Hvis du vil koble til enda et høyttalerpar, gjentar du trinn 1-3 for terminalkontakt B.

Merk: Se brukerhåndboken for høyttaleren for informasjon om hvordan du kobler den andre enden av høyttalerledningene til høyttalerne. Du kan koble til opptil to høyttalerpar som ikke drives av strøm.

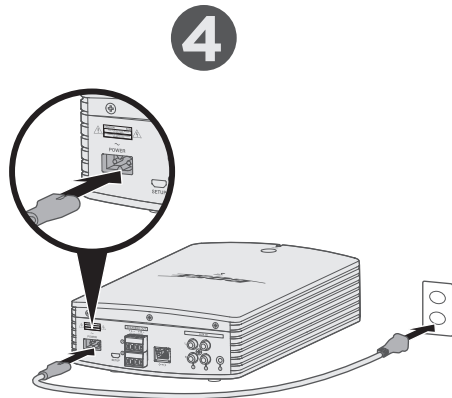

Koble til strøm.

5



Laste ned SoundTouch®-appen.*

*Hvis du bruker en datamaskin, kan du gå til global.Bose.com/Support/SA5 for å laste ned appen.

Har du spørsmål? global.Bose.com/Support/SA5

Veggmontering

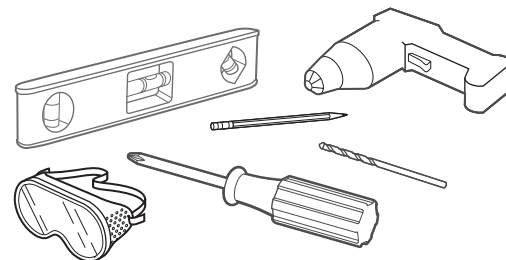
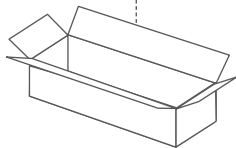
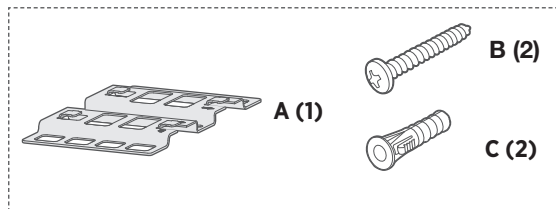

Vare	Tre	Veggplate
Veggykkelse	19 mm ($\frac{3}{4}$ tommer) eller tykkere	9,5 mm ($\frac{3}{8}$ tommer) eller tykkere
Bor	2,38 mm ($\frac{3}{32}$ tommer)	6,35 mm ($\frac{1}{4}$ tommer)
Treskruer med Phillips-hode (2)	M5 x 32 mm (#10 x $1\frac{1}{4}$ tommer)	M5 x 32 mm (#10 x $1\frac{1}{4}$ tommer)
Plastveggankre (2)	Ikke i bruk	M5 (#10) plastaveggankre

1

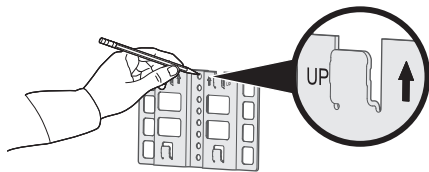

2

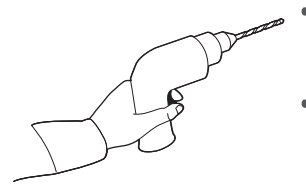

3

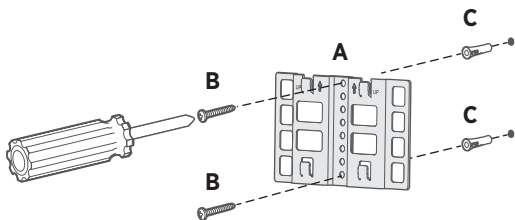

4

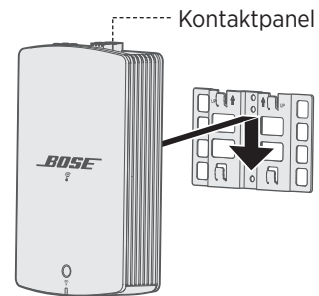

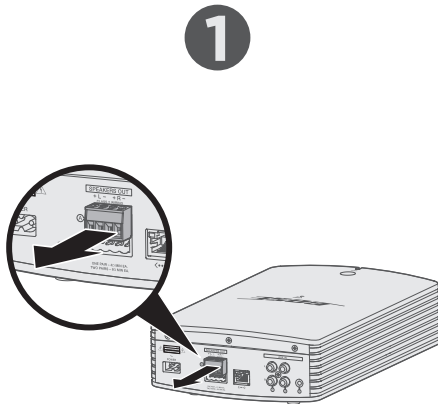

Wyjmij blok zacisków A.

Do każdego bloku zacisków można podłączyć jedną parę głośników.

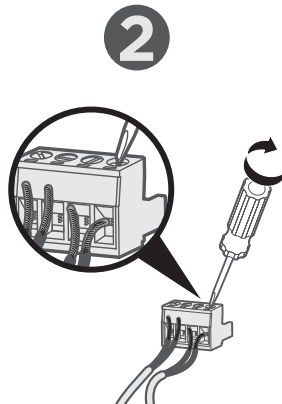

Podłącz przewody głośnikowe do bloku zacisków A i zamocuj je.

1. Wsuń oznaczony przewód lewego głośnika do dodatniego zacisku **+ L**, a zwykły przewód do ujemnego zacisku **L -**.
2. Wsuń oznaczony przewód prawego głośnika do dodatniego zacisku **+ R**, a zwykły przewód do ujemnego zacisku **R -**.

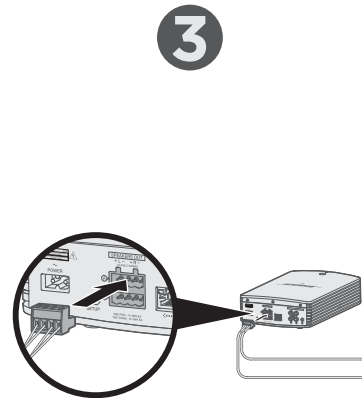

Włóż z powrotem blok zacisków A.

Aby podłączyć drugą parę głośników, powtórz kroki 1-3 przy użyciu bloku zacisków B.

Uwaga: Instrukcje dotyczące podłączania drugiego końca przewodów głośnikowych do głośników podano w podręczniku użytkownika głośnika. Można podłączyć maksymalnie dwie pary głośników niezasilanych.

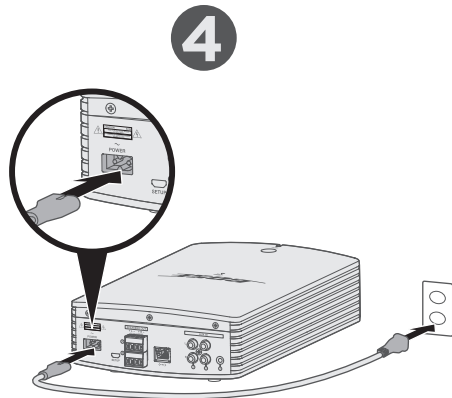

Podłącz zasilanie.

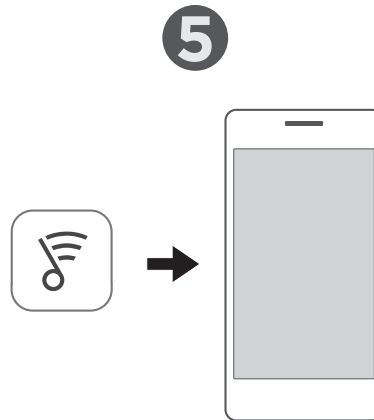

Pobierz aplikację SoundTouch®*.

*Użytkownicy komputerów powinni przejść do witryny global.Bose.com/Support/SA5 w celu pobrania aplikacji.

Masz pytania? global.Bose.com/Support/SA5

Montaż na ścianie

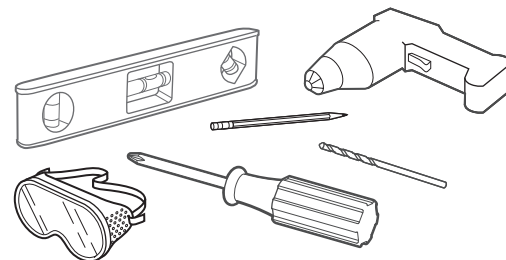
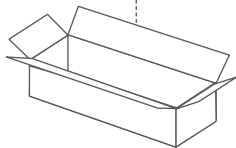
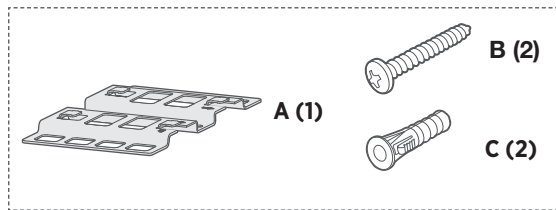

Pozycja	Drewno	Płyta ścienna
Grubość ściany	19 mm lub grubsza	9,5 mm lub grubsza
Wiertło	2,38 mm	6,35 mm
Wkręty z łbem z gniazdem krzyżowym (2)	M5 x 32 mm	M5 x 32 mm
Plastikowe kołki rozporowe (2)	Nie używane	Plastikowe kołki rozporowe M5

1

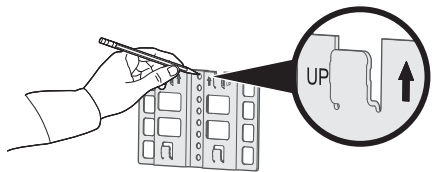

2

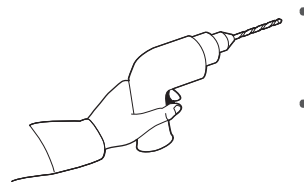

3

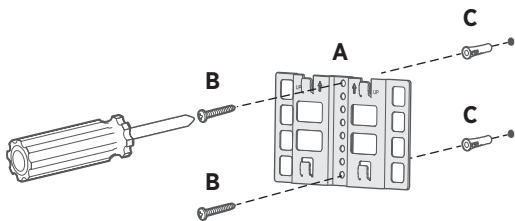

4

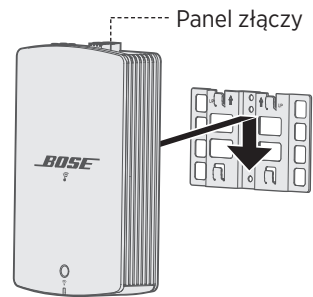

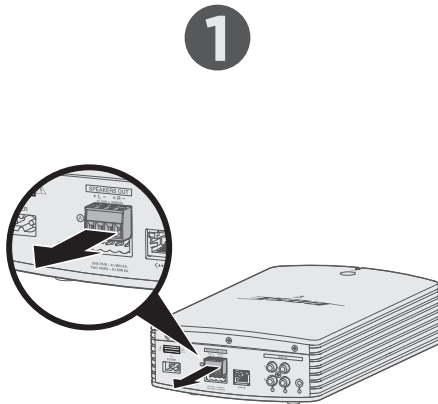

Remova o bloco de terminais A.

Cada bloco de terminais aceita um par de alto-falantes.

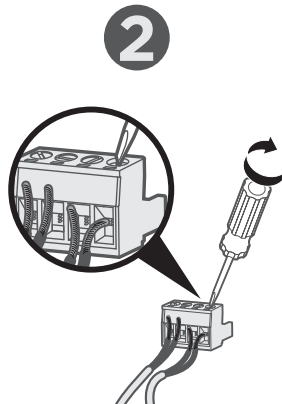

Conecte e fixe os fios dos alto-falantes ao bloco de terminais A.

1. Insira o fio marcado do alto-falante esquerdo no terminal positivo **+ L** e o fio liso no terminal negativo **L -**.
2. Insira o fio marcado do alto-falante direito no terminal positivo **+ R** e o fio liso no terminal negativo **R -**.

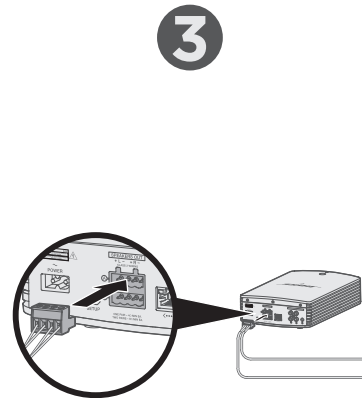

Reinsira o bloco de terminais A.

Para conectar um segundo par de alto-falantes, repita as etapas de 1 a 3 usando o bloco de terminais B.

Observação: Consulte o manual do proprietário do alto-falante para obter instruções sobre como conectar a outra extremidade dos fios aos alto-falantes. Você pode conectar até dois pares de alto-falantes sem amplificação.

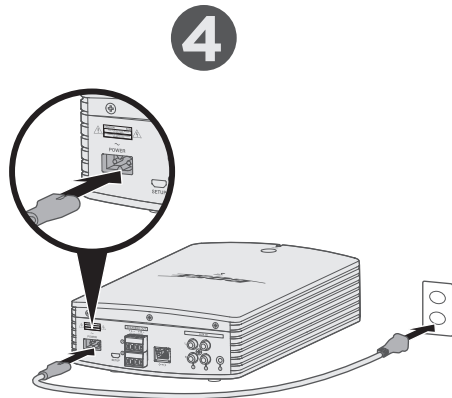

Conecte à energia.

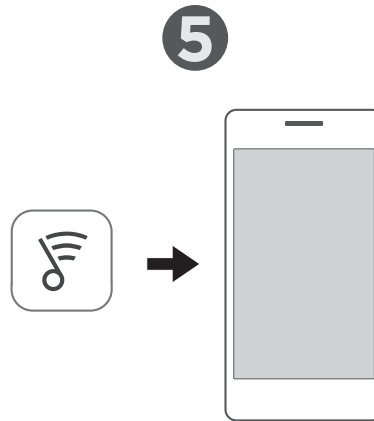

Baixe o aplicativo SoundTouch®.*

*Se estiver usando um computador, acesse global.Bose.com/Support/SA5 para baixar o aplicativo.

Alguma dúvida? global.Bose.com/Support/SA5

Montagem na parede

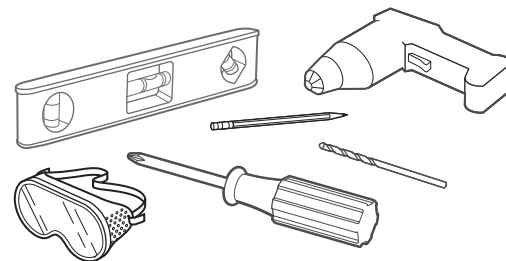
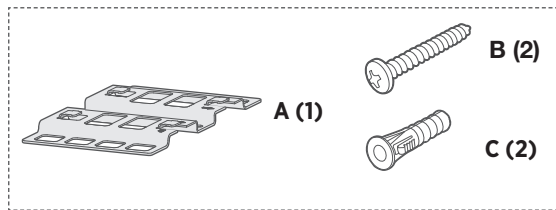

Item	Madeira	Gesso
Espessura da parede	19 mm ou mais espessa	9,5 mm ou mais espessa
Broca	2,38 mm	6,35 mm
Parafusos de madeira de cabeça Phillips (2)	#10 M5 x 32 mm	#10 M5 x 32 mm
Buchas de plástico (2)	Não usadas	#10 buchas de plástico (M5)

1

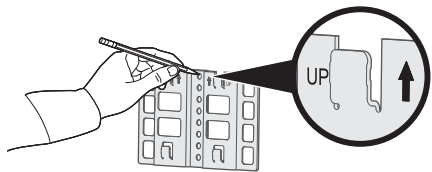

2

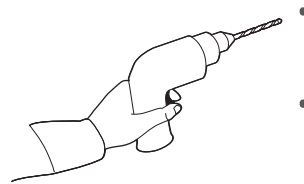

3

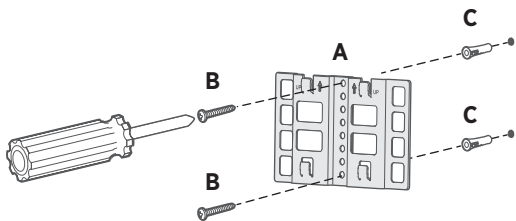

4

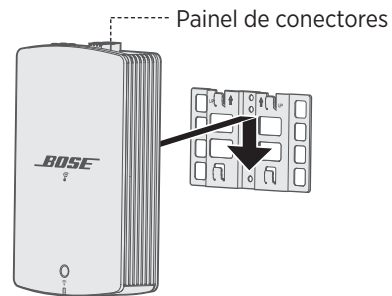

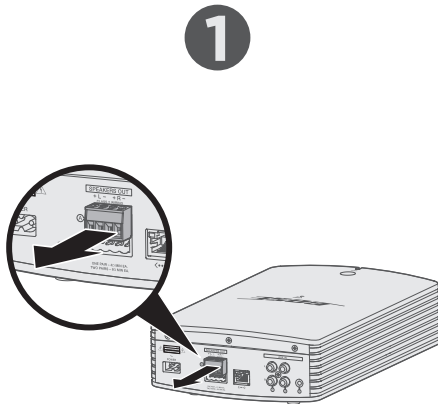

Ta bort anslutningsplinten A.

Varje anslutningsplint är avsedd för ett högtalarpar.

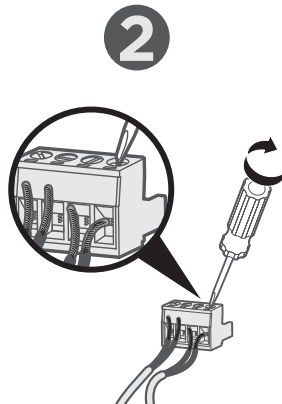

Anslut och sätt fast högtalarledningarna i anslutningsplinten A.

1. För in den vänstra högtalarens markerade ledning i den positiva **+ L** -kontakten och den andra ledningen i den negativa **L -** -kontakten.
2. För in den högra högtalarens markerade ledning i den positiva **+ R** -kontakten och den andra ledningen i den negativa **R -** -kontakten.

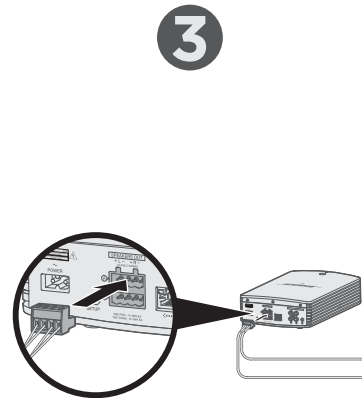

Sätt tillbaka anslutningsplinten A.

Upprepa steg 1 till 3 med anslutningsplint B för att ansluta nästa högtalarpar.

Obs! I bruksanvisningen beskrivs hur du ansluter den andra änden av högtalarledningarna i högtalarna. Du kan ansluta upp till två par passiva högtalare.

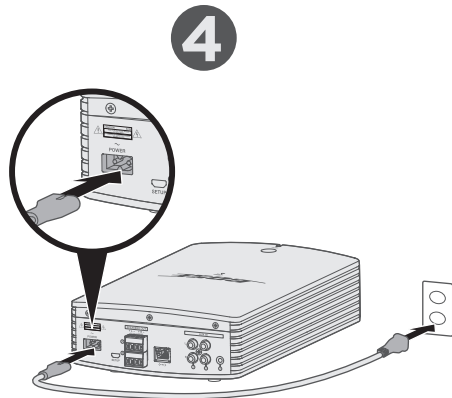

Anslut till en strömkälla.

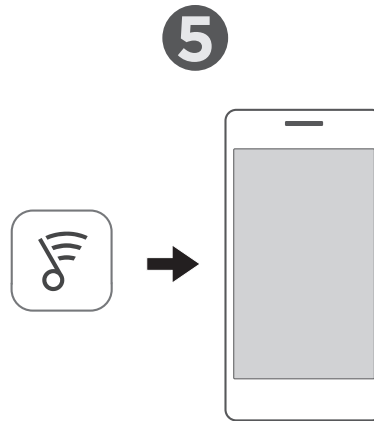

Ladda ned SoundTouch™-appen.*

*Om du använder en dator går du till global.Bose.com/Support/SA5 för att ladda ned appen.

Har du några frågor? global.Bose.com/Support/SA5

Väggmontering

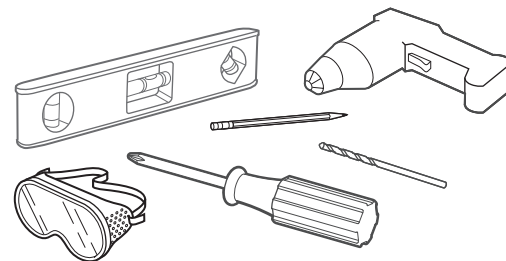
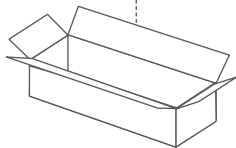
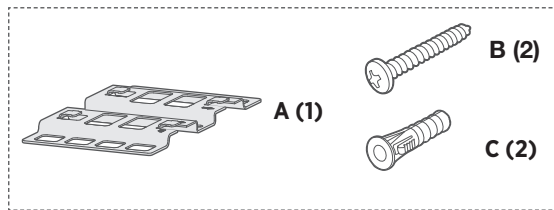

Ämne	Trä	Väggplatta
Väggens tjocklek	19 mm eller tjockare	9,5 mm eller tjockare
Borr	2,38 mm	6,35 mm
Phillips-tråskruv (2)	M5 x 32 mm	M5 x 32 mm
Plugg (2)	Används ej	M5-plugg

1

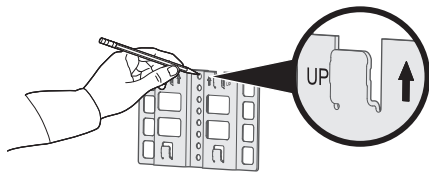

2

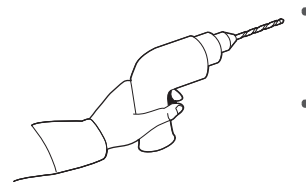

3

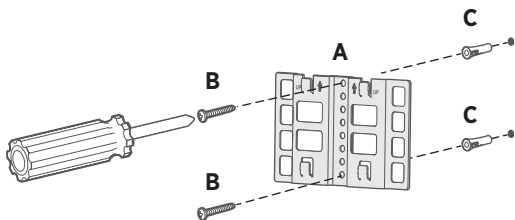

4

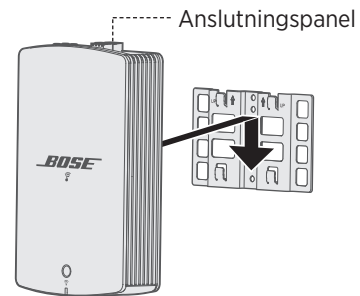

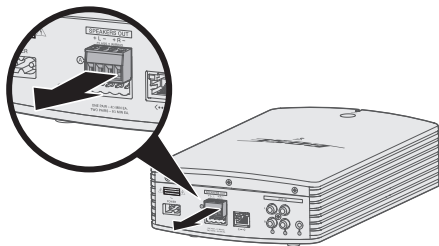
1

ถอดแผงขั้วต่อ A ออก

แต่ละแผงขั้วต่อยอมรับลำโพงหนึ่งคู่

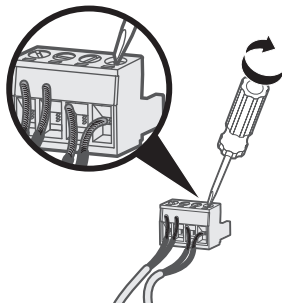
2

เชื่อมต่อและยึดสายลำโพงกับแผงขั้วต่อ A

1. เสียบสายไฟที่ทำเครื่องหมายไว้ของลำโพงซ้ายเข้ากับขั้วต่อขั้วบวก **+ L** และสายธรรมดาเข้ากับขั้วต่อขั้วลบ **L -**
2. เสียบสายไฟที่ทำเครื่องหมายไว้ของลำโพงขวาเข้ากับขั้วต่อขั้วบวก **+ R** และสายธรรมดาเข้ากับขั้วต่อขั้วลบ **R -**

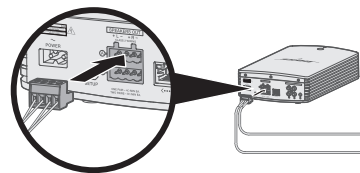
3

เสียบแผงขั้วต่อ A อีกครั้ง

หากต้องการเชื่อมต่อลำโพงคู่ที่สอง ทำซ้ำขั้นตอนที่ 1-3 โดยใช้แผงขั้วต่อ B

หมายเหตุ: โปรดดูคู่มือผู้ใช้ลำโพงสำหรับคำแนะนำเกี่ยวกับการเชื่อมต่อปลายสายลำโพงอีกด้านกับลำโพง คุณสามารถเชื่อมต่อลำโพงที่ไม่มีกำลังขับได้ถึงสองคู่

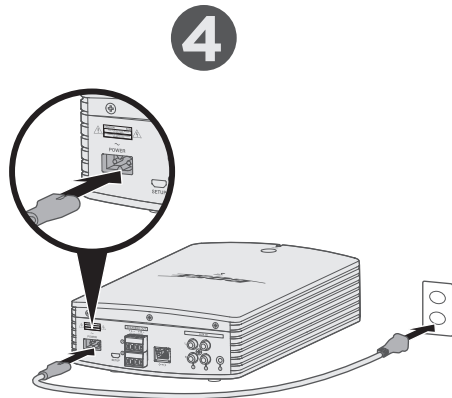

เชื่อมต่อกับแหล่งจ่ายไฟ

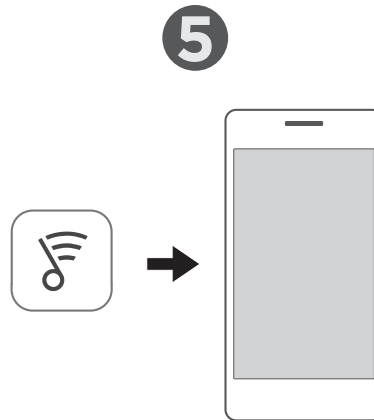

ดาวน์โหลด แอปพลิเคชัน **SoundTouch®***

*หากใช้คอมพิวเตอร์ไปที่ global.Bose.com/Support/SA5
เพื่อดาวน์โหลดแอปพลิเคชัน

มีคำถาม? global.Bose.com/Support/SA5

การติดตั้งบนผนัง

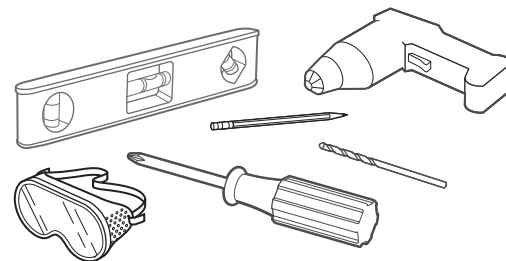
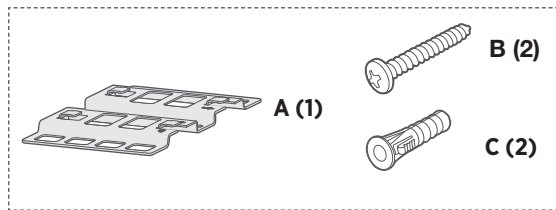

รายการ	ไม้	แผ่นบอร์ดปิดผนัง
ความหนาของผนัง	3/4 นิ้ว (19 มม.) หรือหนากว่า	3/8 นิ้ว (9.5 มม.) หรือหนากว่า
เจาะรู	3/32 นิ้ว (2.38 มม.)	1/4 นิ้ว (6.35 มม.)
สกรูยึดไม้ Phillips (2)	#10 x 1 1/4 นิ้ว (M5 x 32 มม.)	#10 x 1 1/4 นิ้ว (M5 x 32 มม.)
พุกพลาสติก (2)	ไม่มีการใช้	พุกพลาสติก #10 (M5)

1

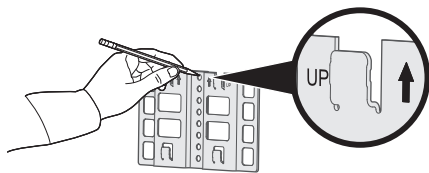

2

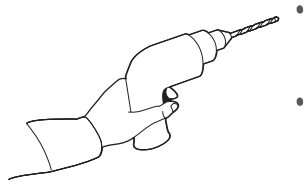

3

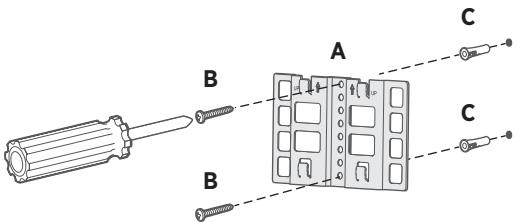

4

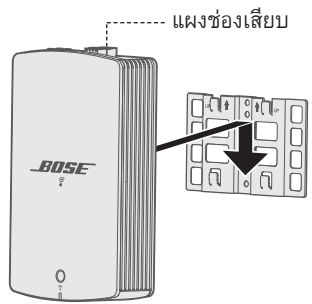

1

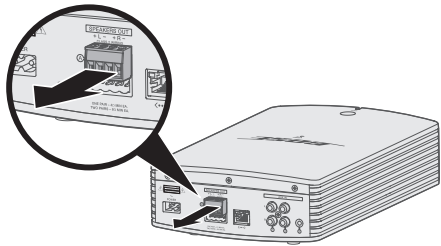

단자 블록 A를 제거합니다.

각 단자 블록에는 스피커 한 쌍이 연결됩니다.

2

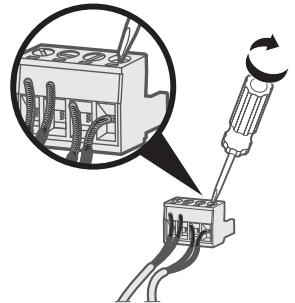

스피커 와이어를 단자 블록 A에 연결하고 고정합니다.

1. 왼쪽 스피커의 표시된 와이어를 **+ L** 양극 단자에, 표시 없는 와이어를 **L -** 음극 단자에 각각 삽입합니다.
2. 오른쪽 스피커의 표시된 와이어를 **+ R** 양극 단자에, 표시 없는 와이어를 **R -** 음극 단자에 각각 삽입합니다.

3

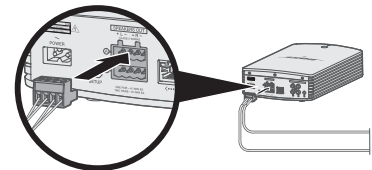

단자 블록 A를 다시 삽입합니다.

스피커의 두 번째 쌍을 연결하려면 단자 블록 B를 사용하여 단계 1-3을 반복합니다.

참고: 스피커 와이어 반대편을 스피커에 연결하는 방법은 스피커 사용자 안내서의 지침을 참조하십시오. 패시브 스피커 최대 두 쌍을 연결할 수 있습니다.

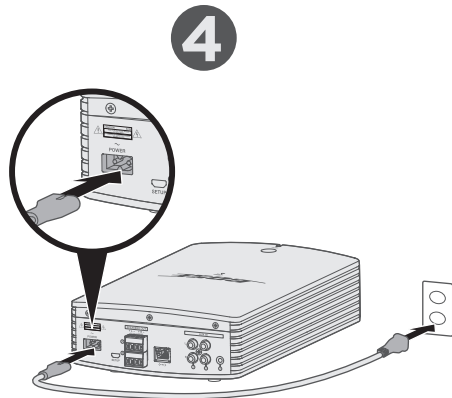

전원을 연결합니다.

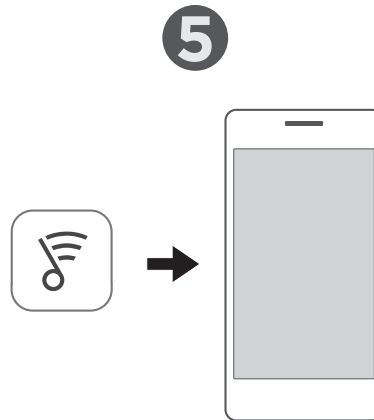

SoundTouch® 앱*을 다운로드합니다.

*컴퓨터를 사용할 경우 global.Bose.com/Support/SA5에서 앱을 다운로드합니다.

질문이 있으신가요? global.Bose.com/Support/SA5

월 마운팅

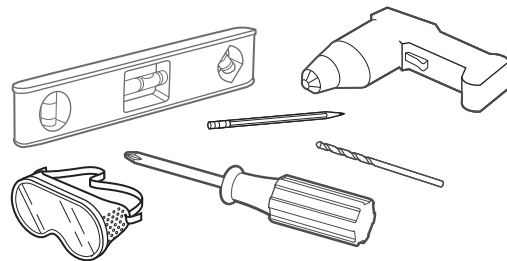
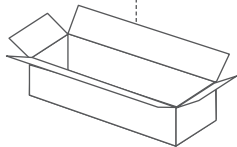
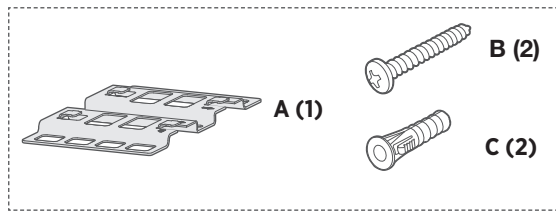

품목	나무	석고보드
벽 두께	19mm 이상	9.5mm 이상
드릴 비트	2.38mm	6.35mm
십자 머리 목재용 나사(2)	#10 x M5 x 32mm	#10 x M5 x 32mm
플라스틱 앵커(2)	사용되지 않음	#10(M5) 플라스틱 앵커

1

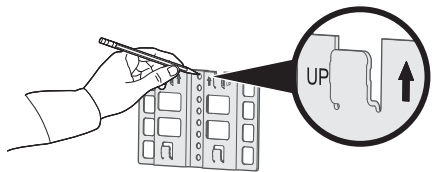

2

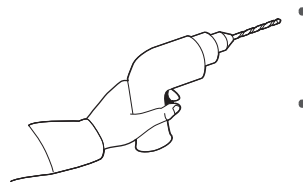

3

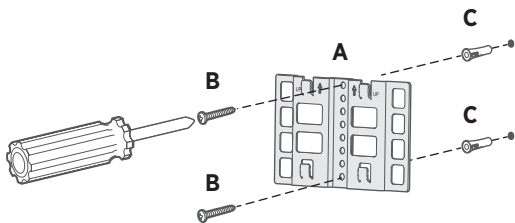

4



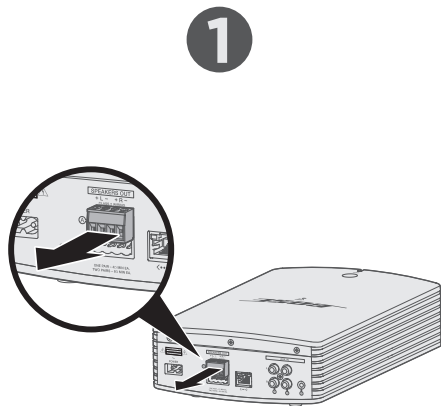

移除接线端子 A。

每个接线端子可插入一对扬声器。

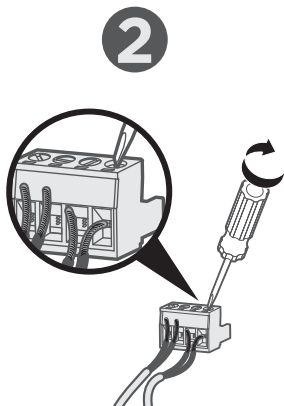

将扬声器线连接到接线端子 A 并固定。

1. 将左扬声器有标记的线插入 **+L** 正极端子，无标记线插入 **L-** 负极端子。
2. 将右扬声器有标记的线插入 **+R** 正极端子，无标记线插入 **R-** 负极端子。

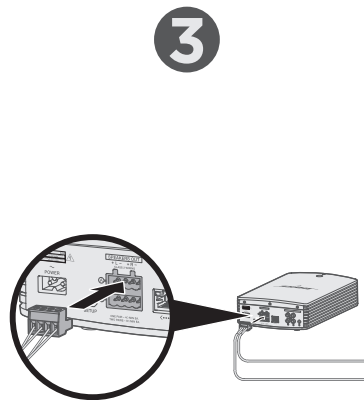

重新插入接线端子 A。

要连接第二对扬声器，请使用接线端子 B 并重复步骤 1-3。

注意：有关将扬声器线的另一端连接至扬声器的说明，请参阅扬声器用户指南。最多可以连接两对未通电扬声器。

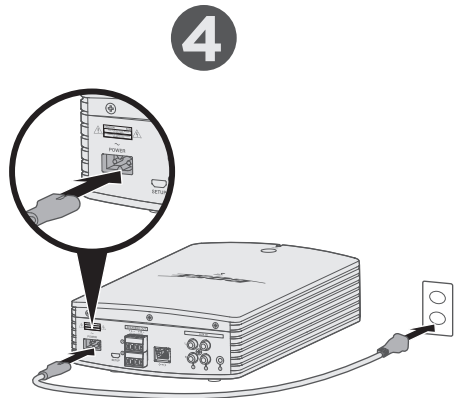

连接电源。

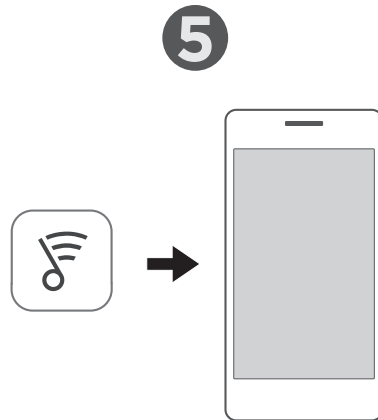

下载 SoundTouch™ 应用程序。*

*若使用电脑，请访问 global.Bose.com/Support/SA5 下载该应用程序。

是否有问题？ global.Bose.com/Support/SA5

壁挂安装

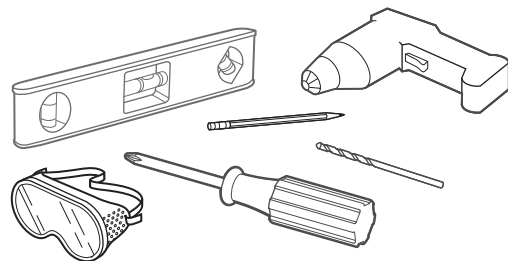
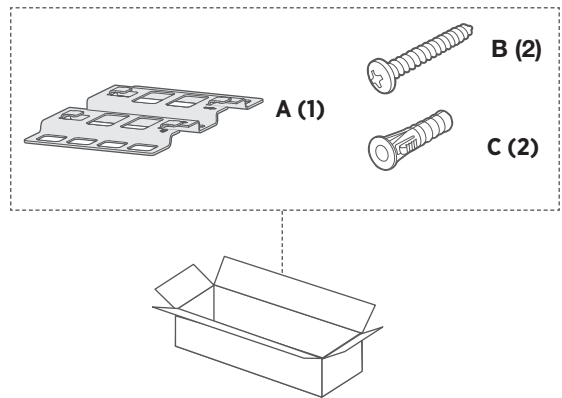

物品	木材	墙板
墙的厚度	19 mm 或更厚	9.5 mm 或更厚
钻头	2.38 mm	6.35 mm
十字木螺丝 (2)	#10 (M5) x 32 mm	#10 (M5) x 32 mm
塑料锚钉 (2)	未使用	#10 (M5) 塑料锚钉

1

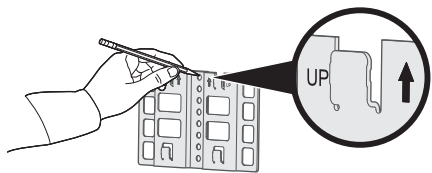

2

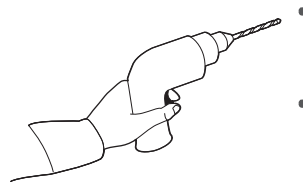

3

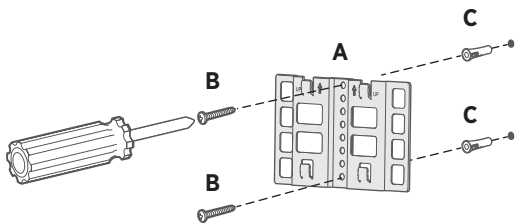

4

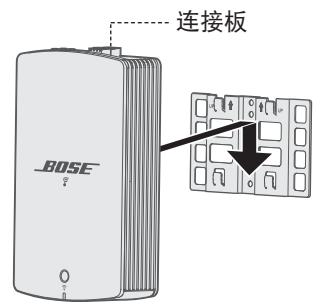

1

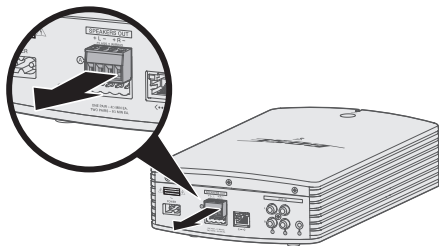

移除接線端子 A。

每個接線端子可插入一對揚聲器。

2

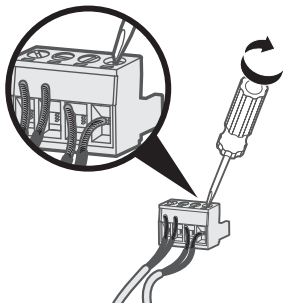

將揚聲器線連接至接線端子 A 並固定。

1. 將左揚聲器有標記的線插入 **+L** 正極端子，無標記線插入 **L-** 負極端子。
2. 將右揚聲器有標記的線插入 **+R** 正極端子，無標記線插入 **R-** 負極端子。

3

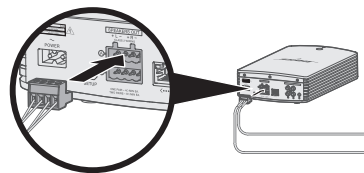

重新插入接線端子 A。

要連接第二對揚聲器，請使用接線端子 B 並重複步驟 1-3。

注意：有關將揚聲器線的另一端連接至揚聲器的指示，請參見揚聲器使用者指南。最多可以連接兩對未通電揚聲器。

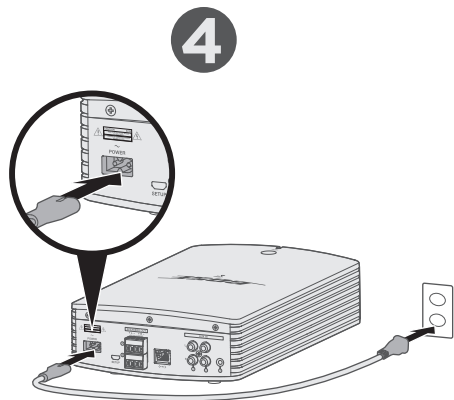

連接至電源。

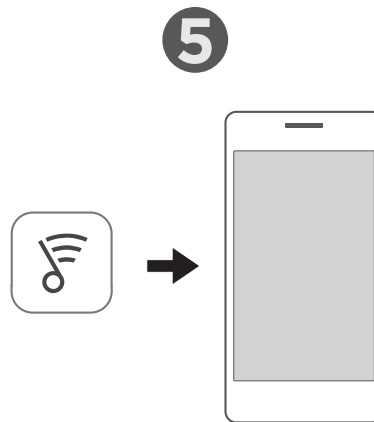

下載 SoundTouch™ 應用程式。*

*若使用電腦，請移至 global.Bose.com/Support/SA5 下載該應用程式。

是否有問題？ global.Bose.com/Support/SA5

壁掛式安裝

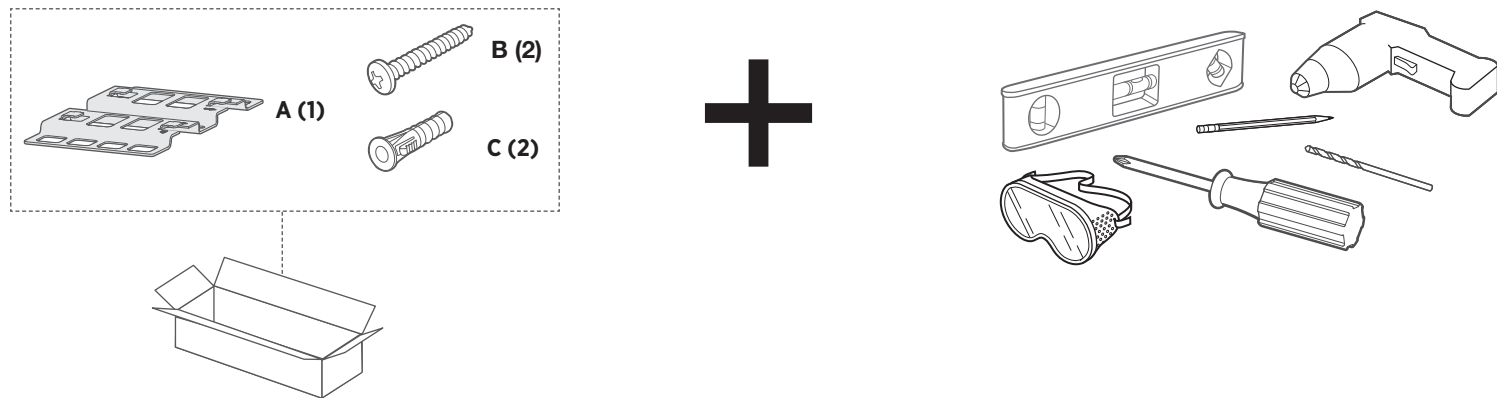

物品	木材	牆板
牆的厚度	19 mm 或更厚	9.5 mm 或更厚
鑽頭	2.38 mm	6.35 mm
十字木螺絲 (2)	#10 (M5) x 32 mm	#10 (M5) x 32 mm
塑膠錨釘 (2)	未使用	#10 (M5) 塑膠錨釘

1

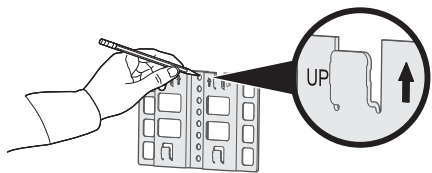

2

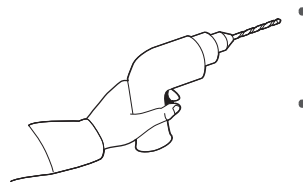

3

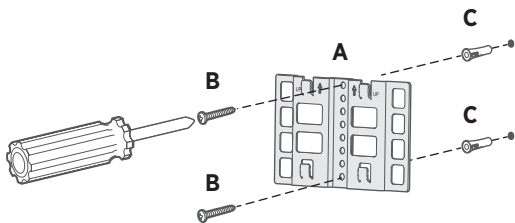

4



1

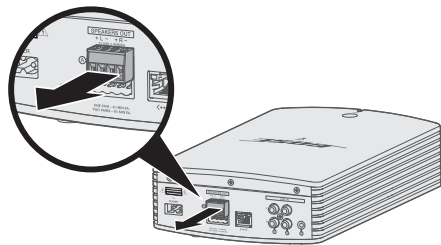

ブロックコネクタ A を取り外します。
1つのブロックコネクタで1組のスピーカーを接続できます。

2

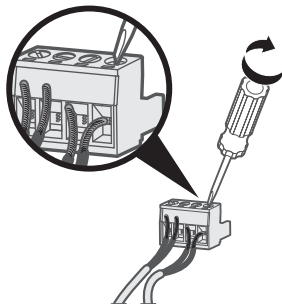

スピーカーケーブルをブロックコネクタ A にしっかりと接続します。

1. Left (左)側スピーカーケーブルの印のある方をプラス(+ L)側の端子に差し込み、印のない方をマイナス(L-)側の端子に差し込みます。
2. Right (右)側スピーカーケーブルの印のある方をプラス(+ R)側の端子に差し込み、印のない方をマイナス(R-)側の端子に差し込みます。

3

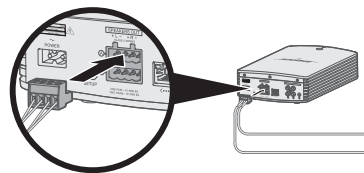

ブロックコネクタ A を再度取り付けます。

2組目のスピーカーを接続するには、手順1～3を繰り返してブロックコネクタ B に接続します。

注: スピーカーケーブルをスピーカーに接続する方法については、スピーカーの取扱説明書を参照してください。アンプが内蔵されていないスピーカーを最大2組まで接続できます。

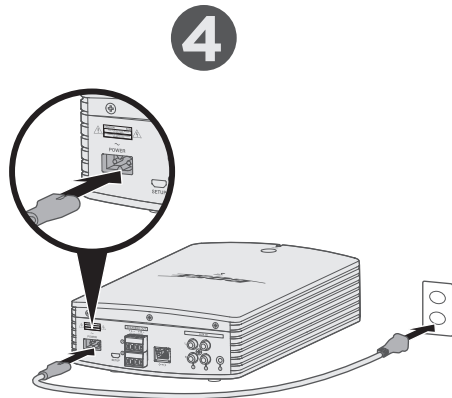

電源に接続します。

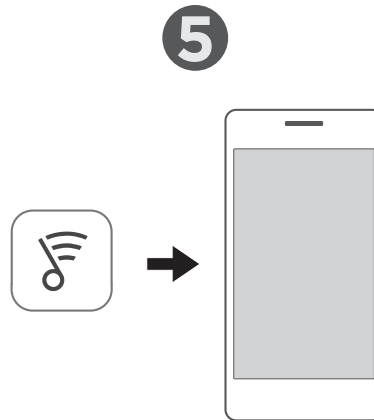

SoundTouch® appをダウンロードします。*

* パソコンを使用する場合は、global.Bose.com/Support/SA5に移動してアプリをダウンロードします。

詳しくは次のサイトをご覧ください: global.Bose.com/Support/SA5

壁面取り付け

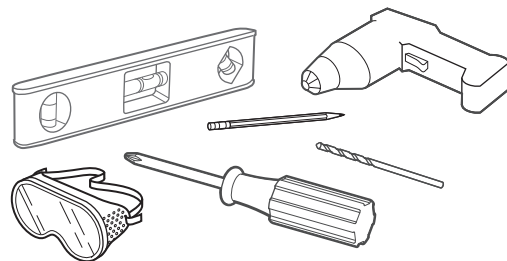
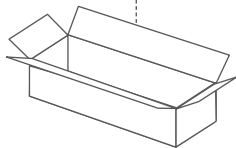
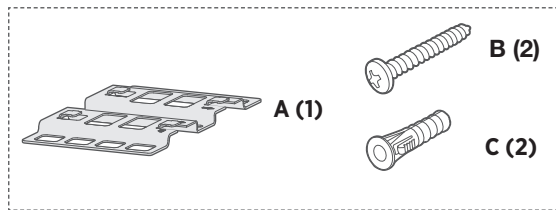

項目	木壁	板壁
壁の厚み	19 mm ($\frac{3}{4}$ インチ)以上	9.5 mm ($\frac{3}{8}$ インチ)以上
ドリルビット	2.38 mm ($\frac{3}{32}$ インチ)	6.35 mm ($\frac{1}{4}$ インチ)
皿木ネジ(2本)	M5 x 32 mm (#10 x 1 $\frac{1}{4}$ インチ)	M5 x 32 mm (#10 x 1 $\frac{1}{4}$ インチ)
ボードアンカー (2本)	使用しません	M5 (#10) ボードアンカー

1

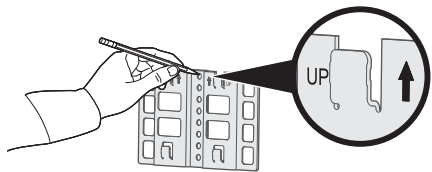

2

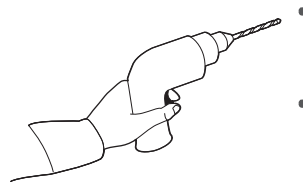

3

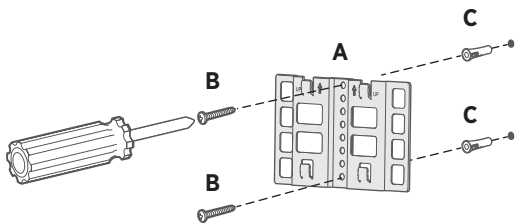

4



2

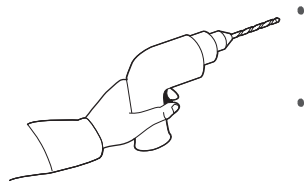

1

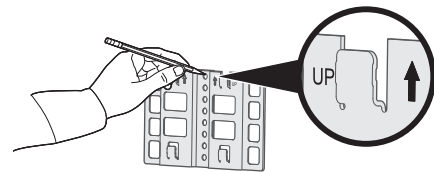

4

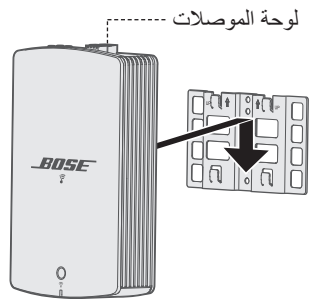

3

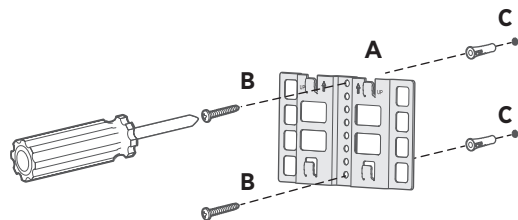

التثبيت بالحائط

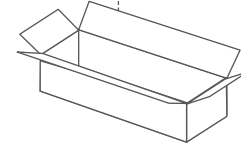
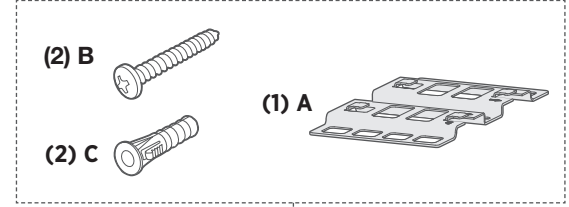
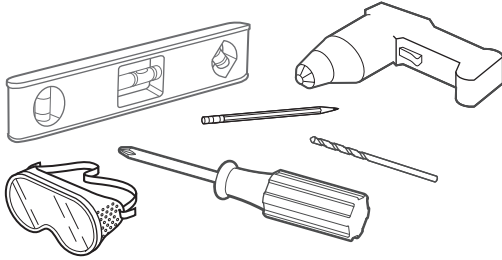

العنصر	الخشب	لوح حائط
سمك الحائط	$\frac{3}{4}$ بوصة (19 ملم) أو أكثر سمكاً	$\frac{3}{8}$ بوصة (9.5 ملم) أو أكثر سمكاً
لقمة الحفر	$\frac{3}{32}$ بوصة (2.38 ملم)	$\frac{1}{4}$ بوصة (6.35 ملم)
مسامير خشبية برأس فليبس (2)	$\frac{1}{4} \times 10\#$ بوصة (32 x M5 ملم)	$\frac{1}{4} \times 10\#$ بوصة (32 x M5 ملم)
مشابك بلاستيكية (2)	غير مستخدم	(M5) 10# مشابك بلاستيكية

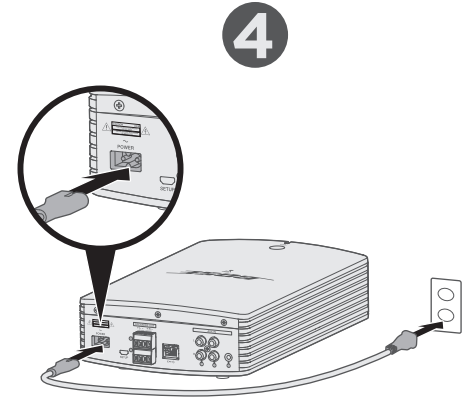
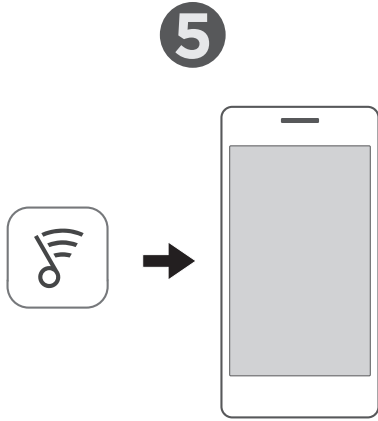

قم بتنزيل تطبيق **SoundTouch®**.*

*إذا كنت تستخدم جهاز كمبيوتر، فإذهب إلى الموقع global.Bose.com/Support/SA5 لتنزيل التطبيق.

التوصيل بمصدر طاقة.

هل لديك أي أسئلة؟ global.Bose.com/Support/SA5

1

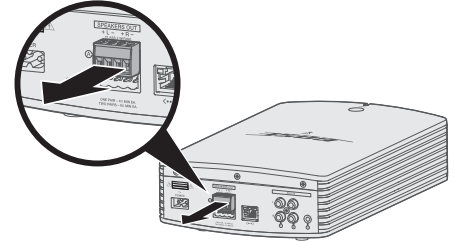

إزالة المحطة الطرفية A.

تقبل كل محطة طرفية زوج واحد من السماعات.

2

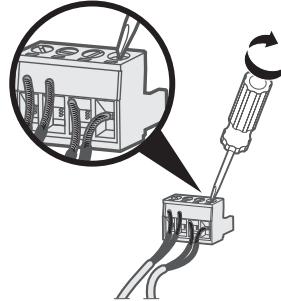

قم بياصال وتنشيت أسلاك السماعات بالمحطة الطرفية A.

1. أدخل سلك السماعة اليسرى المعلم في الطرف

الموجب **L +** والسلك العادي في الطرف السالب **L -**.

2. أدخل سلك السماعة اليمنى المعلم في الطرف الموجب **R +**

والسلك العادي في الطرف السالب **R -**.

3

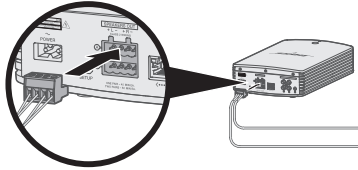

إعادة توصيل المحطة الطرفية A.

لإيصال زوج آخر من السماعات، أعد تكرار

الخطوات 1-3 باستخدام المحطة الطرفية B.

ملاحظة: راجع دليل المالك الخاص بالسماعات بشأن

التعليمات حول توصيل الطرف الآخر من أسلاك

السماعات إلى السماعات. يُمكنك توصيل ما يصل إلى

زوجين من السماعات تم فصل التيار عنها.



global.bose.com/Support/SA5



787178-0010

BOSE

©2016 Bose Corporation, The Mountain,
Framingham, MA 01701-9168 USA
AM787178 Rev. 00