



SOLO SOUNDBAR SERIES II

Please read and keep all safety, security, and use instructions.

CE Bose Corporation hereby declares that this product is in compliance with the essential requirements and other relevant provisions of Directive 2014/53/EU and all other applicable EU directive requirements. The complete declaration of conformity can be found at: www.Bose.com/compliance

Important Safety Instructions

1. Read these instructions.
2. Keep these instructions.
3. Heed all warnings.
4. Follow all instructions.
5. Do not use this apparatus near water.
6. Clean only with a dry cloth.
7. Do not block any ventilation openings. Install in accordance with the manufacturer's instructions.
8. Do not install near any heat sources such as radiators, heat registers, stoves, or other apparatus (including amplifiers) that produce heat.
9. Do not defeat the safety purpose of the polarized or grounding-type plug. A polarized plug has two blades with one wider than the other. A grounding type plug has two blades and a third grounding prong. The wide blade or the third prong are provided for your safety. If the provided plug does not fit into your outlet, consult an electrician for replacement of the obsolete outlet.
10. Protect the power cord from being walked on or pinched, particularly at plugs, convenience receptacles, and the point where they exit from the apparatus.
11. Only use attachments/accessories specified by the manufacturer.
12.  Use only with the cart, stand, tripod, bracket, or table specified by the manufacturer, or sold with the apparatus. When a cart is used, use caution when moving the cart/apparatus combination to avoid injury from tip-over.
13. Unplug this apparatus during lightning storms or when unused for long periods of time.
14. Refer all servicing to qualified personnel. Servicing is required when the apparatus has been damaged in any way, such as power-supply cord or plug is damaged, liquid has been spilled or objects have fallen into the apparatus, the apparatus has been exposed to rain or moisture, does not operate normally, or has been dropped.

WARNINGS/CAUTIONS



This symbol on the product means there are important operating and maintenance instructions in this guide.



Do not ingest battery, chemical burn hazard. The remote control supplied with this product contains a coin/button cell battery. If the coin/button cell battery is swallowed, it can cause severe internal burns in just 2 hours and can lead to death. Keep new and used batteries away from children. If the battery compartment does not close securely, stop using the remote control and keep it away from children. If you think batteries might have been swallowed or placed inside any part of the body, seek immediate medical attention. To avoid risk of explosion, fire or chemical burn, use caution in replacing the battery and replace only with an agency approved (e.g., UL) CR2032 or DL2032 3-volt lithium battery. Properly and promptly dispose of used batteries. Do not recharge, disassemble, heat above 212° F (100° C) or incinerate.



This product contains magnetic material. Consult your physician on whether this might affect your implantable medical device.

- To reduce the risk of fire or electrical shock, do NOT expose this product to rain, liquids or moisture.
- Do NOT expose this apparatus to dripping or splashing, and do not place objects filled with liquids, such as vases, on or near the product.
- Keep the product away from fire and heat sources. Do NOT place naked flame sources, such as lighted candles, on or near the product.
- Do NOT make unauthorized alterations to the product.
- Do NOT use a power inverter with this product.
- Do NOT use in vehicles or boats.
- The speaker wire and interconnect cables included with this system are not approved for in-wall installation. Please check your local building codes for the correct type of wire and cable required for in-wall installation.
- Use this product only with the power supply provided.
- Where the mains plug or appliance coupler is used as the disconnect device, the disconnect device shall remain readily operable.
- The product label is located on the bottom of the product.
- Do NOT expose products containing batteries to excessive heat (e.g. from storage in direct sunlight, fire or the like).
- Only use the mounting hardware supplied with this product.
- Do NOT mount on surfaces that are not sturdy, or that have hazards concealed behind them, such as electrical wiring or plumbing. If you are not sure about installing the bracket, contact a qualified professional installer. Ensure the bracket is installed according to local building codes.
- Only for mounting on the following surfaces:
 - Wallboard $\geq 3/8''$ (10 mm)
 - Masonry
 If mounted on surfaces other than stated above please contact a professional installer.
- Due to ventilation requirements, Bose does not recommend placing the product in a confined space such as in a wall cavity or in an enclosed cabinet.
- Do not place or install the bracket or product near any heat sources, such as fireplaces, radiators, heat registers or other apparatus (including amplifiers) that produce heat.

Solvent, lubricant, and cleaning agent warning

WARNING: Do not use hydrocarbon based solvents, lubricants or cleaning agents of any type on or around Bose speakers, and associated mounting hardware, during installation. The use of such hydrocarbon based lubricants, solvents or cleaning agents on or around the mounting anchors and screws can lead to degradation of the plastic material, possibly resulting in cracking and premature failure of the product.

NOTE: This equipment has been tested and found to comply with the limits for a Class B digital device, pursuant to Part 15 of the FCC Rules. These limits are designed to provide reasonable protection against harmful interference in a residential installation. This equipment generates, uses, and can radiate radio frequency energy and, if not installed and used in accordance with the instructions, may cause harmful interference to radio communications. However, there is no guarantee that interference will not occur in a particular installation. If this equipment does cause harmful interference to radio or television reception, which can be determined by turning the equipment off and on, the user is encouraged to try to correct the interference by one or more of the following measures:

- Reorient or relocate the receiving antenna.
- Increase the separation between the equipment and receiver.
- Connect the equipment into an outlet on a circuit different from that to which the receiver is connected.
- Consult the dealer or an experienced radio/TV technician for help.

Changes or modifications not expressly approved by Bose Corporation could void the user's authority to operate this equipment.

This device complies with part 15 of the FCC Rules and with ISED Canada license-exempt RSS standard(s). Operation is subject to the following two conditions: (1) This device may not cause harmful interference, and (2) this device must accept any interference received, including interference that may cause undesired operation.

This equipment should be installed and operated with minimum distance 20cm between the radiator and your body.

CAN ICES-3(B)/NMB-3(B)

The product, in accordance with the Ecodesign Requirements for Energy Related Products Directive 2009/125/EC, is in compliance with the following norm(s) or document(s): Regulation (EC) No. 1275/2008, as amended by Regulation (EU) No. 801/2013.

Required Power State Information	Power Modes	
	Standby	Networked Standby
Power consumption in specified power mode, at 230V/50Hz input	≤ 0.5 W	N/A*
Time after which equipment is automatically switched into mode	< 2.5 hours	N/A*
Power consumption in networked standby if all wired network ports are connected and all wireless network ports are activated, at 230V/50Hz input	N/A	N/A*
Network port deactivation/activation procedures. Deactivating all networks will enable standby mode.	<p>Bluetooth®: Deactivate by clearing the pairing list by pressing and holding the <i>Bluetooth</i> button for 10 seconds. Activate by pairing with a <i>Bluetooth</i> source.</p> <p>*product does not utilize a networked standby mode for a <i>Bluetooth</i> connection and does not have the ability to be configured to a network via Wi-Fi® or Ethernet.</p>	

External Power Supply Technical Information

The external power supply provided with the product, in accordance with the Ecodesign Requirements for Energy Related Products Directive 2009/125/EC, is in compliance with the following norms(s) or documents(s): Commission Regulation (EU) 2019/1782.

Manufacturer	Bose Products B.V.
Commercial registration number	36037901
Address	Gorslaan 60 1441 RG Purmerend The Netherlands
Model identifier	DT20V-1.8C-DC
Input voltage	100V-240V
Input AC frequency	50Hz/60Hz
Output voltage	20V DC
Output current	1.8A
Output power	36W
Average active efficiency	89.6%
Efficiency at low load (10%)	90.1%
No-load power consumption	0.08W

For Europe:

Frequency band of operation 2400 to 2483.5 MHz.

Maximum transmit power less than 20 dBm EIRP.

Maximum transmit power is below regulatory limits such that SAR testing is not necessary and exempt per applicable regulations.



This symbol means the product must not be discarded as household waste, and should be delivered to an appropriate collection facility for recycling. Proper disposal and recycling helps protect natural resources, human health and the environment. For more information on disposal and recycling of this product, contact your local municipality, disposal service, or the shop where you bought this product.

Management Regulation for Low-power Radio-frequency Devices

Article XII

According to “Management Regulation for Low-power Radio-frequency Devices” without permission granted by the NCC, any company, enterprise, or user is not allowed to change frequency, enhance transmitting power or alter original characteristic as well as performance to an approved low power radio-frequency devices.

Article XIV

The low power radio-frequency devices shall not influence aircraft security and interfere legal communications; If found, the user shall cease operating immediately until no interference is achieved. The said legal communications means radio communications operated in compliance with the Telecommunications Act.

The low power radio-frequency devices must be susceptible with the interference from legal communications or ISM radio wave radiated devices.



Date of Manufacture: The eighth digit in the serial number indicates the year of manufacture; “0” is 2010 or 2020.

China Importer: Bose Electronics (Shanghai) Company Limited, Part C, Plant 9, No. 353 North Riyang Road, China (Shanghai) Pilot Free Trade Zone

EU Importer: Bose Products B.V., Gorslaan 60, 1441 RG Purmerend, The Netherlands

Taiwan Importer: Bose Taiwan Branch, 9F-A1, No. 10, Section 3, Minsheng East Road, Taipei City 104, Taiwan
Phone Number: +886-2-2514 7676

Mexico Importer: Bose de México, S. de R.L. de C.V., Paseo de las Palmas 405-204, Lomas de Chapultepec, 11000 México, D.F. Phone Number: +5255 (5202) 3545

Input Rating: 20V --- 30W MAX

The CMIIT ID is located on the bottom of the soundbar.

California: Contains lithium ion battery with Perchlorate Material - special handling may apply.
See www.dtsc.ca.gov/hazardouswaste/perchlorate

China Restriction of Hazardous Substances Table

Names and Contents of Toxic or Hazardous Substances or Elements						
Part Name	Toxic or Hazardous Substances and Elements					
	Lead (Pb)	Mercury (Hg)	Cadmium (Cd)	Hexavalent (CR(VI))	Polybrominated Biphenyl (PBB)	Polybrominated diphenylether (PBDE)
PCBs	X	0	0	0	0	0
Metal Parts	X	0	0	0	0	0
Plastic Parts	0	0	0	0	0	0
Speakers	X	0	0	0	0	0
Cables	X	0	0	0	0	0
This table is prepared in accordance with the provisions of SJ/T 11364. O: Indicates that this toxic or hazardous substance contained in all of the homogeneous materials for this part is below the limit requirement of GB/T 26572. X: Indicates that this toxic or hazardous substance contained in at least one of the homogeneous materials used for this part is above the limit requirement of GB/T 26572.						

Taiwan Restriction of Hazardous Substances Table

Equipment name: Powered Speaker, Type designation: 418775						
Unit	Restricted substances and its chemical symbols					
	Lead (Pb)	Mercury (Hg)	Cadmium (Cd)	Hexavalent chromium (Cr+6)	Polybrominated biphenyls (PBB)	Polybrominated diphenyl ethers (PBDE)
PCBs	-	o	o	o	o	o
Metal Parts	-	o	o	o	o	o
Plastic Parts	o	o	o	o	o	o
Speakers	-	o	o	o	o	o
Cables	-	o	o	o	o	o
Note 1: "o" indicates that the percentage content of the restricted substance does not exceed the percentage of reference value of presence.						
Note 2: The "-" indicates that the restricted substance corresponds to the exemption.						

Please complete and retain for your records

The serial and model numbers are located on the bottom of the soundbar and on the packaging for the remote.

Serial number: _____

Model number: 418775

Please keep your receipt with your owner's guide. Now is a good time to register your Bose product. You can easily do this by going to global.Bose.com/register

Security Information



This product contains software. Bose may provide updates from time to time, including those to address security issues that may impact product functionality. You are responsible for applying updates for the products you own, and may access them by contacting Bose customer service.

Visit: worldwide.Bose.com/contact

The *Bluetooth*[®] word mark and logos are registered trademarks owned by Bluetooth SIG, Inc. and any use of such marks by Bose Corporation is under license.

 **DOLBY AUDIO**[™] Manufactured under license from Dolby Laboratories. Dolby, Dolby Audio and the double-D symbol are trademarks of Dolby Laboratories.

 **HDMI**[™] The terms HDMI, HDMI High-Definition Multimedia Interface, and the HDMI logo are trademarks or registered trademarks of HDMI Licensing Administrator, Inc.

Bose, Bose Home Speaker, Bose Music, Bose Portable Home Speaker, Bose Solo Soundbar Series, Bose Soundbar, and SimpleSync are trademarks of Bose Corporation.

Bose Corporation Headquarters: 1-877-230-5639

©2020 Bose Corporation. No part of this work may be reproduced, modified, distributed, or otherwise used without prior written permission.

WHAT'S IN THE BOX

Contents 12

SOUNDBAR PLACEMENT

Recommendations..... 13
 Wall mount the soundbar 14
 Adjust audio for wall mounting..... 14

SET UP THE SOUNDBAR

Cable options 15
 Connect the soundbar to your TV 16
 Option 1: Optical (preferred)..... 16
 Option 2: Coaxial (not provided) 17
 Connect the soundbar to power..... 18
 Mounting ring..... 18
 Turn off your TV speakers 19
 Check for sound 19

SOUNDBAR CONTROLS

Remote functions..... 20
 Power..... 21
 Auto-wake 22
 Volume 23
 Sources 24
 Dialogue mode..... 25
 Adjust the bass 26
 Reset the bass..... 27
 Program a third-party remote 27

BLUETOOTH® CONNECTIONS

Connect a mobile device 28

Disconnect a mobile device..... 29

Reconnect a mobile device..... 29

Connect an additional mobile device 30

Switch between connected devices..... 30

Clear the soundbar device list 30

SOUNDBAR STATUS

Power, volume, and error status..... 31

Bluetooth status 31

ALTERNATE SETUP

No sound from a source(s) connected to your TV 32

No optical or coaxial ports on your TV 32

Connect a source to the soundbar 33

Connect a source’s analog port to the soundbar 34

Connect two sources to the soundbar..... 35

Use two sources connected to the soundbar..... 37

Connect a TV headphone port to the soundbar 38

CONNECT BOSE PRODUCTS

Connect a Bose Home Speaker or Soundbar 39

Compatible products 39

Connect using the Bose Music app 39

Reconnect to a Bose Home Speaker or Soundbar 40

CARE AND MAINTENANCE

Replace the remote battery..... 41

Clean the soundbar..... 42

Replacement parts and accessories..... 42

Limited warranty..... 42

TROUBLESHOOTING

Try these solutions first 43

Other solutions 43

CONTENTS

Confirm that the following parts are included:



Bose Solo Soundbar Series II

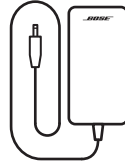

Power supply



Power cord*

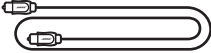

Optical cable



Remote
(battery provided)

* May ship with multiple power cords. Use the power cord for your region.

NOTE: If any part of the product is damaged, don't use it. Contact your authorized Bose dealer or Bose customer service.

Visit: worldwide.Bose.com/Support/SBSoloii

RECOMMENDATIONS

- Place the soundbar outside of and away from metal cabinets, other audio/video components, and direct heat sources.
- Place the soundbar directly below (preferred) or above your TV with the grille facing into the room.
- Place the soundbar on its rubber feet on a stable and level surface. For proper support, both feet must be resting on the surface. Vibration can cause the soundbar to move, particularly on smooth surfaces like marble, glass, or highly polished wood.
- If placing the soundbar on a shelf or TV stand, position the front of the soundbar as close as possible to the front edge of the shelf or stand for best sound quality.
- Keep the back side of the soundbar at least 0.4 in (1 cm) from any other surface. Blocking the ports on this side affects sound quality.
- Make sure there is an AC (mains) outlet nearby.
- To avoid wireless interference, keep other wireless equipment 1 – 3 ft (0.3 – 0.9 m) away from the soundbar.
- For best sound quality, don't place the soundbar in an enclosed cabinet or diagonally in a corner.
- Don't place any objects on top of the soundbar.

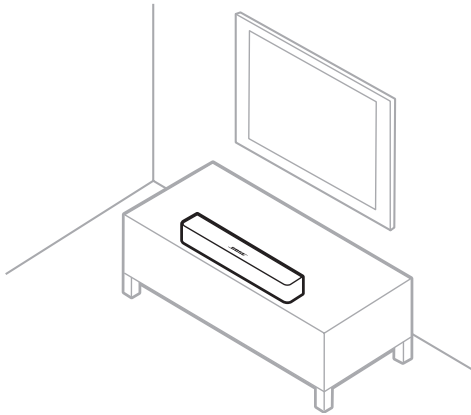

CAUTION: Do NOT place the soundbar on its front, back, or top when in use.

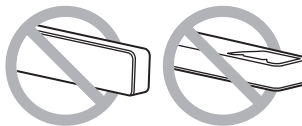

WALL MOUNT THE SOUNDBAR

You can mount the soundbar on a wall. Follow the installation instructions included with the soundbar.

CAUTION: Do NOT use any other hardware to mount the soundbar.

Adjust audio for wall mounting

On the remote, press and hold the Dialogue mode button  for 5 seconds until the status light on the soundbar blinks amber (see page 31).



NOTE: If you remove the soundbar from the wall, repeat to return the soundbar to default audio settings.

CABLE OPTIONS

Connect your TV to the soundbar using one of the two cable options.

- **Option 1:** Optical (preferred)
- **Option 2:** Coaxial (not provided)

NOTE: If your TV does not have an optical or coaxial port, see “Alternate Setup” on page 32.

1. On the back of your TV, locate the **Audio OUT** (optical) port panel.

NOTE: You must connect the audio cable through your Audio OUT panel.

Your TV's port panel may not appear as shown.
Look for the shape or color (coaxial) of the port.

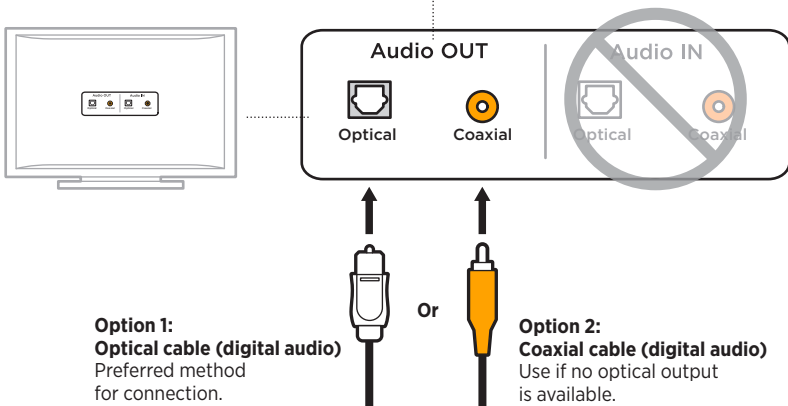

2. Choose an audio cable.

CONNECT THE SOUNDBAR TO YOUR TV

Option 1: Optical (preferred)

1. Remove the protective cap from both ends of the optical cable.



CAUTION: Make sure you have removed the protective cap from both ends of the optical cable. Inserting the plug with the cap on or in the wrong orientation can damage the plug and/or the port.

2. Align the plug on one end of the cable with your TV's **Optical OUT** port and insert the plug carefully.
3. Hold the plug at the other end of the optical cable with the Bose logo facing down.
4. Align the plug with the soundbar's **OPTICAL** port and insert the plug carefully.

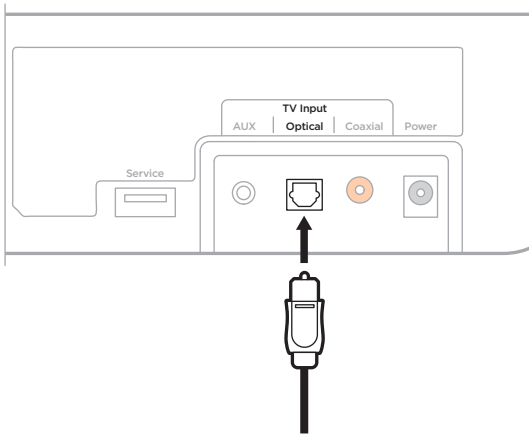

NOTE: The port has a hinged door that swings inward when inserting the plug.

5. Firmly push the plug into the port until you hear or feel a click.



Option 2: Coaxial (not provided)

1. Insert one end of the coaxial cable into your TV's coaxial port.
2. Insert the other end of the coaxial cable into the **Coaxial** port on the soundbar.

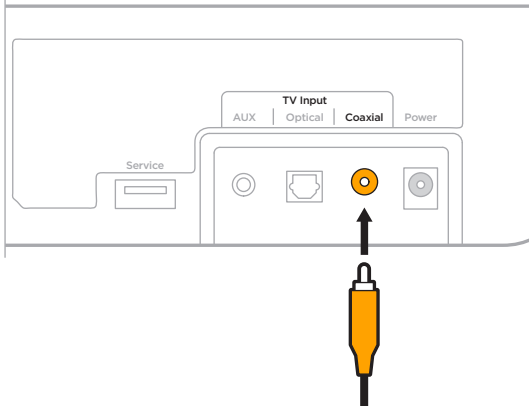

CONNECT THE SOUNDBAR TO POWER

1. Connect the power cord to the power supply.

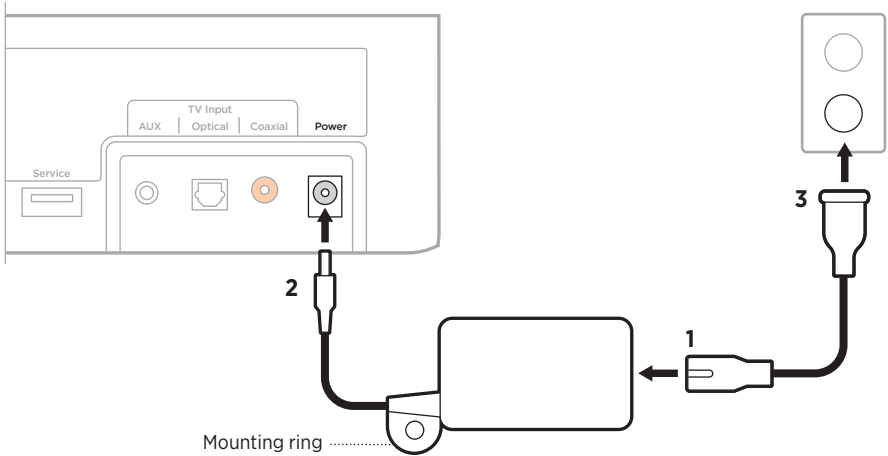

2. Connect the power supply into the **Power** port on the back of the soundbar.
3. Plug the other end of the power cord into a live AC (mains) outlet.

The soundbar powers on, and you hear a tone.

Mounting ring

To hide the power supply behind your mounted TV, attach the mounting ring to your TV's wall mount using zip ties or bread ties (not provided).

TURN OFF YOUR TV SPEAKERS

To avoid hearing distorted sound, turn off your TV speakers.

For more information, refer to your TV owner's guide.

TIP: The audio settings are usually found in the TV menu.

CHECK FOR SOUND

1. Power on your TV.
2. If you are using a cable/satellite box or other secondary source:
 - a. Power on this source.
 - b. Select the appropriate TV input.

3. Power on the soundbar (see page 21).

You hear sound coming from the soundbar.

4. On the remote, press the Mute button .

You don't hear sound coming from the TV speakers or soundbar.

NOTE: If you don't hear sound coming from the soundbar or hear sound coming from your TV speakers, see "Troubleshooting" on page 43.

REMOTE FUNCTIONS

Use the remote to control the soundbar and *Bluetooth* connections.

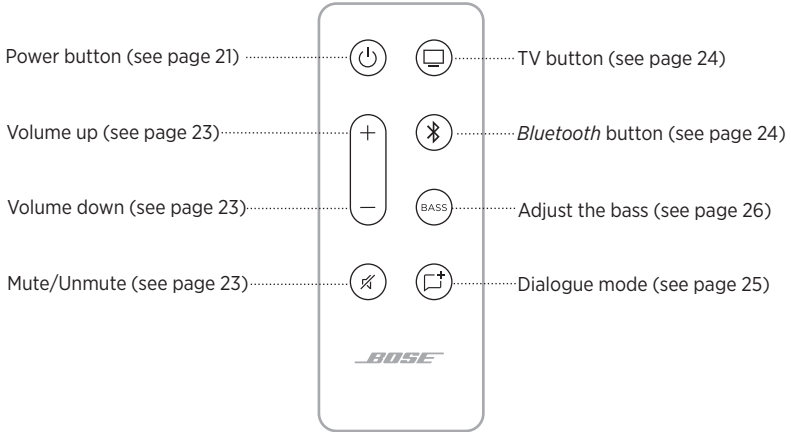

Power

On the remote, press the Power button  to power the soundbar on/off.



When powered on, the soundbar defaults to the last active source.

NOTES:

- When you plug the soundbar into an AC (mains) outlet, the soundbar automatically powers on.
- The first time the soundbar is powered on, the soundbar defaults to the TV  source.
- The soundbar powers off after 60 minutes of inactivity.

Auto-wake

You can set the soundbar to power on whenever a sound signal is received.

On the remote, to toggle between auto-wake and default power settings, press and hold the Power button  until you hear three tones and the status light on the soundbar blinks 3 times (see page 31).

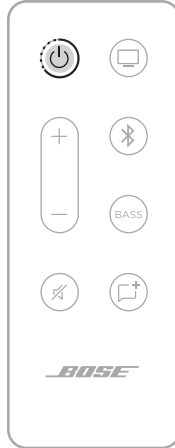

The status light glows dim amber when the soundbar is off and auto-wake is enabled.

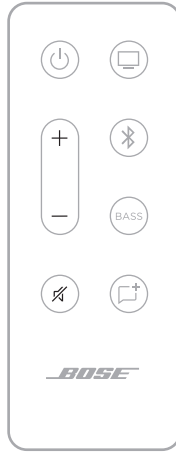

Volume



FUNCTION	WHAT TO DO
Volume up	<p>Press +.</p> <p>NOTE: To quickly increase the volume, press and hold +.</p>
Volume down	<p>Press -.</p> <p>NOTE: To quickly decrease the volume, press and hold -.</p>
Mute/Unmute	<p>Press .</p> <p>When audio is muted, the status light blinks green until audio resumes.</p> <p>NOTE: When Dialogue mode is enabled and audio is muted, the status light blinks amber.</p> <p>Tip: You can also press + to resume audio.</p>

Sources

You can control your TV and *Bluetooth* connections using your remote.

To select a source, press the button (TV button  or *Bluetooth* button ) on the remote.

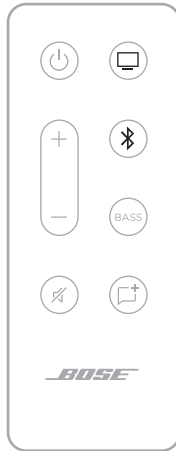

DIALOGUE MODE

Dialogue mode improves the clarity of dialogue and vocals in movies, TV programs, and podcasts by adjusting the audio balance of the system.

On the remote, press the Dialogue mode button  to switch between Dialogue mode and your default audio settings.

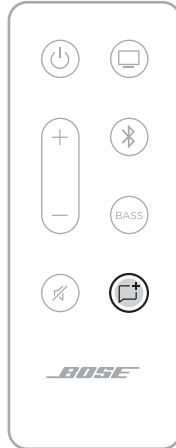

When Dialogue mode is enabled, the status light glows amber (see page 31).

NOTE: When you enable Dialogue mode, it stays enabled for your current source even if you switch to another source or turn off the soundbar. To disable Dialogue mode for a source, press  again.

ADJUST THE BASS

1. On the remote, press **BASS**.



On the soundbar, the status and *Bluetooth* lights blink white 3 times.

2. Adjust the bass by doing one of the following:
 - Press Volume up + to increase the bass.
 - Press Volume down — to decrease the bass.

The status and *Bluetooth* lights on the soundbar glow to show the current bass setting.

BASS SETTING	STATUS LIGHT	BLUETOOTH LIGHT
2 (maximum)	■	□
1	■	□
0 (default)	□	□
-1	□	■
-2 (minimum)	□	■

3. Press **BASS**.

The soundbar saves the current bass setting.

NOTE: For best sound quality for dialogue-only programs, such as news and talk shows, see "Dialogue mode" on page 25.

RESET THE BASS

On the remote, press and hold **BASS** until the status and *Bluetooth* lights on the soundbar blink 3 times.

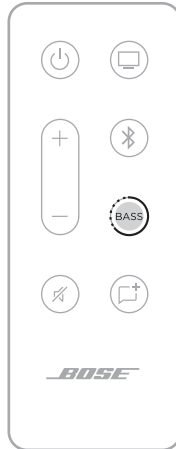

The bass setting reset to original factory settings.

PROGRAM A THIRD-PARTY REMOTE

You can program a third-party remote, such as your cable/satellite box remote, to control the soundbar. Refer to your third-party remote owner's guide or website for instructions.

Once programmed, the third-party remote performs basic functions such as power on/off and volume.

Bluetooth wireless technology lets you stream music from mobile devices such as smartphones, tablets, and laptop computers. Before you can stream music from a device, you must connect your device to the soundbar.

CONNECT A MOBILE DEVICE

1. On the remote, press and hold the *Bluetooth* button  until the *Bluetooth* light on the soundbar blinks blue.



2. On your mobile device, turn on the *Bluetooth* feature.

TIP: The *Bluetooth* menu is usually found in the Settings menu.

3. Select your soundbar from the device list.



Once connected, you hear a tone. The *Bluetooth* light glows solid white. Your soundbar appears in the mobile device list.

DISCONNECT A MOBILE DEVICE

Use your mobile device's *Bluetooth* menu to disconnect from the soundbar.

TIP: You can also disable the *Bluetooth* feature on your mobile device to disconnect. Disabling the *Bluetooth* feature disconnects all other devices.

RECONNECT A MOBILE DEVICE

On the remote, press the *Bluetooth* button ✱.

The soundbar tries to reconnect with the two most recently-connected devices. When connecting, the *Bluetooth* light on the soundbar blinks white.

NOTES:

- Make sure the *Bluetooth* feature is enabled on your mobile device.
- The device must be within 30 ft (9 m) of the soundbar and powered on.

CONNECT AN ADDITIONAL MOBILE DEVICE

You can store up to eight devices in the soundbar device list, and the soundbar can be actively connected to two devices at a time.

NOTE: You can play audio from only one device at a time.

1. On the remote, press and hold the *Bluetooth* button  until the *Bluetooth* light on the soundbar blinks blue.
2. On your mobile device, select your soundbar from the device list.

NOTE: Make sure the *Bluetooth* feature is enabled on your mobile device.

SWITCH BETWEEN CONNECTED DEVICES

1. Pause audio on your first device.
2. Play audio on your second device.

CLEAR THE SOUNDBAR DEVICE LIST

1. On the remote, press and hold  for 10 seconds until the *Bluetooth* light on the soundbar blinks blue.
2. Delete your soundbar from the *Bluetooth* list on your device.

All devices are cleared, and the soundbar is ready to connect (see page 28).

The LED lights located on the front of the soundbar show the soundbar status.



POWER, VOLUME, AND ERROR STATUS

Shows the power, media volume, and error status.

STATUS LIGHT ACTIVITY	SYSTEM STATE
Off	Power off (standby)
Glows solid green	Power on
Blinks green	Audio muted
Glows dim amber	Standby, auto-wake enabled
Glows solid amber	Dialogue mode
Blinks amber	Dialogue mode, audio muted
Blinks red	Error - contact Bose customer service

BLUETOOTH STATUS

Shows the *Bluetooth* connection status of mobile devices.

BLUETOOTH LIGHT ACTIVITY	SYSTEM STATE
Blinks blue	Ready to connect
Blinks white	Connecting
Glows solid white	Connected

You may need to use an alternate setup method for the following reasons:

- No sound from a source(s) connected to your TV.
- No optical or coaxial port on your TV.

NO SOUND FROM A SOURCE(S) CONNECTED TO YOUR TV

Some TVs don't deliver sound from connected sources to the soundbar. Use an alternate setup method to connect your source(s) to the soundbar.

PROBLEM	WHAT TO DO
No sound from a source connected to your TV	Connect your source to the soundbar using one of the two cable options (see page 33).
No sound from two sources connected to your TV	Connect your sources to the soundbar using Option 1 or Option 2 (see page 35).

NO OPTICAL OR COAXIAL PORTS ON YOUR TV

Some TVs don't have optical or coaxial ports. Use an alternate setup method to connect your TV to the soundbar.

PROBLEM	WHAT TO DO
TV only has an analog port	Connect your TV using a 3.5 mm to RCA stereo cable (not provided). See page 34.
TV only has a headphone port	Connect your TV using a 3.5 mm stereo cable (not provided). See page 38.
TV doesn't have audio outputs	Use the audio outputs on another source, such as a cable/satellite box, to connect to the soundbar (see page 33).

Connect a source to the soundbar

If you don't get sound from a source that's connected to your TV, such as a DVD/Blu-ray Disc™ player, cable/satellite box, game system, or DVR, connect the source directly to the soundbar using an audio cable.

CAUTION: If using an optical cable, remove the protective caps from both ends. Inserting the plug in the wrong orientation can damage the plug and/or the port.

1. On the back of your source, locate the **Audio OUT** (digital) panel.

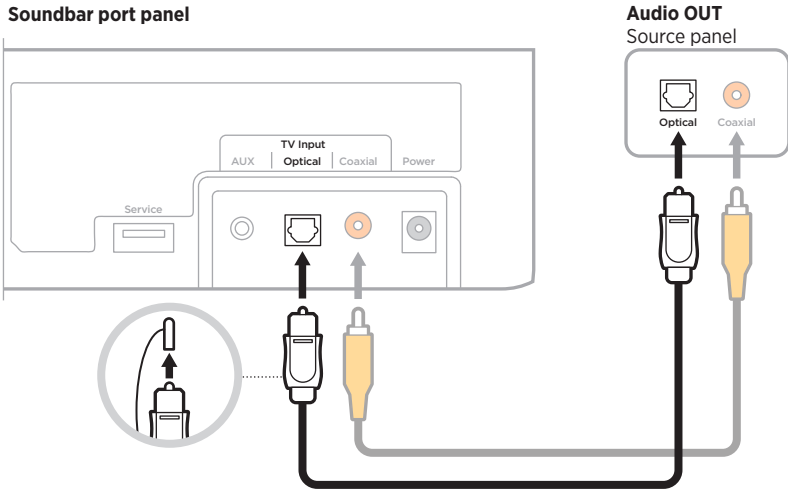

2. Choose an audio cable.
3. If you haven't already, disconnect your TV from the soundbar.
4. Connect the audio cable from your source's **Audio OUT** (digital) panel to the soundbar.

NOTE: Don't disconnect your source's video cable, such as an HDMI cable, from your TV.

Connect a source's analog port to the soundbar

If your source doesn't have an optical or coaxial port and only has analog ports (red and white), use a 3.5 mm to RCA stereo cable (not provided) to connect to the soundbar.

1. If you haven't already, disconnect your TV from the soundbar.
2. Insert the RCA analog cable into the **Audio OUT** RCA (red and white) ports on your source.
3. Insert the stereo plug into the soundbar's AUX port.

Soundbar port panel

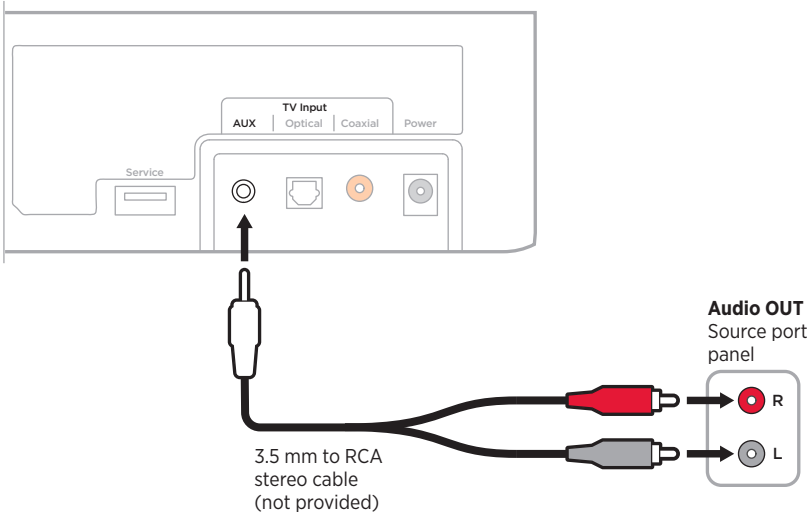

Connect two sources to the soundbar

If you don't get sound from any source that's connected to your TV, such as a DVD/Blu-ray Disc™ player, cable/satellite box, game system, or DVR, connect the source directly to the soundbar. Use only one audio cable for each source.

1. On the back of each source, locate the **Audio OUT** (digital) panel.
2. Choose a separate audio cable for each source using either Option 1 or Option 2 (see page 36).

NOTE: You MUST use either Option 1 or Option 2. Do not use the coaxial cable (not provided) and optical cable at the same time.

3. If you haven't already, disconnect your TV from the soundbar.
4. Separately connect the audio cable from each source's **Audio OUT** (digital) panel to the soundbar.

NOTE: Do not disconnect your source's video cable, such as an HDMI cable, from your TV.

Option 1

This figure shows two source connections using an optical cable and 3.5 mm to RCA stereo cable (not provided).

CAUTION: If using an optical cable, remove the protective caps from both ends. Inserting the plug in the wrong orientation can damage the plug and/or the port.

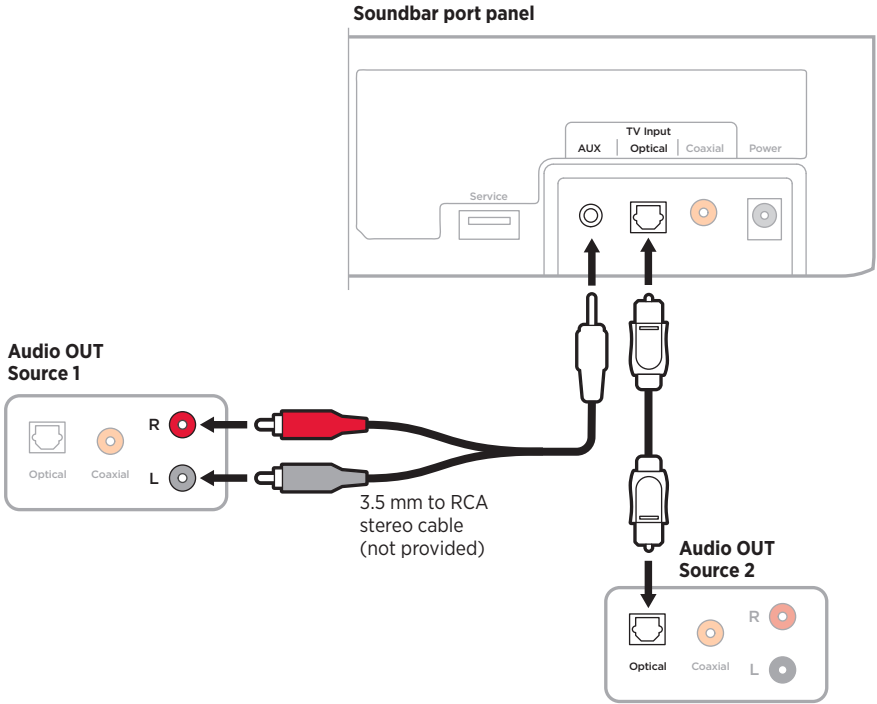

Option 2

This figure shows two source connections using a coaxial cable (not provided) and 3.5 mm to RCA stereo cable (not provided).

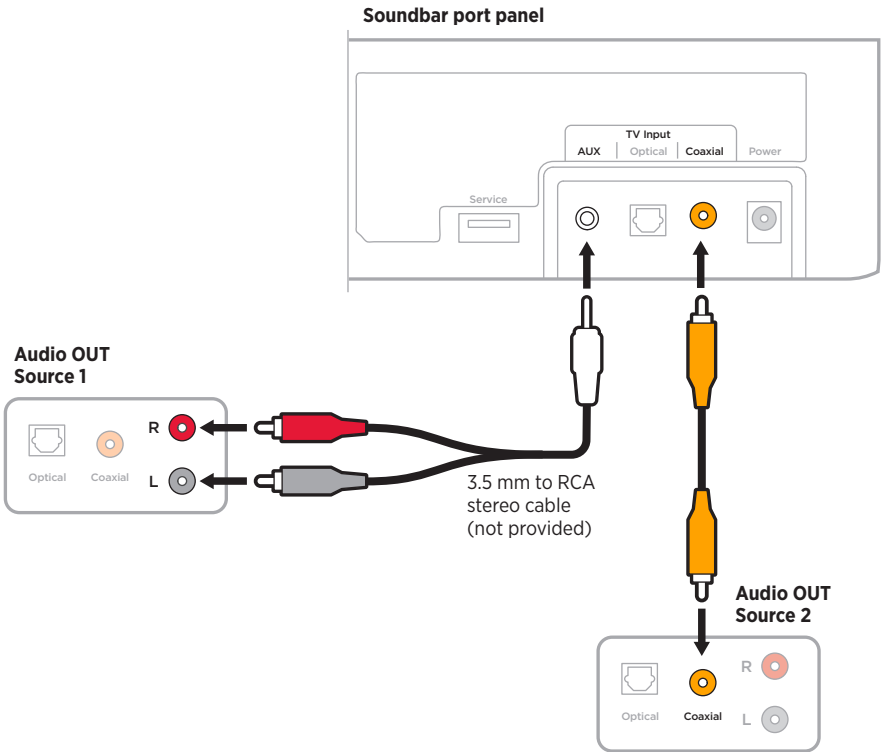

Use two sources connected to the soundbar

Power off sources when not in use. In order for one source to deliver audio to the soundbar, your other source must be off.

Connect a TV headphone port to the soundbar

If your TV only has a headphone port, use a 3.5 mm stereo cable (not provided) to connect to the soundbar.

1. Insert one end of a 3.5 mm stereo cable into the TV headphones port.
2. Insert the other end of the cable into the AUX port on the soundbar.

Soundbar port panel

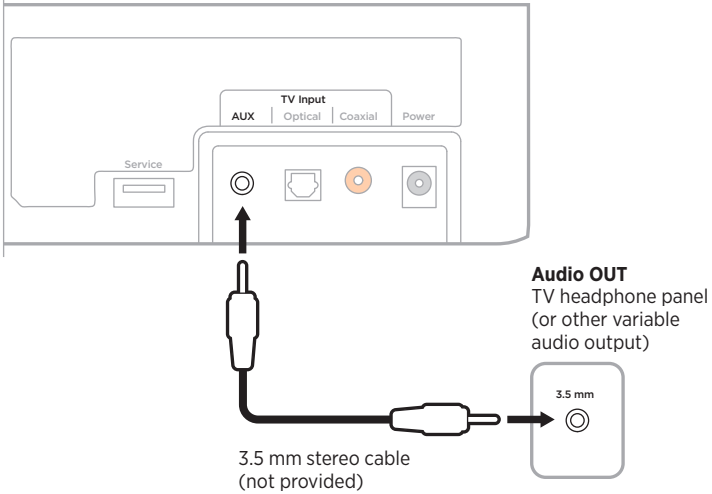

3. Make sure your TV speakers are on.
Refer to your TV owner's guide for more information.
4. To ensure optimal volume control from the soundbar:
 - a. Set your TV volume to 75% of maximum.
 - b. Set the soundbar volume using the remote.

CONNECT A BOSE HOME SPEAKER OR SOUNDBAR

With Bose SimpleSync technology, you can connect your Bose Solo Soundbar Series II to a Bose Home Speaker or Bose Soundbar to listen to the same song in two different rooms at the same time.

NOTE: SimpleSync technology has a *Bluetooth* range of 30 ft (9 m). Walls and construction materials can affect reception.

Compatible products

You can connect your Bose Solo Soundbar Series II to any member of the Bose Home Speaker family.

Popular compatible products include:

- Bose Soundbar 700
- Bose Soundbar 500
- Bose Home Speaker 500
- Bose Home Speaker 300
- Bose Portable Home Speaker

New products are added periodically. For a complete list and more information, visit: worldwide.Bose.com/Support/Groups

Connect using the Bose Music app

1. On your Bose Solo Soundbar Series II remote, press and hold the *Bluetooth* button  until the *Bluetooth* light on your Bose Solo Soundbar Series II blinks blue.
2. In the Bose Music app, from the **My Bose** screen, select your Bose Home Speaker or Bose Soundbar.

NOTE: To return to the **My Bose** screen, tap  in the top-left corner of the screen.

3. Tap the product image in the bottom-right corner of the screen.
4. Tap **Group Speakers**.
5. Follow the app instructions to connect a new *Bluetooth* device using SimpleSync.

NOTES:

- Make sure that your Bose Solo Soundbar Series II is within 30 ft (9 m) of your Bose Home Speaker or Bose Soundbar.
- You can connect your Bose Solo Soundbar Series II to only one product at a time.

RECONNECT TO A BOSE HOME SPEAKER OR SOUNDBAR

Power on your Bose Solo Soundbar Series II (see page 21).

Your Bose Solo Soundbar Series II tries to connect to the two most recently-connected *Bluetooth* devices, including your Bose Home Speaker or Bose Soundbar.

NOTES:

- Your Bose Home Speaker or Bose Soundbar must be within range (30 ft or 9 m) and powered on.
- If your Bose Solo Soundbar Series II doesn't connect, connect using the Bose Music app. You can access this option from the Settings menu.

REPLACE THE REMOTE BATTERY

The soundbar remote uses coin cell battery CR2032.

1. Turn the battery compartment cover left (counter-clockwise) and remove the cover.

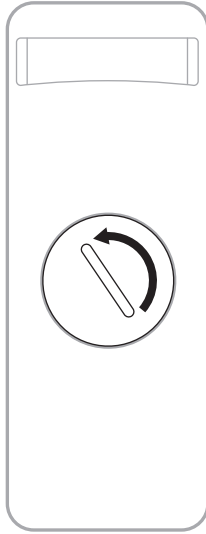

2. Insert the new battery flat side up, with the + symbol facing up.

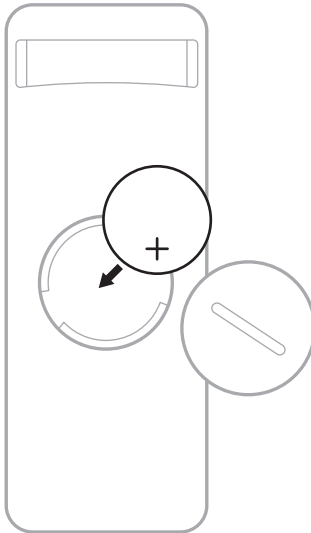

3. Reset the cover and turn it right (clockwise) to lock in place.

CLEAN THE SOUNDBAR

Clean the exterior of the soundbar with a soft dry cloth.

CAUTION:

- Do NOT allow liquids to spill onto the soundbar or into any openings.
- Do NOT blow air into the soundbar.
- Do NOT use a vacuum to clean the soundbar.
- Do NOT use any sprays near the soundbar.
- Do NOT use any solvents, chemicals, or cleaning solutions containing alcohol, ammonia, or abrasives.
- Do NOT allow objects to drop into any openings.

REPLACEMENT PARTS AND ACCESSORIES

Replacement parts and accessories can be ordered through Bose customer service.

Visit: worldwide.Bose.com/support/SBSoloi

LIMITED WARRANTY

The soundbar is covered by a limited warranty. Visit our website at global.Bose.com/warranty for details of the limited warranty.

To register your product, visit global.Bose.com/register for instructions. Failure to register will not affect your limited warranty rights.

TRY THESE SOLUTIONS FIRST

If you experience problems with the soundbar:

- Make sure the soundbar is connected to a live AC (mains) outlet.
- Secure all cables and make sure all connections are correct.
- Check the status lights (see page 31).
- Move the soundbar 1 – 3 ft (0.3 – 0.9 m) away from possible interference (wireless routers, cordless phones, televisions, microwaves, etc.).
- Move the soundbar within the recommended range of your mobile device for proper operation.
- Place the soundbar according to the placement guidelines (see page 13).
- Unplug the power cord for at least 1 minute and reconnect.

OTHER SOLUTIONS

If you could not resolve your issue, see the table below to identify symptoms and solutions to common problems. If you are unable to resolve your issue, contact Bose customer service.

Visit: worldwide.Bose.com/contact

SYMPTOM	SOLUTION
Remote is inconsistent or doesn't work	<p>Check the battery to see if it's installed properly or if it needs to be replaced (see page 41).</p> <p>Point the remote directly at the soundbar.</p> <p>Check that the status light blinks when you press the Volume up, Volume down, or Mute/Unmute buttons on the remote.</p> <p>Unplug the power cord for at least 1 minute and reconnect.</p>

SYMPTOM	SOLUTION
<p>No sound</p>	<p>Unmute the soundbar.</p> <p>Increase the volume.</p> <p>Plug the audio cable into a port on your TV labelled Audio Output or Audio OUT, not Audio Input or Audio IN.</p> <p>Use only one audio cable.</p> <p>If you are using a cable/satellite box or other secondary source for sound, select the correct TV input.</p> <p>Enable your TV's audio output and select the correct setting, such as Stereo or 5.1 Channel Audio. Refer to your TV owner's guide for more information.</p> <p>Use an alternate setup method (see page 32).</p> <p>If connecting to two sources:</p> <ul style="list-style-type: none"> • Power off the other source. • Make sure that you are not using an optical cable and coaxial cable. <p>If the soundbar is connected to a TV output labelled VARIABLE (VAR), turn off your TV speakers, set your TV volume to 75% of maximum, and unmute your TV.</p> <p>If connecting through a TV headphone output, increase your TV volume to the maximum limit.</p>
<p>Sound is coming from TV speaker</p>	<p>Turn off your TV speakers (see page 19).</p> <p>Mute or decrease the TV volume.</p>

SYMPTOM	SOLUTION
Soundbar doesn't play audio from Bluetooth device	<p>On the soundbar:</p> <ul style="list-style-type: none"> - Connect a device (see page 28). - Clear the soundbar device list (see page 30). - Try connecting a different device. <p>On your <i>Bluetooth</i> device:</p> <ul style="list-style-type: none"> - Turn the <i>Bluetooth</i> feature off and then on. - Remove the soundbar from the <i>Bluetooth</i> menu. Connect again. - Use a different music source. - Check your <i>Bluetooth</i> device for compatibility. Refer to your <i>Bluetooth</i> device owner's guide. <p>Increase the volume on the soundbar, mobile device, and music source.</p> <p>Make sure you are using the correct device.</p> <p>If more than one <i>Bluetooth</i> device is connected, pause audio on one device and play audio on the second device.</p> <p>Disconnect other <i>Bluetooth</i> devices when not in use.</p> <p>See "No sound" on page 44 or "Distorted sound."</p>
Distorted sound	<p>If the soundbar is connected to a TV output labeled VARIABLE (VAR), reduce the TV volume.</p> <p>Connect your source to the soundbar (see page 33).</p> <p>If wall mounting the soundbar, adjust the audio (see page 14).</p>
Soundbar doesn't connect with a Bose Home Speaker or Bose Soundbar	<p>Make sure your soundbar is ready to connect:</p> <p>On your Bose Solo Soundbar Series II remote, press and hold the <i>Bluetooth</i> button  until the <i>Bluetooth</i> light on your Bose Solo Soundbar Series II blinks blue.</p> <p>Make sure that your Bose Solo Soundbar Series II is within 30 ft (9 m) of your Bose Home Speaker or Bose Soundbar.</p>
Soundbar doesn't reconnect to a previously-connected Bose Home Speaker or Bose Soundbar	<p>Connect using the Bose Music app. You can access this option from the Settings menu.</p>
Delayed audio when connected to a Bose Home Speaker or Bose Soundbar	<p>Visit btu.Bose.com and check for available software updates.</p>



850858-0010