

BOSE

**VIRTUALLY
INVISIBLE[®] 300**
WIRELESS SURROUND SPEAKERS



OWNER'S GUIDE • BRUGERVEJLEDNING
BEDIENUNGSANLEITUNG • GEBRUIKERSHANDLEIDING
GUÍA DEL USUARIO • KÄYTTÖOHJE • NOTICE D'UTILISATION
MANUALE DI ISTRUZIONI • KEZELÉSI ÚTMUTATÓ
BRUKERVEILEDNING • PODRĘCZNIK UŻYTKOWNIKA
MANUAL DO PROPRIETÁRIO • BRUKSANVISNING
កម្រិតដ៏តូច • 사용자 안내서 • 用户指南 • 使用者指南 • 取扱説明書 • دليل المالك

IMPORTANT SAFETY INSTRUCTIONS

Please read and keep all safety and use instructions

Important Safety Instructions

1. Read these instructions.
2. Keep these instructions.
3. Heed all warnings.
4. Follow all instructions.
5. Do not use this apparatus near water.
6. Clean only with a dry cloth.
7. Do not block any ventilation openings. Install in accordance with the manufacturer's instructions.
8. Do not install near any heat sources such as radiators, heat registers, stoves, or other apparatus (including amplifiers) that produce heat.
9. Protect the power cord from being walked on or pinched particularly at plugs, convenience receptacles, and the point where they exit from the apparatus.
10. Only use attachments/accessories specified by the manufacturer.
11. Unplug this apparatus during lightning storms or when unused for long periods of time.
12. Refer all servicing to qualified personnel. Servicing is required when the apparatus has been damaged in any way, such as power-supply cord or plug is damaged, liquid has been spilled or objects have fallen into the apparatus, the apparatus has been exposed to rain or moisture, does not operate normally, or has been dropped.



This symbol means there is uninsulated, dangerous voltage within the product enclosure that may constitute a risk of electrical shock.



This symbol means there are important operating and maintenance instructions in this guide.



This product contains magnetic material. Consult your physician on whether this might affect your implantable medical device.

- To reduce the risk of fire or electrical shock, do NOT expose this product to rain, liquids or moisture.
- Do NOT expose this product to dripping or splashing, and do not place objects filled with liquids, such as vases, on or near the product.
- Keep the product away from fire and heat sources. Do NOT place naked flame sources, such as lighted candles, on or near the product.
- Do NOT make unauthorized alterations to this product.
- Do NOT use a power inverter with this product.
- Do NOT use in vehicles or boats.
- The speaker wire and interconnect cables included with this system are not approved for in-wall installation. Please check your local building codes for the correct type of wire and cable required for in-wall installation.
- Where the mains plug or an appliance coupler is used as the disconnect device, the disconnect device shall remain readily operable.



仅适用于 2000m 以下地区安全使用
Use at altitude less than 2000 meters only.

- Due to ventilation requirements, Bose does not recommend placing the product in a confined space such as in a wall cavity or in an enclosed cabinet.
- The product label is located on the bottom of the product.

REGULATORY INFORMATION

This device complies with part 15 of the FCC Rules and with Industry Canada license-exempt RSS standard(s). Operation is subject to the following two conditions: (1) This device may not cause harmful interference, and (2) this device must accept any interference received, including interference that may cause undesired operation.

This device complies with FCC and Industry Canada radiation exposure limits set forth for general population. This equipment should be installed and operated with a minimum distance of 20 cm between radiator and your body. This transmitter must not be co-located or operating in conjunction with any other antenna or transmitter.

This device is for indoor use only to reduce the potential for harmful interference to other co-channel systems.

W52 for Indoor Use Only

Receiver Category = 2

CE Bose Corporation hereby declares that this product is in compliance with the essential requirements and other relevant provisions of Directive 2014/53/EU and all other EU directive requirements. The complete declaration of conformity can be found at: www.Bose.com/compliance

Date of Manufacture: The eighth digit in the serial number indicates the year of manufacture; “7” is 2007 or 2017.

The *Bluetooth*® word mark and logos are registered trademarks owned by Bluetooth SIG, Inc. and any use of such marks by Bose Corporation is under license.

SoundTouch and the wireless note design are registered trademarks of Bose Corporation in the U.S. and other countries.

Wi-Fi is a registered trademark of Wi-Fi Alliance®.

Bose Corporation Headquarters: 1-877-230-5639

©2017 Bose Corporation. No part of this work may be reproduced, modified, distributed or otherwise used without prior written permission.

CONTENTS

Getting Started

Building your entertainment system.....	5
Unpacking.....	5
Placement guidelines.....	6
Mounting the speakers.....	7

Setting Up the Speakers

Connecting the adapters.....	8
Identifying switch settings on the wireless receivers.....	9
Connecting the speakers.....	9
Connecting to power.....	10

Finishing Setup

Pairing with a SoundTouch® 300 soundbar.....	11
Checking for sound.....	12
About ADAPTIQ® audio calibration.....	12
Running ADAPTIQ® audio calibration.....	12

Getting System Information

System status indicators.....	14
-------------------------------	----

Care and Maintenance

Cleaning.....	15
Customer service.....	15
Limited warranty information.....	15
Technical information.....	15
SERVICE connector.....	16

Troubleshooting

Common solutions.....	17
Unable to complete ADAPTIQ® audio calibration.....	19

Building your entertainment system

The Virtually Invisible® 300 wireless rear speakers are part of a modular home entertainment system. They are compatible with the SoundTouch® 300 soundbar and Acoustimass® 300 wireless bass module (not provided). You can wirelessly pair the bass module and surround speakers at any time for an even richer, more immersive sound.

To purchase these systems, contact your local Bose® dealer or visit www.Bose.com

Unpacking

Carefully unpack the carton and confirm that the following parts are included:

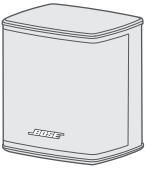

Virtually Invisible® 300 speaker (2)



Wireless receiver (2)



AC2 adapter (2)

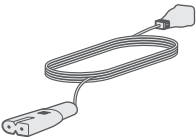

Power cord (2)*

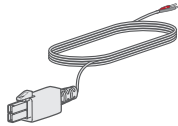

Two-pin speaker cable (2)

*May ship with multiple power cords. Use the power cord for your region.

Note: If any part is damaged, do not use it. Contact your authorized Bose dealer or Bose customer service.

Placement guidelines

To avoid interference, keep other wireless equipment 1 – 3 ft. (0.3 – 0.9 m) away from the wireless receivers. Place the speakers and wireless receivers outside and away from metal cabinets, other audio/video components and direct heat sources.

Component	Placement recommendation
Rear speakers	<ul style="list-style-type: none"> Place the speakers on their rubber feet on a stable and level surface. Place the speakers at ear height or higher in the back of the room. If placing the speakers in an enclosed bookcase shelf, position them at the front edge of the shelf. For a sound that is directed straight at the listener, aim the speakers in towards the listener. For a sound that reflects off the walls to fill the room, aim the speakers out towards a rear or side wall.
Wireless receivers	<ul style="list-style-type: none"> Confirm that the switch on one wireless receiver is set to R (right). Confirm that the switch on the other wireless receiver is set to L (left). Facing the TV, place the speaker and R wireless receiver on the right side of the room. Facing the TV, place the speaker and L wireless receiver on the left side of the room. Make sure there is an AC (mains) outlet near each wireless receiver.

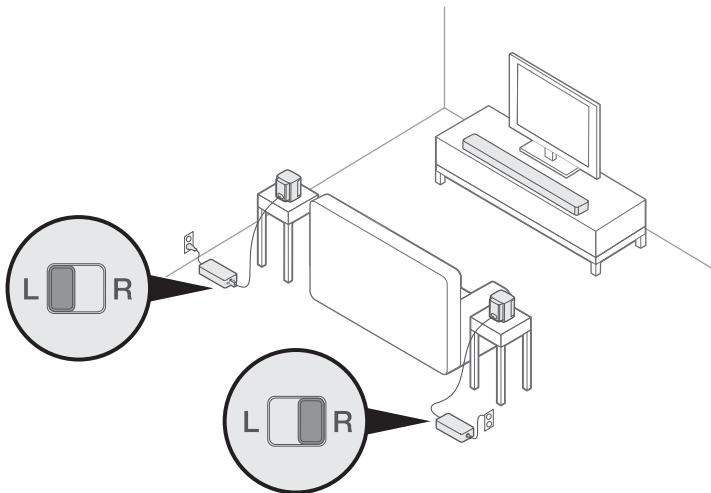

Mounting the speakers

You can mount the speakers on wall brackets, ceiling mounts, floor stands or table stands. To purchase these accessories, contact your local Bose® dealer or visit www.Bose.com

CAUTION: Only use Bose hardware to mount the speakers. Using unauthorized mounts may damage your Bose system and its components.

Connecting the adapters

1. Using the screwdriver, turn the screws to the left (counterclockwise) to loosen the wire terminals.

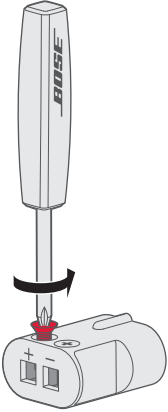

2. Insert the red, stripped end of the two-pin cable marked + into the red + terminal.
3. Insert the black, stripped end of the two-pin cable into the silver – terminal.

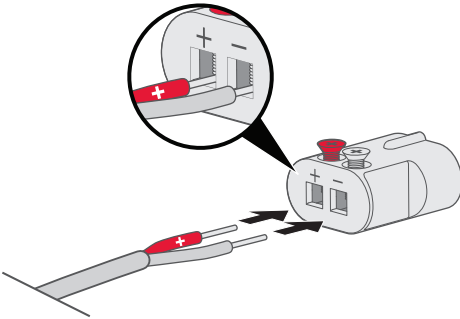

Note: Be sure to only insert the stripped and tinned portions of each exposed wire to avoid clamping the wire's insulation.

4. Using the screwdriver, turn the screws to the right (clockwise) to secure the wires into the terminals.
5. Repeat steps 1 - 4 to connect the other adapter.

Identifying switch settings on the wireless receivers

Your speakers connect to wireless receivers to communicate with the SoundTouch® 300 soundbar. The receivers come preset to a left and right channel out of the box. You can use the switch on the front of the receiver to adjust the channel settings.

1. Confirm that the switch on one wireless receiver is set to **R** (right).
2. Confirm that the switch on the other wireless receiver is set to **L** (left).

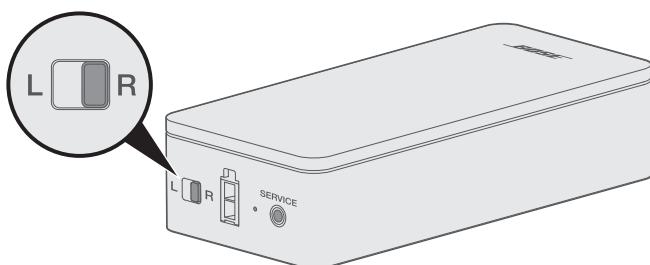

Note: Make sure that one wireless receiver is always set to **L** (left) and the other is set to **R** (right).

Connecting the speakers

1. Insert the adapter into the back of your speaker.
2. Insert the other end of the two-pin cable into your wireless receiver.

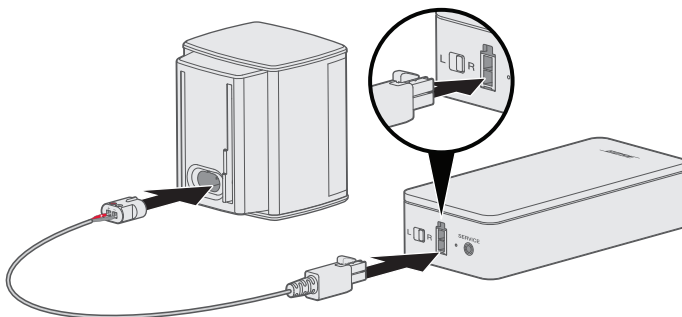

You hear or feel a click.

3. Repeat steps 1 – 2 to connect your other speaker.

Connecting to power

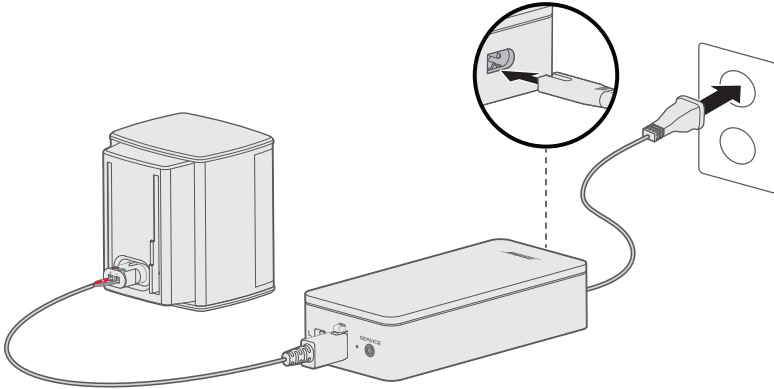

1. Connect one end of the power cord into your wireless receiver.
2. Plug the other end of the power cord into an AC (mains) outlet.





3. Repeat steps 1 - 3 to set up your other speaker.

Pairing with a SoundTouch® 300 soundbar

To wirelessly pair your rear speakers to a SoundTouch® 300 soundbar, you need to place the soundbar into pairing mode using the remote control.

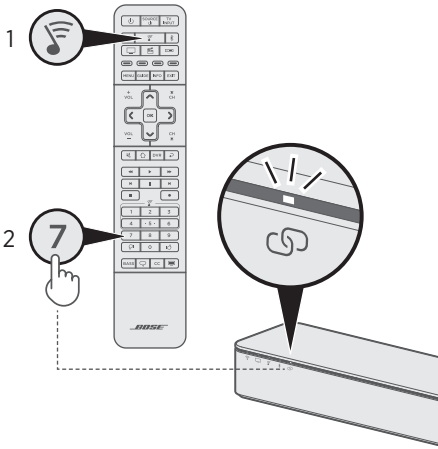
1. On the SoundTouch® 300 remote control, press the SoundTouch® button .
2. Press and hold **7** until the connectivity indicator  on the soundbar blinks white.



Once paired, your speakers emit a tone. The LED indicator on the back of the wireless receiver and the  indicator on the soundbar glow white.

Note: If your speakers don't pair with the soundbar, see "Troubleshooting" on page 17.

Checking for sound

1. Power on your TV.
2. If you are using a cable/satellite box or other secondary source:
 - Power on this source.
 - If your secondary source is connected to your TV, select the appropriate TV input. If you have not programmed the SoundTouch® 300 remote control, you may need to use a different remote.
3. Power on the SoundTouch® 300 soundbar.

You hear sound coming from your rear speakers.

Note: If you do not hear sound from the rear speakers, see “Troubleshooting” on page 17. If you do not hear sound from your soundbar, refer to the SoundTouch® 300 owner’s guide.

About ADAPTiQ® audio calibration

After connecting your rear speakers to the SoundTouch® 300 soundbar, run ADAPTiQ® audio calibration for the best acoustic performance. ADAPTiQ customizes the sound of the system to the acoustics of your listening area by taking five audio measurements. To run an audio calibration, you need 10 minutes when the room is quiet.

During ADAPTiQ, a microphone on the top of the ADAPTiQ headset (provided with the SoundTouch® 300 soundbar) measures the sound characteristics of your room to determine optimal sound quality.

If you no longer have the ADAPTiQ headset, contact Bose® customer service for a replacement.



Note: If you are also pairing the Acoustimass® 300 wireless bass module with the soundbar, pair the bass module before running ADAPTiQ audio calibration. Refer to the Acoustimass® 300 quick start guide or owner’s guide.

Running ADAPTiQ® audio calibration

1. Insert the ADAPTiQ® headset cable into the **ADAPTiQ** connector on the back of the soundbar.

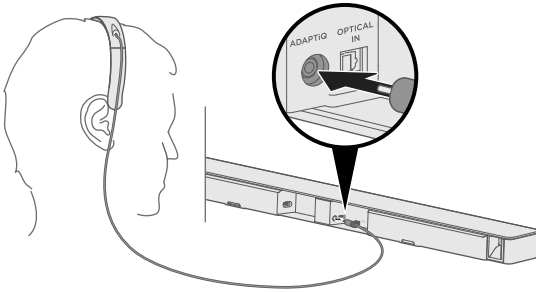

- Put the ADAPTiQ® headset (provided with the SoundTouch® 300) on your head.

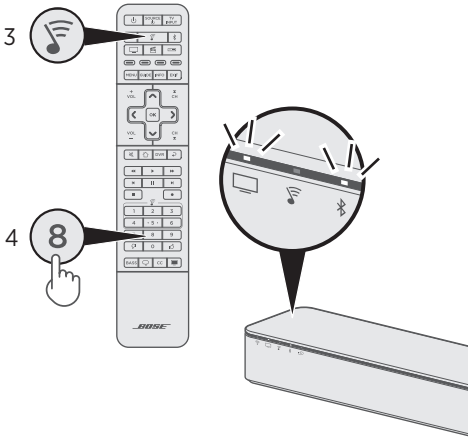

- On the SoundTouch® 300 remote control, press the SoundTouch® button .
- Press and hold **8** until the TV indicator  and the *Bluetooth*® indicator  on the soundbar glow green.



The ADAPTiQ process begins.

Note: If you don't hear your language, press  and  on the remote's navigation pad. To reset the language, press and hold **8** for 10 seconds.

- Follow the voice prompts until the ADAPTiQ process is complete.

If you hear an error message and are unable to complete the ADAPTiQ audio calibration, see page 19.

- Unplug the ADAPTiQ headset from the soundbar and store it in a safe place.

If you later pair the optional bass module, move or mount the system, or move any furniture, run the ADAPTiQ audio calibration again to ensure optimal sound quality.

System status indicators

The front of the wireless receiver has an LED indicator that shows system status. The LED glows according to system state.

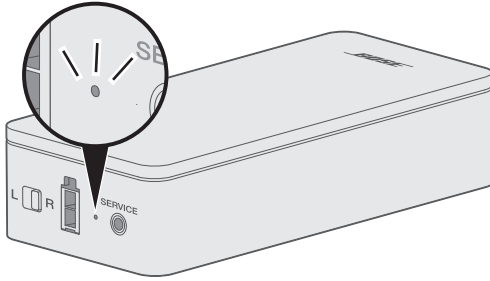

Indicator activity	System state
Blinking amber	Ready to pair
Solid white	Connected to the soundbar
Solid amber (dim)	Disconnected from the soundbar
Blinking white	Downloading system software update
Blinking red	Firmware error — contact Bose® customer service

Cleaning

- Clean the exterior of the rear speakers with a soft, dry cloth.
- Do not use any sprays near the rear speakers. Do not use any solvents, chemicals or cleaning solutions containing alcohol, ammonia or abrasives.
- Do not allow liquids to spill or objects to drop into any openings.

Customer service

For additional help using the rear speakers:

- Visit global.bose.com/Support/VI300
- Contact Bose® customer service.

Limited warranty information

Your system is covered by a limited warranty. Details of the limited warranty are provided on the warranty card in the carton. Please refer to the warranty card for instructions on how to register. Failure to register will not affect your limited warranty rights.

The warranty information provided with this product does not apply in Australia and New Zealand. See our website at www.bose.com.au/warranty or www.bose.com.nz/warranty for details of the Australia and New Zealand warranty.

Technical information

Input power rating: 100 – 240V ~ 50/60Hz 30W

SERVICE connector

The SERVICE connector is for service use only. Do not insert any cables into this connector.

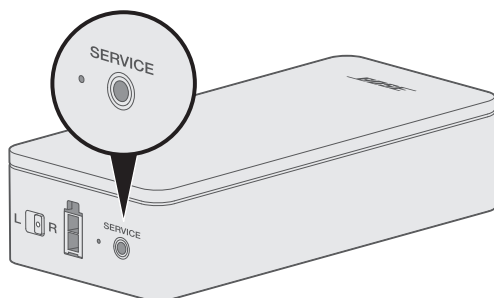

If you experience problems with your rear speakers do the following:

- Unplug the power cords for the wireless receivers, wait 15 seconds and plug them firmly into a live AC (mains) outlet.
- Secure all cables.
- Check the state of system status indicator (see page 14).
- Move the speakers and wireless receivers away from possible interference (wireless routers, cordless phones, televisions, microwaves, etc.).
- Place wireless receivers and rear speakers according to the placement guidelines (see page 6).





If you could not resolve your issue, see the table below to identify symptoms and solutions to common problems. If you are unable to resolve your issue, contact Bose® customer service.

Common solutions

The following table lists symptoms and possible solutions to common problems.

Symptom	Solution
No power	<ul style="list-style-type: none"> • Make sure that the system is powered on by checking the status indicator (see page 14). • Unplug the power cords for the wireless receivers and soundbar, and plug them firmly into a live AC (mains) outlet. Repeat the pairing process (see page 11). • Use the SoundTouch® 300 remote to power on the soundbar.
Wireless receivers don't pair with the soundbar	<ul style="list-style-type: none"> • Unplug the power cords for the wireless receivers and soundbar, and plug them firmly into a live AC (mains) outlet. Repeat the pairing process (see page 11). • Reset the soundbar (refer to your SoundTouch® 300 owner's guide).

TROUBLESHOOTING

Symptom	Solution
No audio	<ul style="list-style-type: none"> • Unmute the system. • Increase the volume. • Make sure that sound is coming out of your SoundTouch® 300 soundbar (refer to your SoundTouch® 300 owner's guide). • If your source is connected to your TV, select the correct TV input (refer to your SoundTouch® 300 owner's guide). • Unplug the power cords for the wireless receivers and soundbar, and plug them firmly into a live AC (mains) outlet. Repeat the pairing process (see page 11). • Make sure that the positive and negative speaker cable wires are securely inserted into the adapter. Firmly plug the adapters into the speakers. • Make sure one wireless receiver is set to the L (left) channel and the other to the R (right) channel. If both wireless receivers are set to the same channel: <ol style="list-style-type: none"> 1. Unplug both wireless receivers from the AC (mains) outlet. 2. Set one wireless receiver to the L (left) channel and the other to the R (right) channel. 3. Plug both wireless receivers back into an AC (mains) outlet.
Intermittent, poor or distorted sound.	<ul style="list-style-type: none"> • Test different sources if available. • If you have not already completed the ADAPTiQ® audio calibration process, run it now (see page 12). • Make sure that the positive and negative speaker cable wires are securely inserted into the adapter. Firmly plug the adapters into the speakers. • If placing the speakers in a cabinet or on a shelf, position them as close as possible to the front edge of the shelf for optimum acoustic performance. • Update the system software: <ol style="list-style-type: none"> 1. On the SoundTouch® 300 remote control, press the SoundTouch® button . 2. Press and hold the Closed Captioning button CC until the Wi-Fi indicator , TV indicator , SoundTouch® indicator  and <i>Bluetooth</i> indicator  on the soundbar blink white. <p>Note: The update may take 10 or more minutes.</p>

Symptom	Solution
No surround sound	<ul style="list-style-type: none"> • Make sure that your TV can output surround sound audio (refer to your TV owner's guide). • Make sure that the positive and negative speaker cable wires are securely inserted into the adapter. Firmly plug the adapters into the speakers. • Make sure one wireless receiver is set to the L (left) channel and the other to the R (right) channel. If both wireless receivers are set to the same channel: <ol style="list-style-type: none"> 1. Unplug both wireless receivers from the AC (mains) outlet. 2. Set one wireless receiver to the L (left) channel and the other to the R (right) channel. 3. Plug both wireless receivers back into an AC (mains) outlet.

Unable to complete ADAPTiQ® audio calibration

Listen to the voice prompts for the following error messages:

Error message	Problem	What to do
1	The microphone on the ADAPTiQ® headset cannot detect sound.	<ul style="list-style-type: none"> • Secure all speaker cables. • Make sure the microphone opening on the top of ADAPTiQ headset is not blocked. • Your ADAPTiQ headset may be damaged. Contact Bose® customer service for replacement parts.
2	The room is too loud.	Re-run ADAPTiQ audio calibration when the room is quiet.
3	The ADAPTiQ headset is too close to the speakers.	Move the ADAPTiQ headset farther away from the speakers.
4	The listening locations are too similar.	Move 1 – 2 ft. (.3 – .6 m) away from your previous listening location.
5	The ADAPTiQ headset cannot take measurements due to movement.	Hold your head still.

After correcting your problem, you must re-run ADAPTiQ audio calibration (see page 12). If you hear a different error message, contact Bose® customer service for further instructions.



772083-0010

BOSE

©2017 Bose Corporation, The Mountain,
Framingham, MA 01701-9168 USA
AM772083 Rev. 03