

BOSE[®]



LIFESTYLE[®] 535/525 series II
home entertainment systems

LIFESTYLE[®] 520/510
home theater systems

Setup Guide | คู่มือการติดตั้ง | 설치 안내서 | 安裝指南 | 安裝指南 | دليل الاعداد

Safety Information

Please read this guide

Please take the time to follow the instructions in this owner's guide carefully. It will help you set up and operate your system properly and enjoy its advanced features. Please save this guide for future reference.

All Bose® products must be used in accordance with local, state, federal, and industry regulations.

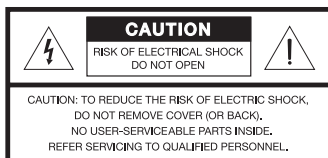

The lightning flash with arrowhead symbol within an equilateral triangle alerts the user to the presence of uninsulated, dangerous voltage within the system enclosure that may be of sufficient magnitude to constitute a risk of electric shock.



The exclamation point within an equilateral triangle, as marked on the system, is intended to alert the user to the presence of important operating and maintenance instructions in this owner's guide.



WARNING: Contains small parts which may be a choking hazard. Not suitable for children under age 3.



WARNINGS:

- To reduce the risk of fire or electrical shock, do not expose the product to rain or moisture.
- Do not expose this apparatus to dripping or splashing, and do not place objects filled with liquids, such as vases, on or near the apparatus. As with any electronic products, use care not to spill liquids into any part of the system. Liquids can cause a failure and/or a fire hazard.
- To prevent electric shock, match the wide blade of the line cord plug to the wide slot of the AC (mains) receptacle. Insert fully.
- Do not place any naked flame sources, such as lighted candles, on or near the apparatus.



CAUTIONS:

- Make no modifications to the system or accessories. Unauthorized alterations may compromise safety, regulatory compliance, and system performance.
- Long-term exposure to loud music may cause hearing damage. It is best to avoid extreme volume when using headphones, especially for extended periods.

The terms HDMI and the HDMI Logo are trademarks or registered trademarks of HDMI Licensing LLC in the United States and other countries.

©2013 Bose Corporation. No part of this work may be reproduced, modified, distributed, or otherwise used without written permission.

Safety Information

NOTES:

- The product label is located on the bottom or the back of the product.
- Where the mains plug or appliance coupler is used as the disconnect device, such disconnect device shall remain readily operable.
- The product must be used indoors. It is neither designed nor tested for use outdoors, in recreation vehicles, or on boats.
- This product is intended to be used only with the power supply provided.
- The speaker wire and interconnect cables included with the system are not approved for in-wall installation. Please check your local building codes for the correct type of wire and cable required for in-wall installation.



Please dispose of used batteries properly, following any local regulations. Do not incinerate.

廢電池請回收



Bose® Corporation hereby declares that this product is in compliance with the essential requirements and other relevant provisions of Directive 1999/5/EC and all other applicable EU directive requirements. The complete declaration of conformity can be found at: www.Bose.com/compliance.

Names and Contents of Toxic or Hazardous Substances or Elements

Part Name	Toxic or Hazardous Substances and Elements					
	Lead (Pb)	Mercury (Hg)	Cadmium (Cd)	Hexavalent (CR(VI))	Polybrominated Biphenyl (PBB)	Polybrominated diphenylether (PBDE)
PCBs	X	0	0	0	0	0
Metal parts	X	0	0	0	0	0
Plastic parts	0	0	0	0	0	0
Speakers	X	0	0	0	0	0
Cables	X	0	0	0	0	0

0: Indicates that this toxic or hazardous substance contained in all of the homogeneous materials for this part is below the limit requirement in SJ/T 11363-2006.

X: Indicates that this toxic or hazardous substance contained in at least one of the homogeneous materials used for this part is above the limit requirement in SJ/T 11363-2006.

Please complete and retain for your records.

The serial and model numbers can be found on the bottom panel of the product.

Lifestyle® model: _____

Control console serial number: _____

Acoustimass® serial number: _____

Speaker array serial number: _____

Purchase date: _____

Please keep your receipt together with this Setup Guide and the Operating Guide.

Safety Information

Important Safety Instructions

1. Read these instructions.
2. Keep these instructions.
3. Heed all warnings.
4. Follow all instructions.
5. Do not use this apparatus near water.
6. Clean only with a dry cloth.
7. Do not block any ventilation openings. Install in accordance with the manufacturer's instructions.
8. Do not install near any heat sources such as radiators, heat registers, stoves, or other apparatus (including amplifiers) that produce heat.
9. Do not defeat the safety purpose of the polarized or grounding-type plug. A polarized plug has two blades with one wider than the other. A grounding type plug has two blades and a third grounding prong. The wide blade or the third prong are provided for your safety. If the provided plug does not fit into your outlet, consult an electrician for replacement of the obsolete outlet.
10. Protect the power cord from being walked on or pinched particularly at plugs, convenience receptacles, and the point where they exit from the apparatus.
11. Only use attachments/accessories specified by the manufacturer.
12.  Use only with the cart, stand, tripod, bracket, or table specified by the manufacturer, or sold with the apparatus. When a cart is used, use caution when moving the cart/apparatus combination to avoid injury from tip-over
13. Unplug this apparatus during lightning storms or when unused for long periods of time.
14. Refer all servicing to qualified personnel. Servicing is required when the apparatus has been damaged in a way, such as power-supply cord or plug is damaged, liquid has been spilled or objects have fallen into the apparatus, the apparatus has been exposed to rain or moisture, does not operate normally, or has been dropped.

Additional safety information

See the additional instructions on the Important Safety Instructions sheet (North America only) enclosed in the shipping carton.

Welcome

Thank You.....	6
Unpacking.....	6

System Setup

Control console box.....	7
Acoustimass® module box.....	10
Speaker box.....	12
Interactive box.....	17
Other Box 4 items.....	19
Applying rubber feet.....	20
If you have setup problems.....	21
Contacting customer service.....	21

Welcome

Thank You

Thank you for choosing a Bose® LIFESTYLE® system for your home. This guide provides step-by-step instructions for setting up your new system. There are two phases to the setup process:

Physical setup phase: Placing the system components and connecting them together.

Interactive setup phase: Completing your setup following the interactive steps on your TV screen provided by the UNIFY® intelligent integration system.

Unpacking

The parts of your new system are packaged in four numbered boxes plus a small box containing the appropriate power cords:

- **1** Control console box
- **2** Acoustimass® module box
- **3** Speaker box
- **4** Interactive box
-  Power cord box (used with boxes 1 and 2)

Starting with Box 1, unpack each box and set up its contents before unpacking the next one.

Be sure to save all of the packing materials. These provide the safest means for any necessary shipping or transporting.

If any part appears damaged, do not attempt to use it. Notify Bose or your authorized Bose dealer immediately. For Bose contact information, refer to the address sheet included in Box 4.

1 Control console box

What you need from box 1:

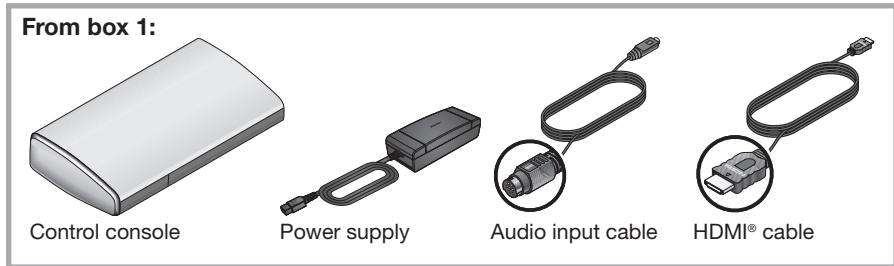

What you need from the power cord box:

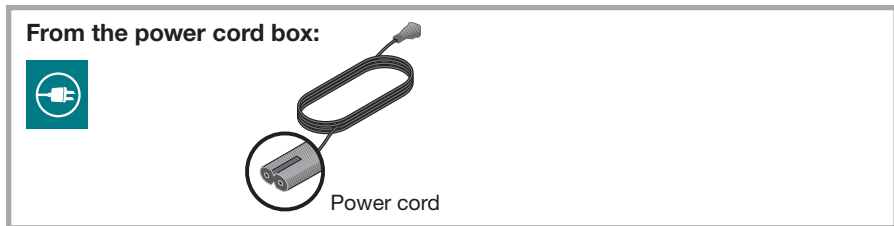

A. Place the control console on a flat, stable surface near your TV.

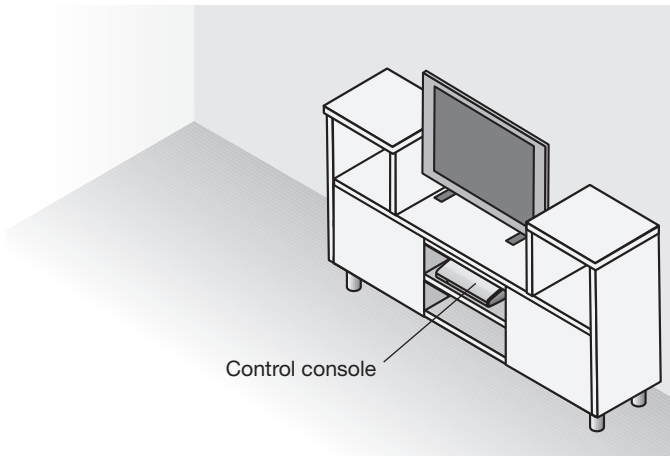

Note: Until your system is completely installed, it may be helpful to keep the control console positioned for easy access to its rear connection panel.

System Setup

- B. Plug one end of the HDMI® cable into an HDMI INPUT connector on your TV. If an HDMI cable is already connected to an HDMI input on your TV, you can use this one. Just disconnect the other end.

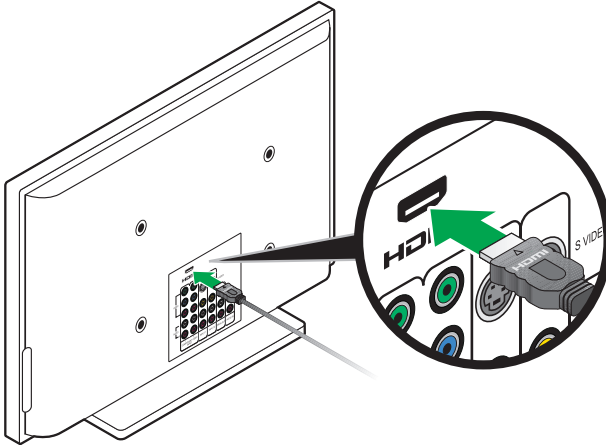

- C. Plug the other end of the HDMI cable you are using into the connector labeled **HDMI OUT Video to TV** on the control console.

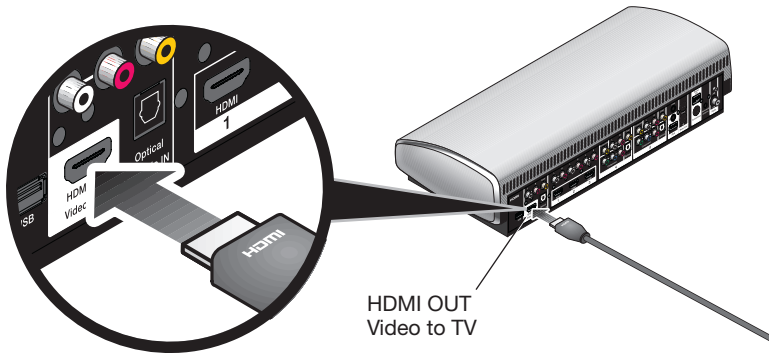

System Setup

- D. Plug one end of the audio input cable into the control console connector labeled **Audio OUT**. Make sure the flat surface with the arrow on the plug faces up.

Leave the other end of the cable on the floor. You will be asked to connect it while setting up the contents of the next box.

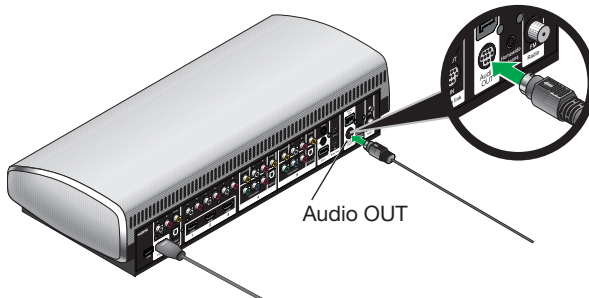

- E. Plug the power supply output cord into the control console **Power** connector.

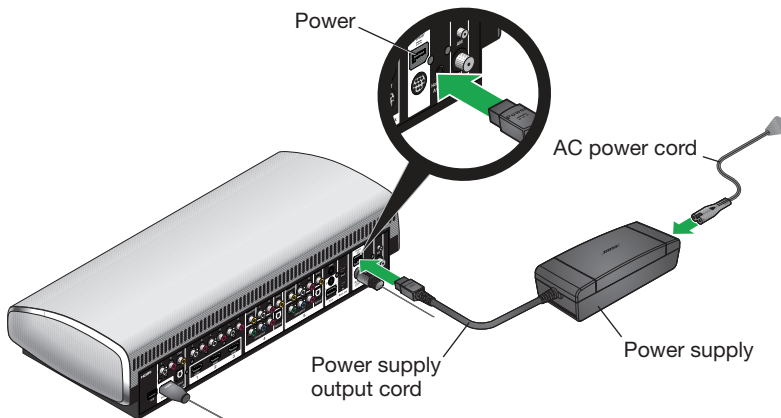

- F. Remove a power cord from the power cord box.



- G. Plug one end of the power cord into the power supply. *Make sure you push the plug in as far as it can go.*
- H. Plug the other end of the power cord into a live AC (mains) power outlet.
- I. Continue with Box **2** on the next page.

System Setup

2 Acoustimass® module box

What you need for the following steps:

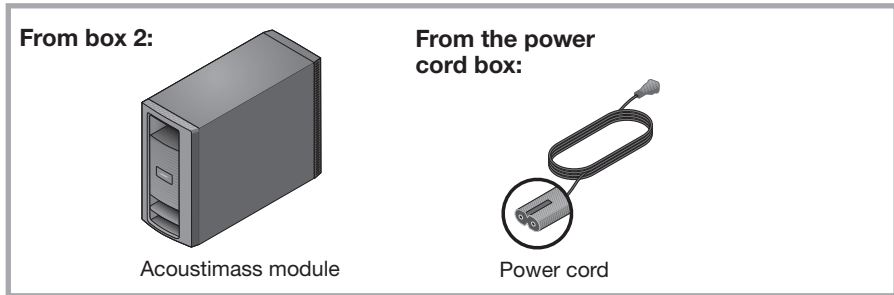

- A.** Place the Acoustimass module on the floor at the same end of the room as the TV. Make sure there is a live AC (mains) power outlet nearby.

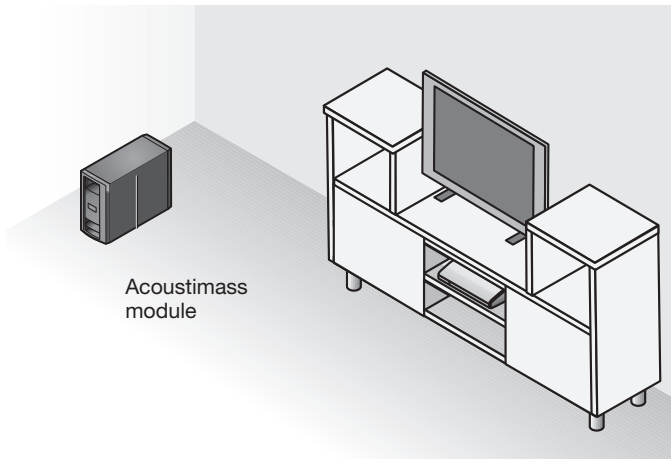

- B.** Lay the module on its side and locate the connector panel.

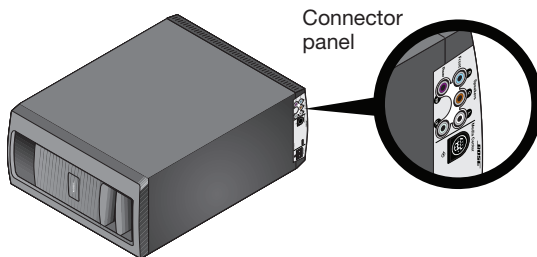

System Setup

CAUTION: DO NOT stand the Acoustimass® module on its front or back end.

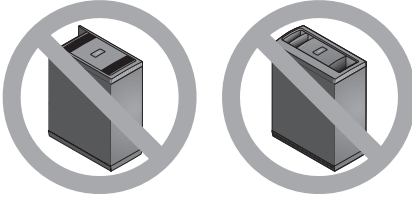

- C. Plug the free end of the audio input cable into the **Media Center** connector on the Acoustimass module.

Make sure the flat surface with the arrow faces the front of the module.

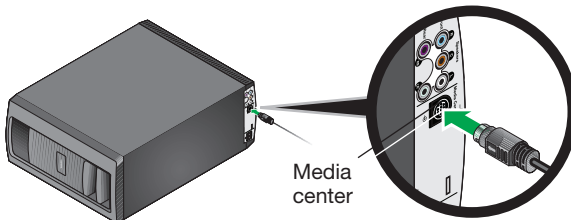

- D. Remove a power cord from the power cord box.



- E. Plug one end of the power cord into the **AC Power** connector on the Acoustimass module. Make sure you push the plug in as far as it can go.

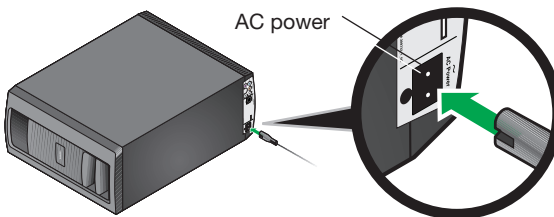



- F. Plug the other end of the power cord into a live AC (mains) power outlet.
G. Continue with Box **3** on the next page.

System Setup

3 Speaker box

What you need for the following steps:

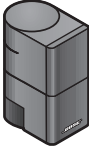
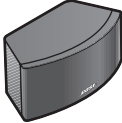
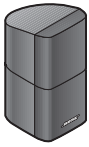
System speakers (one set of the three types shown)

Jewel Cube® speakers	
 (4) Left or right, front or rear speaker	 (1) Center front speaker
Direct/Reflecting® cube speaker arrays	
 (4) Left or right, front or rear speaker	 (1) Center front speaker
Virtually Invisible® single cube speakers	
 (5) Left or right, front or rear, and center front speaker	

Front speaker cables



Left front (L) White



Center front (C) Brown



Right front (R) Light blue

Rear speaker cables

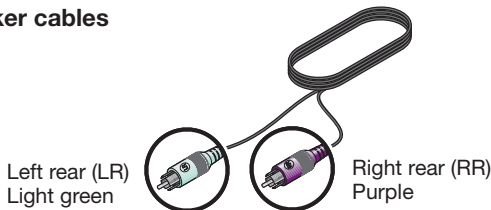

Left rear (LR)
Light green

Right rear (RR)
Purple

Note: You can place system speakers on wall brackets or floor stands. To purchase these accessories, contact your local Bose® dealer or visit www.Bose.com.

System Setup

- A.** Place the center front speaker on a stable and level surface directly above or below the center of your TV screen as in the following example.

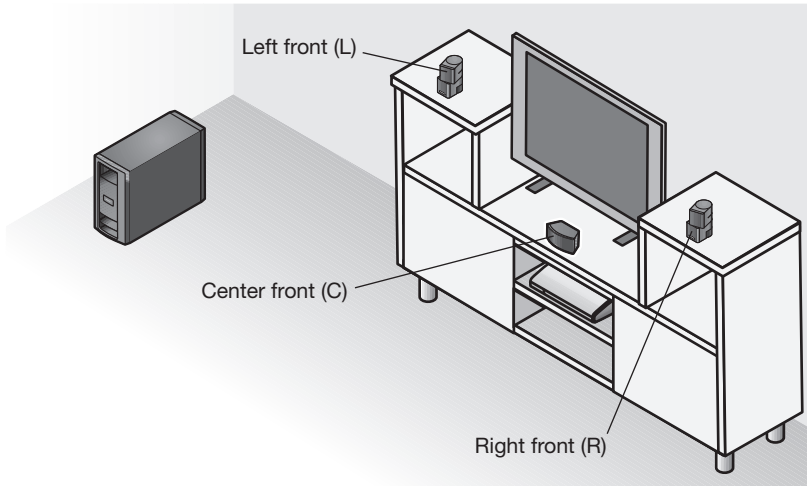

- B.** Place one speaker to the left and one to the right of the TV.
- Keep each speaker within 3 ft (1 m) of the TV screen to prevent too much separation of the sound from the picture. Vary this distance to suit your room conditions and personal preference.
 - If placing the speakers in an enclosed bookcase shelf, position them at the front edge of the shelf.
 - Rotate the cubes so that one cube of each speaker points forward into the room and the other points at a side wall to create reflected sound.

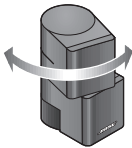

System Setup

- C. Place the rear speakers toward the back of the room behind the viewers at ear height (when seated) or higher, if possible.

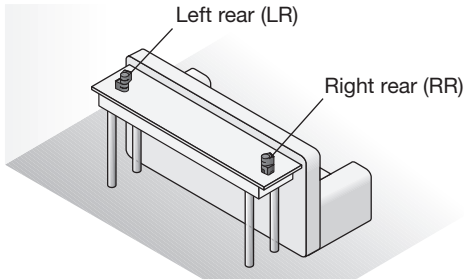

- Make sure the 50 ft (15.2 m) rear speaker cables will reach from the speakers to the Acoustimass® module.
- Aim the speakers away from the listeners to prevent them from pinpointing the exact location of the sound source.
- Rotate the cubes so that one cube of each speaker points forward into the room and the other points at a side wall to create reflected sound.

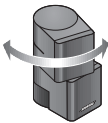

- D. Locate the colored connectors on the bottom panel of the Acoustimass® module.

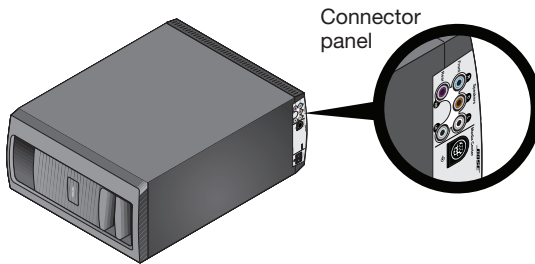

- E. Plug the speaker cables into the Acoustimass module connectors. Be sure to match each cable plug to each connector by the color code.

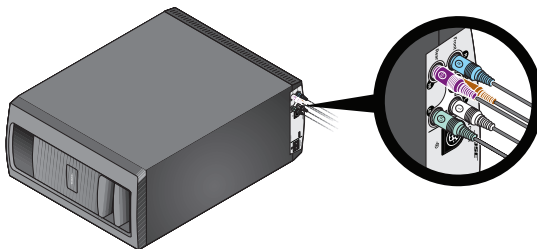

System Setup

- F. Locate the speaker position markings on the free ends of the speaker cables.

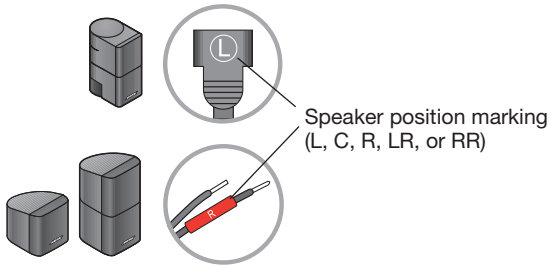

- G. Using the speaker position markings, run each cable out to its respective speaker as in the following setup example of a room.

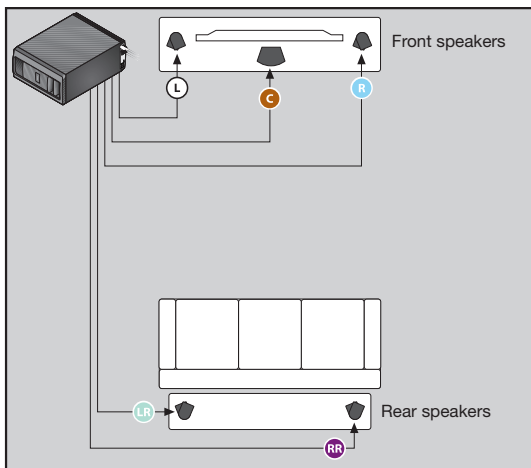

System Setup

H. Connect the speaker cable to the type of speaker you have.

For Jewel Cube® speakers:

Insert the plug into the speaker connector.

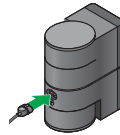

For Direct/Reflecting® and Virtually Invisible® single cube speakers:

Press the button and insert the wires. Connect the red-collared wire to the red connector. Connect the other wire to the black connector.



Notes:

- The rear speaker cables for Direct/Reflecting® and Virtually Invisible® single cube speakers are webbed together. You can pull them apart as needed.
- Put the Acoustimass® module in its final position:
 - Upright (BEST) or on either side (ALTERNATE).

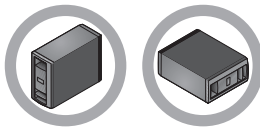

- With the front opening facing into the room.
- At least 18 in (45 cm) from any TV to avoid magnetic interference with the TV image. Move it farther away if you still notice interference.

CAUTION:

- Do not put electronic media, such as video or audio tapes, on or next to the Acoustimass® module for long periods of time. The magnetic field surrounding the module may erase some or all of the recorded material.
- DO NOT BLOCK the ventilation openings on the module. This can cause it to overheat.

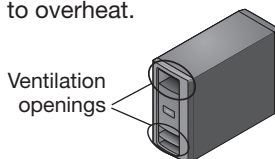

I. *Congratulations!* At this point you have set up the control console, the Acoustimass® module, and the speakers. You are now ready to turn on your system and enter the interactive phase of the setup process using the UNIFY® intelligent integration system.

Continue with Box **4** on the next page.

4 Interactive box

What you need for the following steps:

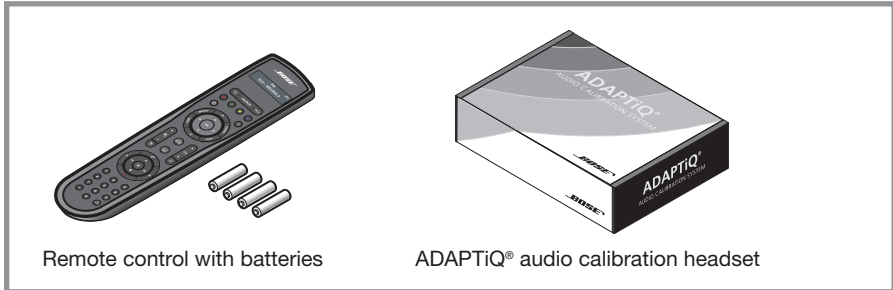

IMPORTANT!

Before you start, make sure your speakers and Acoustimass® module are in their final positions.

Do not connect any devices to the control console at this time. The instructions provided on your TV will tell you when to do this.

- A.** Slide the battery compartment cover off the back of the remote control.

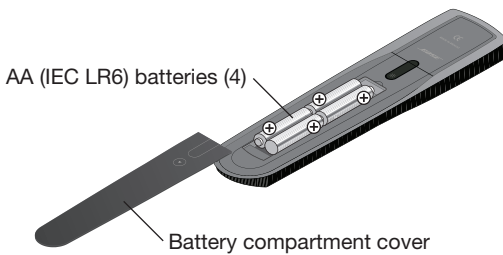

- B.** Install four AA (IEC LR6) batteries, matching the polarity markings (+ and -) to the markings inside the battery compartment.
- C.** Slide the battery cover back into place.

System Setup

- D.** Press the power button on the control console to turn on your system.

Because the system is in a low power state when in standby, it takes several seconds to start. When the system status indicator changes from blinking to steady green, your system is ready to use.

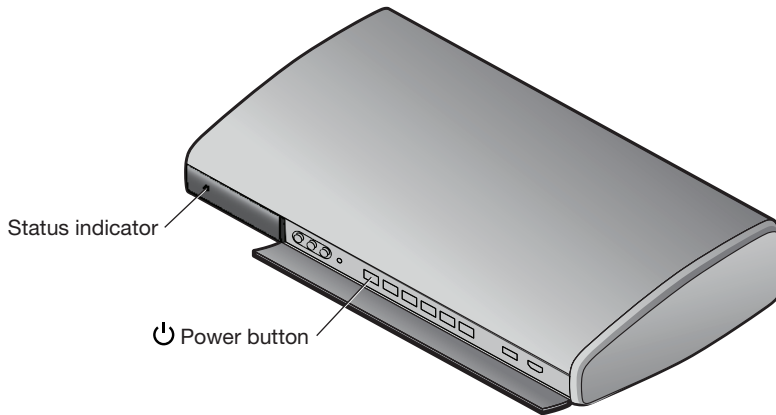

- E.** Turn on your TV.
- F.** Using the remote that came with your TV, change the TV input to the one that is connected to your LIFESTYLE® system.
- G.** Follow the instructions on your TV. You will be prompted to do the following:
- Select your language.
 - Optimize the system audio using the ADAPTiQ® audio calibration system.
 - Connect audio/video devices to the control console.
 - Configure your Bose® remote to control your connected devices.

Other Box 4 items

The remaining items in Box 4 may or may not be required to set up your LIFESTYLE® system. For more information on using these accessories or adding other devices to your system at another time, see the operating guide.

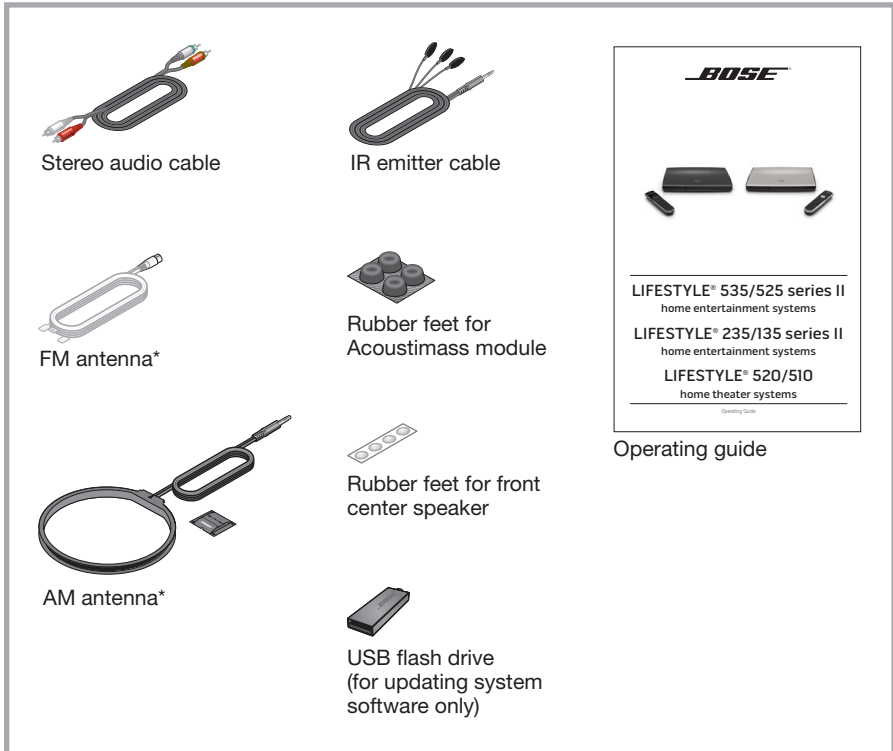

*For LIFESTYLE® 535 and 525 systems only.

System Setup

Applying rubber feet

When placing the Acoustimass® module on bare floors, you can attach the included rubber feet to the bottom of the module for greater stability and to protect your floor.

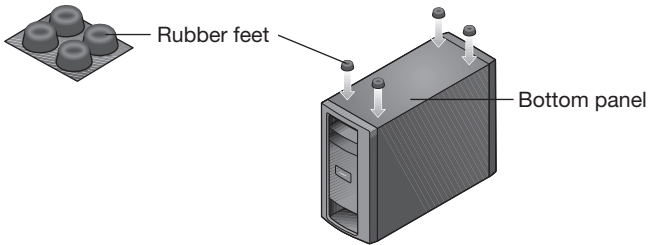

Vibration can cause speakers to move, particularly if placed on a smooth surface like glass or highly polished wood. If you are placing the center speaker on such a surface, you can attach the included rubber feet to the bottom of the speaker for greater stability.

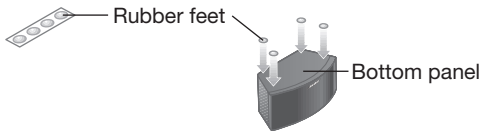

If you have setup problems

If you experience any difficulties during the setup process, such as an unrecognized device remote or a connection error, you can reactivate the interactive setup mode at any time and correct or change part of your system setup. See “Using the Setup Mode” in your system operating guide.

For help in trying to resolve any problems, see the troubleshooting table in your system operating guide.

Contacting customer service

For additional help in solving problems, contact Bose® Customer Service. See the address sheet included in Box 4.



372634-0010

BOSE[®]
Better sound through research[®]

©2013 Bose Corporation, The Mountain,
Framingham, MA 01701-9168 USA
AM372634_00 Rev. 00