

LIFESTYLE[®] DVD

HOME ENTERTAINMENT SYSTEMS

Installation Guide

Guía de instalación



Notice d'installation



SAFETY INFORMATION

Please read this guide

Please take the time to follow the instructions in this guide carefully. It will help you set up and operate your system properly and enjoy all of its advanced features. Please save this guide for future reference.

-  **WARNING:** To reduce the risk of fire or electrical shock, do not expose the product to rain or moisture.
-  **WARNING:** The apparatus shall not be exposed to dripping or splashing, and objects filled with liquids, such as vases, shall not be placed on the apparatus. As with any electronic products, use care not to spill liquids into any part of the system. Liquids can cause a failure and/or a fire hazard.

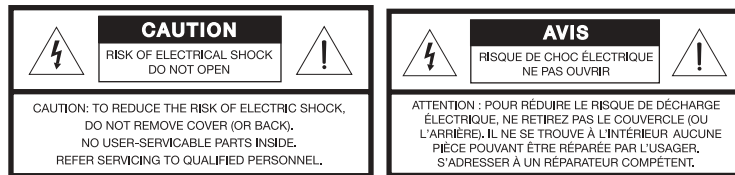

These CAUTION marks are located on your LIFESTYLE® media center and Acoustimass® module enclosures:



The lightning flash with arrowhead symbol within an equilateral triangle alerts the user to the presence of uninsulated, dangerous voltage within the system enclosure that may be of sufficient magnitude to constitute a risk of electrical shock.





The exclamation point within an equilateral triangle, as marked on the system, is intended to alert the user to the presence of important operating and maintenance instructions in this owner's guide.

Class 1 laser product

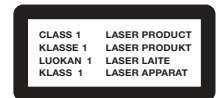
This CD/DVD player is classified as a CLASS 1 LASER PRODUCT according to EN 60825-1:1994+A1+A2, IEC60825-1:1993+A1+A2.



-  **CAUTION:** Use of controls or adjustments or performance of procedures other than those specified herein may result in hazardous radiation exposure. The compact disc player should not be adjusted or repaired by anyone except properly qualified service personnel.
-  **CAUTION:** Make no modifications to the system or accessories. Unauthorized alterations may compromise safety, regulatory compliance, and system performance.
-  **WARNING:** No naked flame sources, such as lighted candles, should be placed on the apparatus.

Class B emissions

This Class B digital apparatus meets all requirements of the Canadian Interference-Causing Equipment Regulations (Canada only).



If applicable, the radio communication device incorporated into this apparatus meets all requirements of the Industry Canada standard RSS-310 (Canada only).



This product conforms to the EMC Directive 89/336/EEC and to the Low Voltage Directive 73/23/EEC. The remote control conforms to the RTTE Directive 99/5/EC. The complete Declaration of Conformity can be found at www.bose.com/static/compliance/index.html.



Please dispose of used batteries properly, following any local regulations. Do not incinerate.

-  **Note:** Where the mains plug or appliance coupler is used as the disconnect device, such disconnect device shall remain readily operable.
-  **Note:** The product must be used indoors. It is neither designed nor tested for use outdoors, in recreation vehicles, or on boats.
-  **Note:** This product is intended to be used only with the power supply provided.

Additional safety information

See the additional instructions on the **Important Safety Information** sheet enclosed in the shipping carton.

CONTENTS

	INTRODUCTION	5
	SYSTEM PLACEMENT	8
	BASIC SYSTEM CONNECTIONS	12
	OPTIONAL CONNECTIONS AND ADDITIONS	26
	REFERENCE	39
INTRODUCTION		5
Before you begin		5
Using this guide for your setup		5
Getting additional assistance		5
Unpacking the carton		6
System parts		6
Supplied cables and accessories		7
SYSTEM PLACEMENT		8
Positioning your media center		8
Placing the five cube speakers around your room		8
Deciding where you want the center speaker		9
Arranging the left and right front speakers		9
Positions for the two rear speakers		10
Choosing a location for the Acoustimass® module		10
Hearing the results of proper placement		11
BASIC SYSTEM CONNECTIONS		12
Connecting speaker cables to the module		12
Connecting the Jewel Cube® speakers		12
Connecting single cube or cube array speakers		13
Connecting the speakers to the module		13
Connecting the module to the media center		15
Adding antennas for radio reception		16
FM antenna		16
AM antenna		16
Cable radio		16
Connecting your TV for viewing DVDs		17
Using a SCART adapter		18
Connecting audio for your TV sound		19
Setting the TV properly is important		20
Completing the system power connections		21
Installing the remote control batteries		22
Making sure the sound is as good as it gets		23
Using System Setup Disc 1		23
Using Disc 2 for ADAPTiQ® audio calibration		23
Taking the next steps		24
Installing the TV on/off sensor		25

OPTIONAL CONNECTIONS AND ADDITIONS	26
Considering higher-quality connections	26
Determining the options for your setup	26
Making other audio connections	26
Choosing digital audio	27
Using advanced video connections	28
Moving beyond composite to S-Video	28
Connecting for progressive scan or HDTV	29
Making these additional video connections	29
VCR connections	30
Cable or satellite box options	31
Connecting a VCR in addition to cable/satellite	32
Connecting a DVR in addition to cable/satellite	33
Component video connections as another option	34
Cables and considerations for further additions	36
Connecting external playback equipment	36
Connecting record/playback equipment	36
Connections for other needs	37
Antenna extender	37
IR emitter cable (supplied)	37
Serial data jack	37
Data port	37
Getting further advice for your components	38
REFERENCE	39
Enjoying your system in other rooms	39
Adding other products	39
Making them all work together	40
Accessories	40
Contacting customer service	41
Limited warranty	41
Technical information	41

For Your Records

Serial numbers are located on the bottom of the media center and the connection panel of the Acoustimass® module.

Your system includes one (circle one): AV 18 Series III; AV 38 Series II; or AV 48 Series II media center
(Identify yours by the label on the bottom)

Serial numbers: Media center: _____ Acoustimass module: _____

Dealer name: _____ Dealer phone: _____ Purchase date: _____

Bose recommends that you keep your sales slip and a copy of your product registration card together with this guide.

**Be sure to fill out your product registration card and mail it to Bose.
Doing so is the only way to ensure that you will receive future software updates by mail.**

Before you begin

Thank you for choosing a Bose® LIFESTYLE® DVD home entertainment system. Superior audio performance for both music and movies places this system at the heart of home theater enjoyment.

Your system also features the proprietary ADAPTiQ® audio calibration system, which tailors system performance so it is optimal in the location you choose. To extend the enjoyment of your system, it also provides connection jacks allowing for expansion in up to 14 other rooms.

Using this guide for your setup

This guide provides information for:

- Selecting locations for the media center, speakers, and Acoustimass® module
- Identifying and connecting the system parts
- Using the provided discs to confirm setup and performance
- Connecting optional audio and video equipment to the system

Your other equipment may include:

- PVR or DVR (a personal or digital video recorder)
- VCR (a video cassette recorder)
- Cable or satellite box
- Game console
- DVD changer
- Recording equipment

For system expansion into other rooms

If you are ready to expand the system sound to other rooms, you may want to familiarize yourself with special considerations for “Enjoying your system in other rooms” on page 39 before you begin making connections.

Getting additional assistance

Bose also provides an online interactive guide and illustrations geared to help with specific system setups. Please visit this website at: owners.bose.com.

 **Note:** *At this time, the website mentioned above is provided in English only.*

For your specific questions or help in assessing a problem, be sure to contact Bose directly. Refer to the address list provided in the carton.

Unpacking the carton

Carefully unpack your system and save all of the packing materials, which provide the safest means for shipping or transporting.

If any product part appears damaged, do not attempt to use it. Notify Bose or your authorized Bose® dealer immediately. For Bose contact information, refer to the address sheet included in the carton.

Note: Now is a good time to locate the serial numbers for your system, on the bottom of the media center and near the connection panel on the Acoustimass® module. For future reference, we suggest that you copy those numbers onto "For Your Records" on page 4.

System parts

Verify that your system includes the following main parts (Figure 1).

Figure 1
System parts

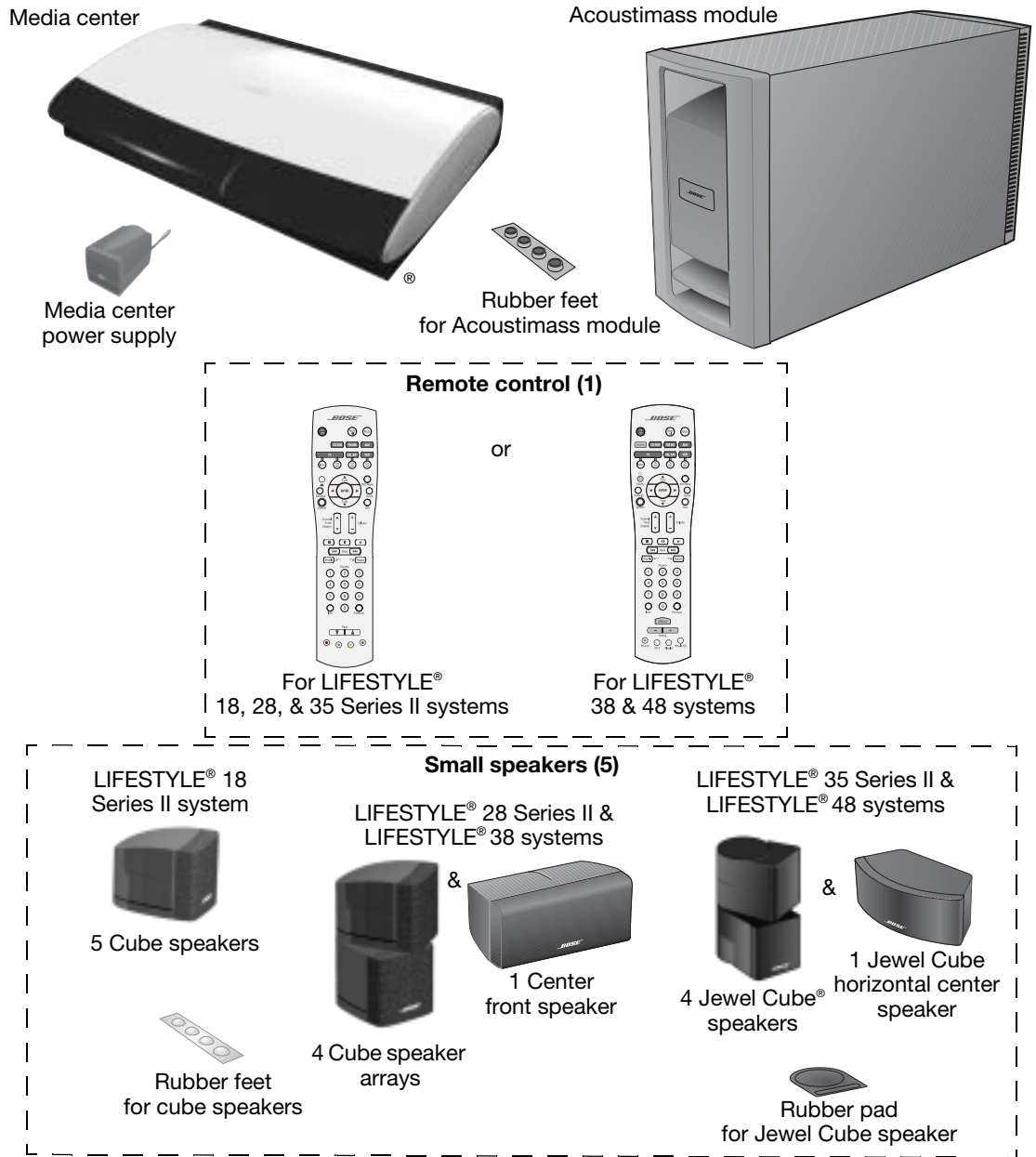

Supplied cables and accessories

Cables needed to get your system operational are supplied. However, you may need others to complete your unique home theater setup as preferred.

Note: Progressive scan, a feature of some TVs, requires using a component video cable, for example.

Figure 2

Supplied cables and accessories

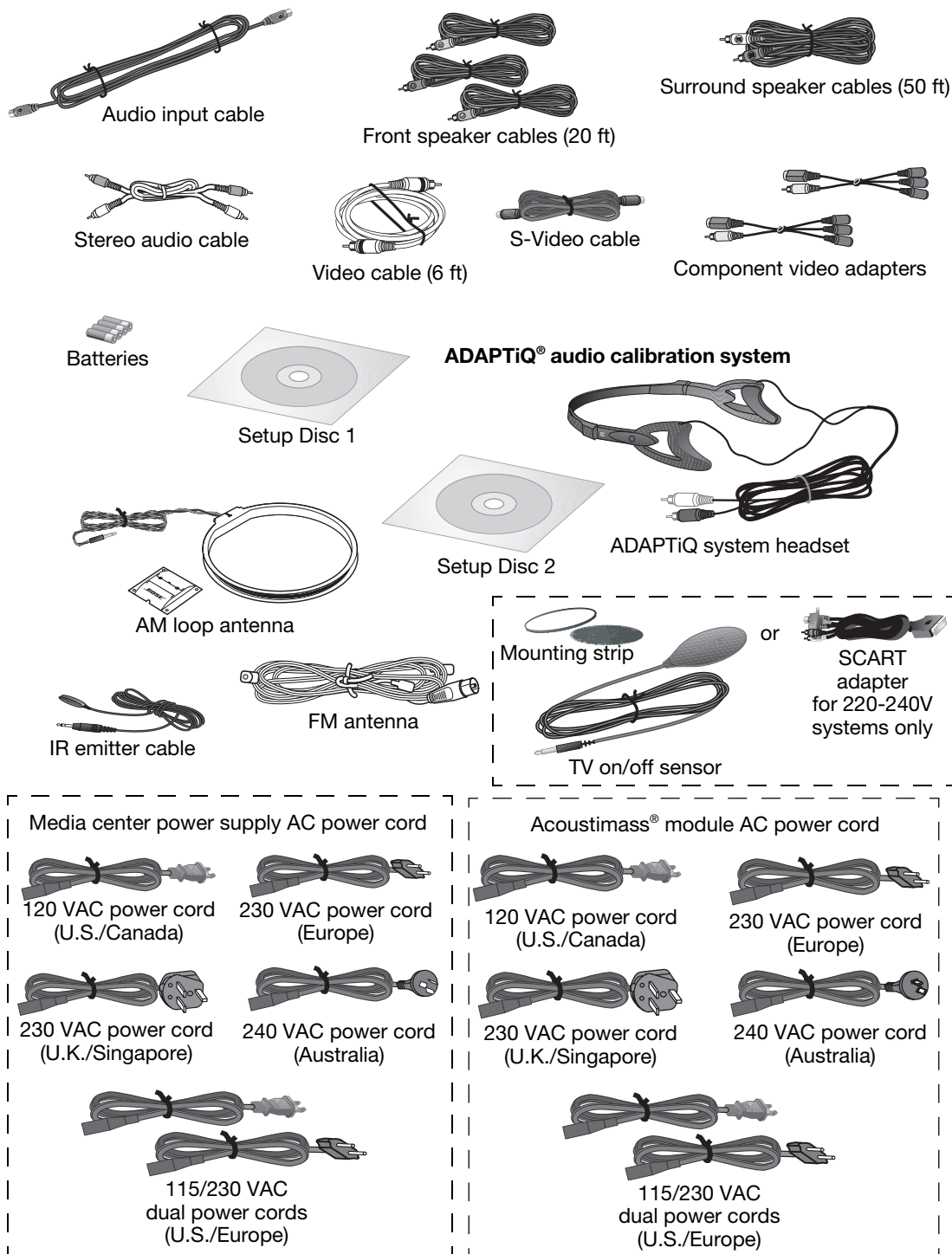

Note: A box with dotted lines identifies parts that vary with different product versions or in different countries.

SYSTEM PLACEMENT

Positioning your media center

To select a location in your room for the media center, use the guidelines below:

- Place the media center close enough to other sound sources (TV, VCR, cable or satellite box), to allow for easy cable connections. Check the length of the audio and video cables you will use for these additional components.

🎵 **Note:** Additional cables are available from your local Bose® dealer. Or, to contact Bose directly, refer to the address list provided in the carton. If you prefer, you can order cables from our website: www.bose.com.

- Do not block the front of the media center. Allow enough room to lift up the front cover and open the CD/DVD tray. Also, be sure you have a clear view of the display window on the front of the media center (Figure 3).
- Place the media center within 30 feet (9.1 meters) of the Acoustimass® module (the length of the audio input cable).

🎵 **Note:** For convenience, until your system is completely installed, you may wish to keep the media center positioned for easy access to its rear connection panel.

Figure 3

Front features of the media center

Front door – Make sure you allow enough room to lift this door.

Display window – Make sure you can see this information while using your system.



Disc tray – Make sure nothing blocks this CD/DVD tray as it slides open.

IR emitter – Make sure nothing impedes it from sending signals to other components in the room.

Placing the five cube speakers around your room

When you place your speakers according to the guidelines that follow, they provide the audio atmosphere of a home theater. If you like, experiment with the placement and orientation of the speakers to produce the sound most pleasing to you.

Bose offers a variety of speaker mounting accessories, including stands and wall brackets. For more information, or to purchase accessories, contact your local Bose dealer or visit www.bose.com. To contact Bose directly, refer to the address list provided in the carton.

⚠️ **CAUTION:** Choose a stable and level surface for each speaker. Vibration can cause speakers to move, particularly on smooth surfaces like marble, glass, or highly polished wood.

Deciding where you want the center speaker

The center speaker sound should seem to come directly from the center of the picture. The provided cable allows it to be up to 20 feet (6.1 meters) from the Acoustimass® module.

1. Place the center speaker in an upright position, directly above or below the center of the TV screen or as close to that as possible.
2. Align the front of the speaker with the front edge of the TV screen.

⚠ CAUTION: Attach the supplied rubber feet (or pad) to its bottom surface before placing a center speaker on top of your TV. This provides stability and prevents shifting from vibration. To obtain additional rubber feet, contact Bose® Customer Service. Refer to the Bose address list included with your system.

Arranging the left and right front speakers

Place one speaker to the left and one to the right of the TV (Figure 4).

- Keep each speaker within 3 feet (1 meter) of the TV screen to prevent too much separation of the sound from the picture. Vary this distance to suit your room conditions and personal preference.
- If any front speakers will be in a bookcase unit, be sure to position them at the front edge of the shelf. Placing them farther back can change the tonal quality of the sound.
- Place the speakers up to 20 feet (6.1 meters) from the Acoustimass module, which is the length of the front speaker cables.
- Rotate the top cube of each speaker array (or the single cube) toward the wall or another hard surface to create reflected sound. For a view of this effect, refer to Figure 5 on page 10.

Figure 4

Recommended speaker locations

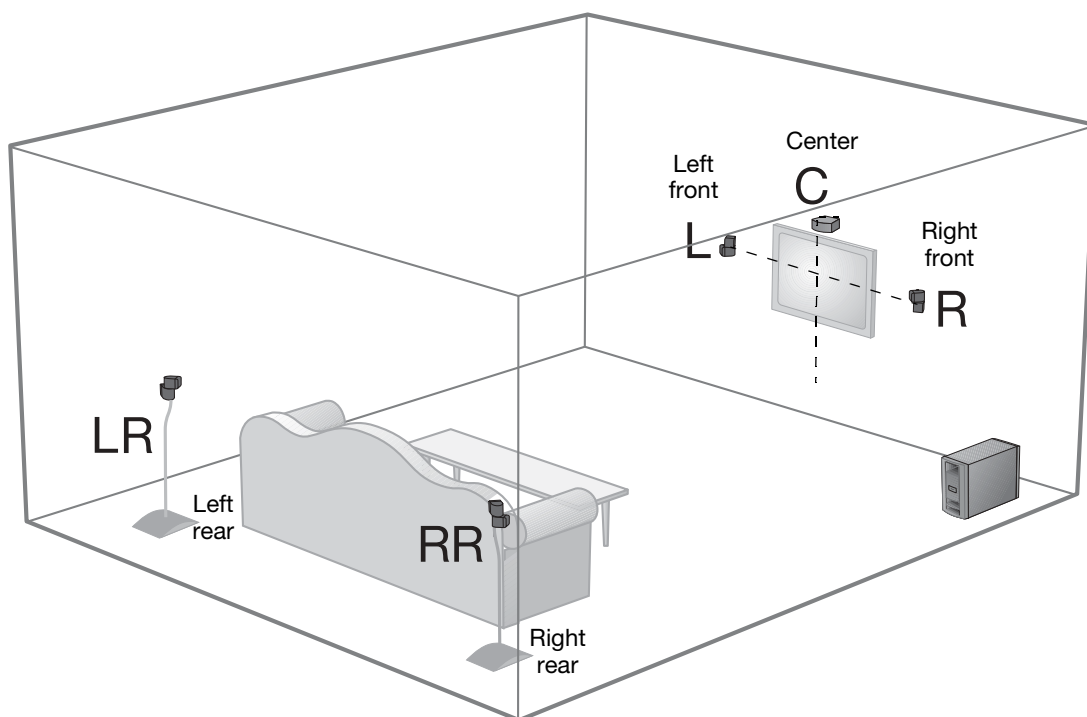

Positions for the two rear speakers

The placement goal for rear surround speakers is to create an area of sound around the listener. By locating them in the back half of your room and directing the cubes away from the listeners, you prevent them from pinpointing the exact location of the sound source, which is ideal.

The surround speaker cables allow for up to 50 feet (15.2 meters) from the Acoustimass® module.

1. Place the speakers at ear height (when seated) or higher, if possible. The longer the path from speakers to ears, the better.
2. Adjust one cube of each speaker to reflect sound off one or more surfaces.

Choosing a location for the Acoustimass® module

While choosing the best place in your room (Figure 4 on page 9), try to keep the module:

- Along the same wall as the TV or at the same end of the room as the front speakers.
- Within the reach of:
 - The media center, using the 30-ft (9.1 m) audio input cable.
 - The front and center speakers, using the three 20-ft (6.1 m) speaker cables, and the two rear speakers using the 50-ft (15 m) speaker cables.
 - An AC power (mains) outlet.
- At least 18 inches (45 centimeters) from the TV to avoid magnetically interfering with the TV image. Move it farther away if you still notice interference.
- Positioned with its grille (with a Bose® logo) facing into the room or perpendicular to the closest wall. This prevents the wall from blocking sound output or boosting the bass.
- Off-center between two walls or between a floor and ceiling.
- Set on its side, top, or bottom, but NOT standing on either end (Figure 5).

CAUTION: Do not block the ventilation slots on the module.

Figure 5

Proper and improper positioning of an Acoustimass module

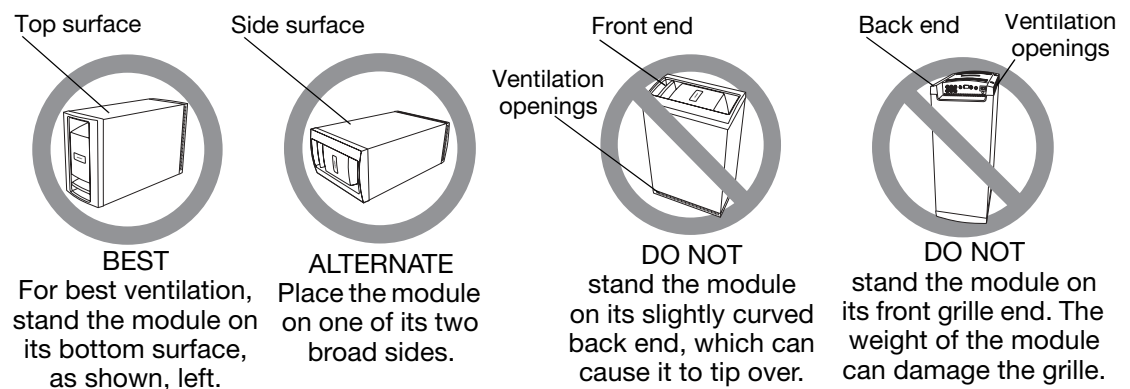

- Under a table or behind a cabinet, for convenience. However, not where furniture or drapes block any openings on the module.
- With four self-adhesive rubber feet attached to the surface that touches the floor, for added stability and protection from scratches.
- Where it will not expose electronic media like tapes to its magnetic field for long periods.

Hearing the results of proper placement

Placing your speakers properly is the first step to getting the full, rich, Bose® quality sound this system is designed to provide (Figure 6).

Figure 6

Results of proper Jewel Cube® or cube speaker array placement

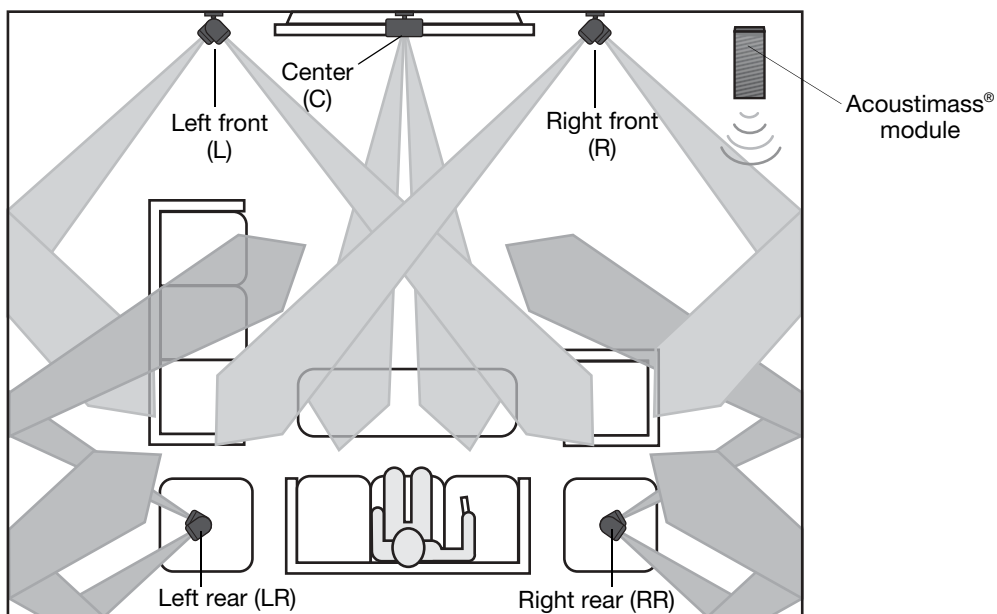
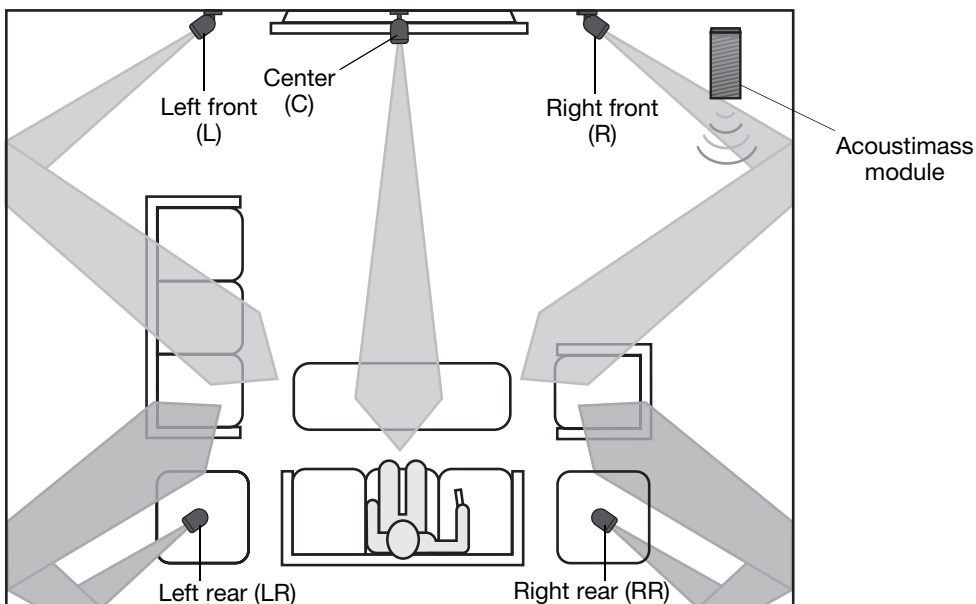

Figure 7

Results of proper single cube speaker placement



For further validation of your setup you can rely on the two discs provided with the system. Disc 1 helps verify placement of the speakers, while Disc 2 walks you through use of the ADAPTiQ® audio calibration system. Its custom equalization adjusts the audio to compensate for room furnishings, speaker placement, and the location of listeners in your room.

BASIC SYSTEM CONNECTIONS

Connecting speaker cables to the module

Your LIFESTYLE® DVD system includes five small speakers. The type of speakers in your system determines how the supplied cables connect to them.

- For Jewel Cube® speakers, follow the instructions below.
- For single cube or cube array speakers, follow the instructions on page 13.



Jewel Cube speaker



Jewel Cube horizontal center speaker

Connecting the Jewel Cube® speakers

The supplied cables feature a plug-in connector that ensures proper polarity (+ to + and - to -) connections.

- Use the supplied 20-ft (6.1 m) cables for the three front speakers.
- Use the supplied 50-ft (15.2 m) cables for the speakers at the rear of your room. After running these cables to the rear of your room, you can unzip them by simply pulling them apart. This makes it is easy to reach each of the rear speakers.

To make the connections:

1. Notice the marking on each cable plug and match it to the speaker in that location:
 - *Front speaker cable plugs* have L (left), R (right), and C (center) markings.
 - *Rear speaker cable plugs* have LR (left rear) and RR (right rear) markings.
2. Orient the plug with its small knob up, so the plug slips easily into a notch on top of the jack on the back of each speaker (Figure 8).
3. Insert the plug fully into the jack on the rear of its respective speaker. For example, the plug marked L connects to the speaker at the left front of your room.

Figure 8

Plug-in connections to these speakers

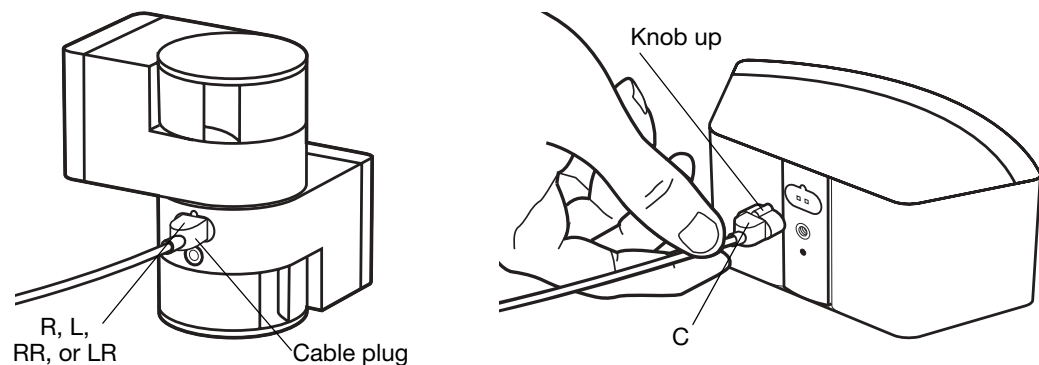

4. Follow the instructions on page 13 to connect each cable to the corresponding jack on the Acoustimass® module.

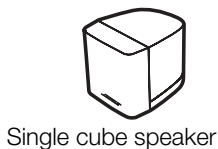
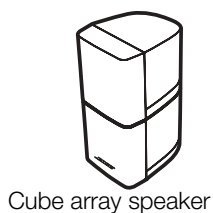

Connecting single cube or cube array speakers

These speakers feature red and white connection terminals on the back of each speaker. Be sure to match the red-collared wire to the red terminal, to maintain positive-to-positive (+ to +) connections.

- Use the supplied 20-ft (6.1 m) cables for the three front speakers.
- Use the supplied 50-ft (15.2 m) cables for the speakers at the rear of your room. After running these cables to the rear of your room, you can pull them apart to reach each of the rear speakers.
- To make the connections:
 1. Notice a label on each red-collared wire that matches it to the proper speaker (Figure 9a).
 - L for the speaker at the left front
 - LR for the speaker at the left rear
 - C for the speaker at the center front
 - RR for the speaker at the right rear
 - R for the speaker at the right front
 2. Press the terminal tab to insert each wire into the proper jack (Figure 9b).

Figure 9

Making the connection to (a) a single cube or cube array speaker and (b) to a center speaker (not provided in all systems)

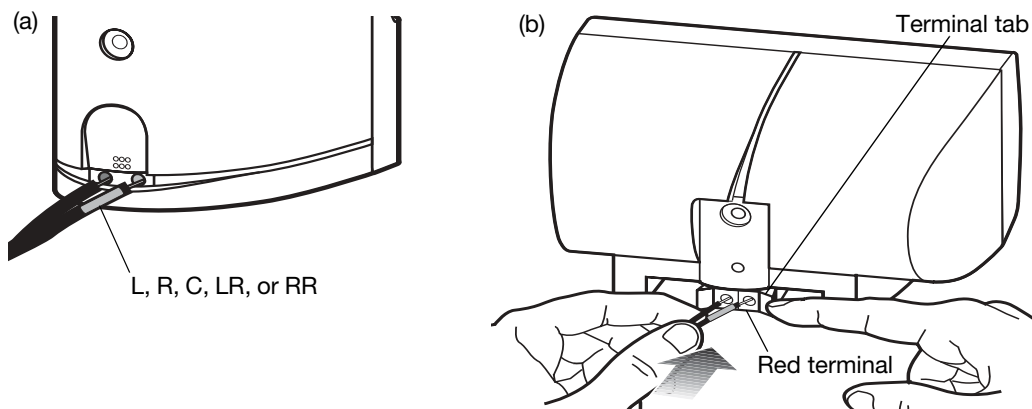

3. Follow the instructions below to connect each cable to the corresponding jack on the Acoustimass® module.

Connecting the speakers to the module

You may find it convenient to temporarily turn the module upside down while making these connections. Then, be sure to place the module on its side or bottom surface when the connections are completed.

⚠ CAUTION: Before you make these connections, be sure that the media center and the Acoustimass module are NOT yet connected to an AC (mains) power outlet.

To make these connections:

1. Use the colors and labels on the RCA connectors at the free end of each speaker cable as guides in connecting to the module. For a color reference, you may want to use the *Quick Setup Guide* provided in the carton.

BASIC SYSTEM CONNECTIONS

2. Connect the front speaker cables as follows (Figure 10):
 - *White connector labeled L* goes into the white jack labeled Front L.
 - *Light blue connector labeled R* goes into the light blue jack labeled Front R.
 - *Brown connector labeled C* goes into the brown jack labeled Front C.
3. Connect the rear speaker cables as follows:
 - *Light green connector labeled LR* goes into the light green jack labeled Rear LR.
 - *Purple connector labeled RR* goes into the purple jack labeled Rear RR.

🎵 **Note:** To lengthen speaker cables, as needed, you can splice in 18-gauge or thicker cord (connecting + to + and - to -). Or, you can order heavy-duty speaker extension cable from Bose. To contact Bose directly, refer to the address list provided in the carton.

Figure 10

Matching connector markings to those on the Acoustimass® module jacks

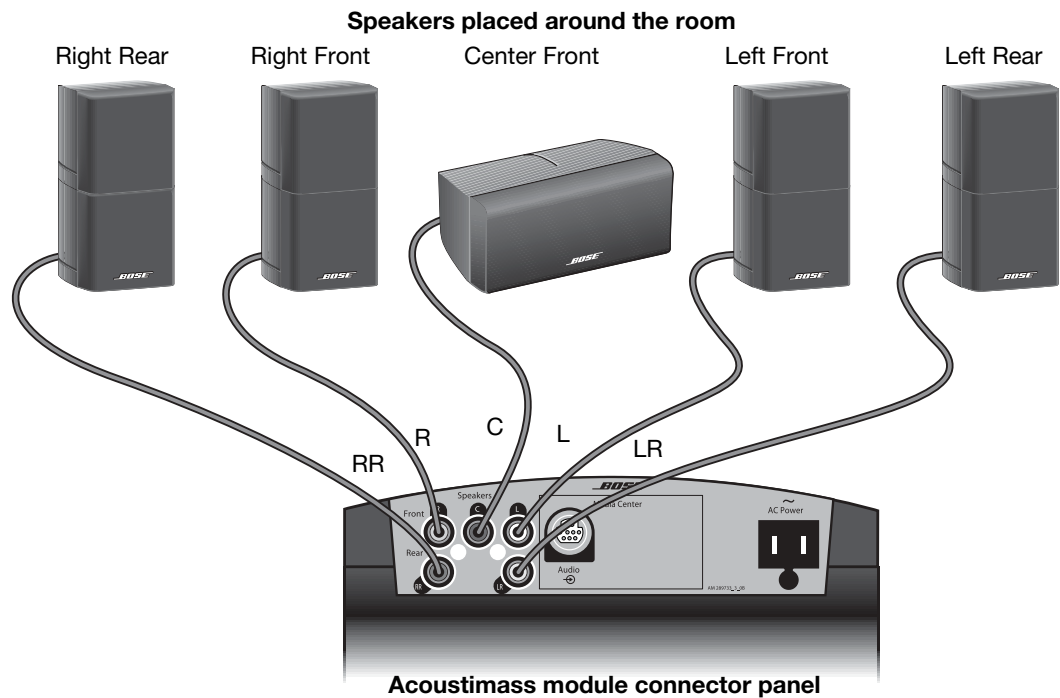

Connecting the module to the media center

Use the audio input cable, which has a multi-pin connector at each end, to connect the Acoustimass® module to the media center (Figure 11).

Figure 11

Audio input cable with a flat-sided multi-pin connector at each end

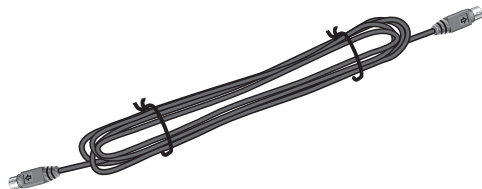

Note: Before you make this connection, you can plug the power adapter into the media center first, while there are no other cables in the way. However, **DO NOT** plug the adapter into the AC (mains) power outlet before all other connections are completed.

1. With the flat side of the multi-pin connector facing down, insert one connector end into the Audio jack labeled on the back of the Acoustimass module (Figure 12).

Be sure the connector is inserted flat side down.

2. Use the other end of the cable flat side up. Insert it into the Speakers jack labeled Main on the media center.

Make sure that each connector is fully inserted into the jack.

Figure 12

Acoustimass connection to the media center

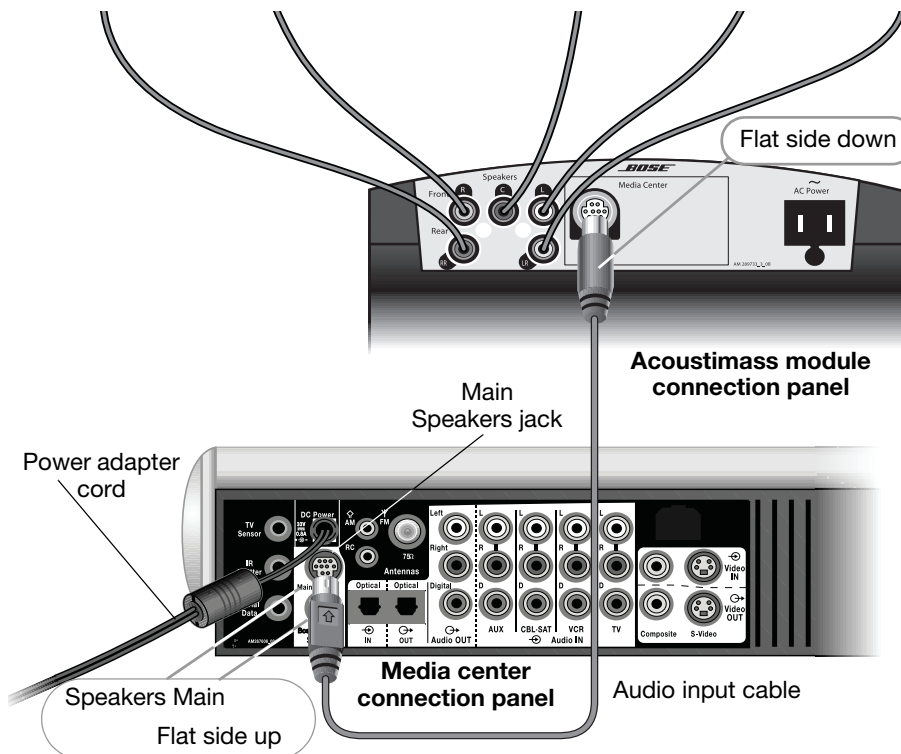

CAUTION: Do not put strain on the audio input cable where it connects to the module and media center. Excessive strain, caused by pulling directly on the cable or by compressing it, can cause damage.

Adding antennas for radio reception

The supplied AM and FM antennas also connect to the rear panel of the media center (Figure 13).

Figure 13

Connections for the AM and FM antennas

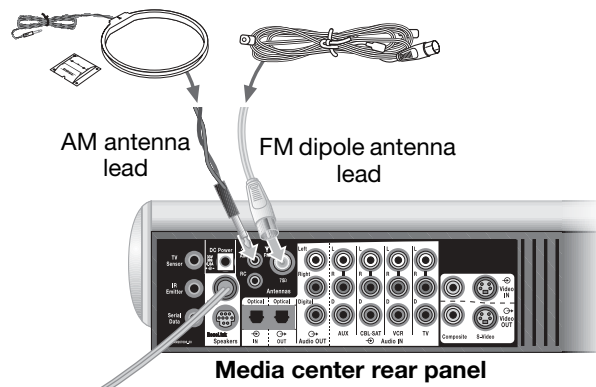

Note: The FM jack (75 ohm) may be used with an outdoor antenna. Before doing this, consult a qualified installer. Follow all safety instructions supplied with the antenna.

FM antenna

1. Plug the connector on the FM dipole antenna lead into the FM antenna jack.
2. Spread out the antenna arms and change their orientation as needed to get the best FM reception.
3. Place the antenna as far from the media center and other components as possible.

CAUTION: DO NOT connect your television antenna cable to the FM antenna jack.

AM antenna

1. Plug the connector on the AM antenna lead into the AM antenna jack.
2. Stand the loop antenna on the base or mount the antenna on a wall, following the instructions enclosed with the AM antenna.
3. Move the AM loop antenna as far as possible (at least 20 inches or 50 centimeters) from the media center, and at least 2 feet (60 centimeters) from the Acoustimass® module.

When all connections are completed and you can turn on your system, you may need to experiment with the orientation of the loop antenna for optimum AM reception.

Note: AM reception can be adversely affected by a nearby television, when it is on. Turn off the TV for best AM reception.

Cable radio

Some cable TV providers make FM radio signals available through the cable service to your home. This cable connects to the FM antenna jack on the back panel of the media center.

For instructions on how to make this connection, contact your cable TV provider.

Note: Make sure your cable radio installation includes a signal splitter to prevent the cable TV band from entering the media center. For details, contact a qualified installer.

Connecting your TV for viewing DVDs

Note: If you use a SCART connector (used in Europe), the information below does not apply. Refer, instead, to “Using a SCART adapter” on page 18.

On your media center, connect the Composite Video Out to the Video input jack on your TV (Figure 14).

1. Use the supplied video cable with a single yellow RCA connector on each end.
2. Notice which TV Video input you used, such as VIDEO 1 or VIDEO 3. You may want to write it down for future reference.

Figure 14

Composite video connection of a TV to the media center

Note: Your TV rear panel may look significantly different. It may have fewer jacks.

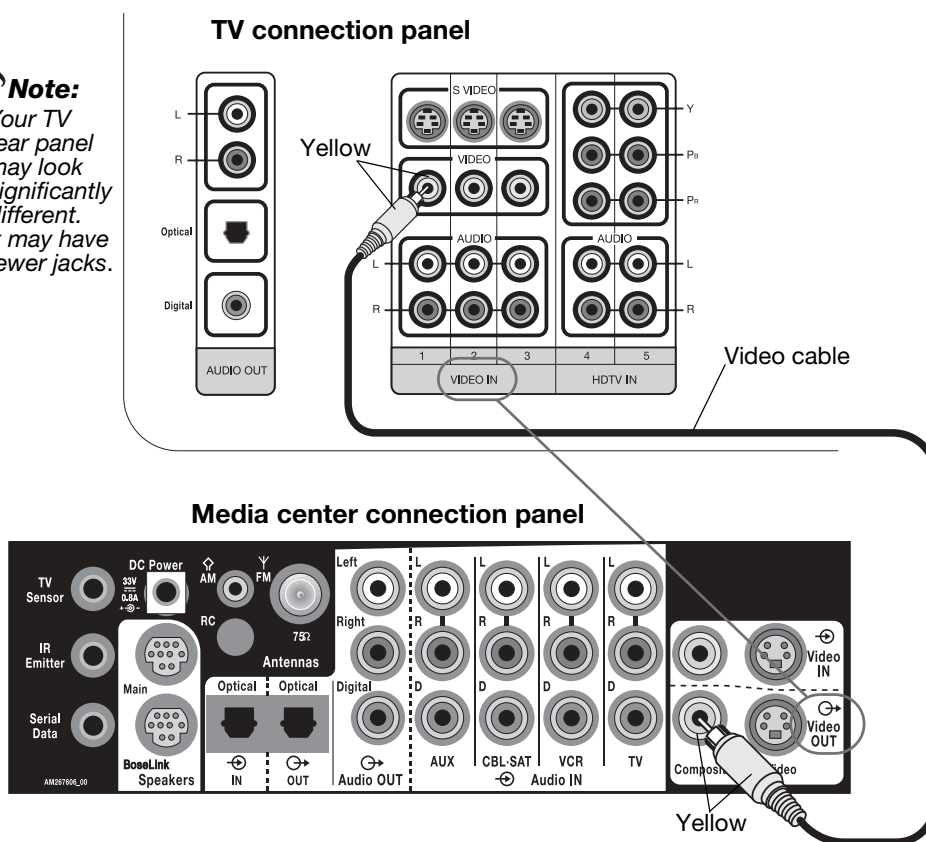

You may now:

- Proceed to “Completing the system power connections” on page 21.
- Read and consider “Connecting audio for your TV sound” on page 19.
- Refer to “Optional Connections and Additions” on page 26 for information on connecting other equipment to the system.

Note: For information on how to set the LIFESTYLE® remote to control the TV, refer to your Operating Guide.

Using a SCART adapter

The SCART adapter, for use with a SCART connector on a TV (of European manufacture), has five connectors that plug into media center (Figure 15).

Use the appropriate setting on the connector, according to the type of connection you make:

- The connector is currently set for a Composite connection (V-IN).
- Set it for S-Video (a higher quality image) if your TV accepts that type of video signal (S-IN).

♪ **Note:** If you see only black and white on your TV screen after setting the SCART connector for S-Video, set the connector back to Composite video (V-IN).

Figure 15

SCART connection with switch set for Composite video

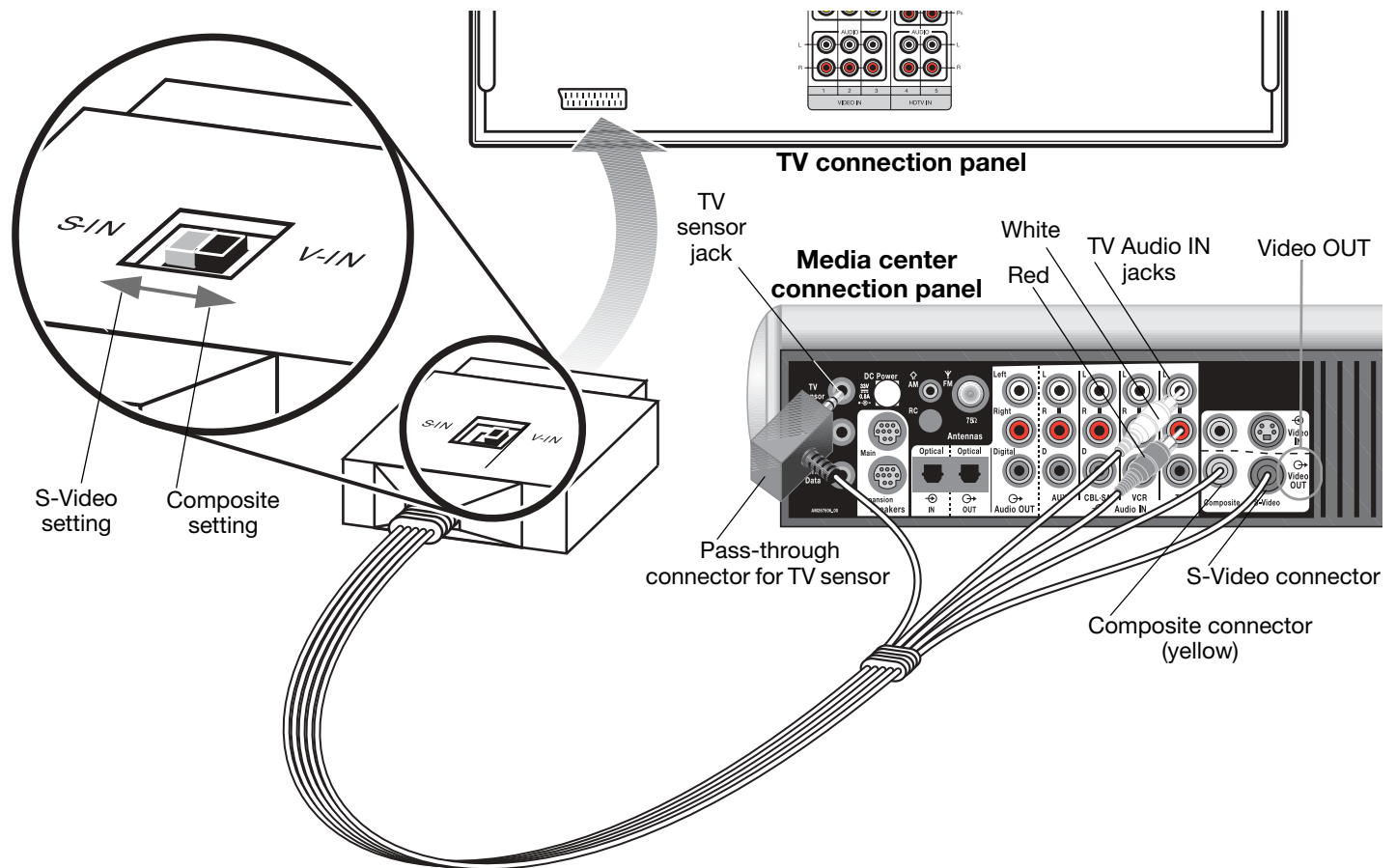

You may now:

- Read and consider “Connecting audio for your TV sound” on page 19.
- Proceed to “Completing the system power connections” on page 21.
- Refer to “Optional Connections and Additions” on page 26 for information on connecting other equipment to the system.

♪ **Note:** For information on how to set the LIFESTYLE® remote to control the TV, refer to your Operating Guide.

Connecting audio for your TV sound

You should make this connection if you:

- Change channels using your TV remote while viewing TV programs or cable that is connected directly to your TV (with no cable box).
- Connect the audio from other components, like a camcorder or game console, directly to your TV.

You do not need this connection if you:

- Use a set-top box (a cable box, for example) for TV viewing and changing channels, instead of your TV controls.
- Do not connect the audio from other components directly to your TV.
- Own a TV that does not have Audio Output jacks (as shown here).
If you need to connect another component (a game console, for example) directly to this TV, be sure to connect the audio from this component to the Audio In jacks on the media center. Then you can hear the sound from this component on your LIFESTYLE® system speakers.

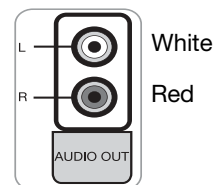

To skip the instructions below, move to “Completing the system power connections” on page 21.

To connect the TV audio

Use the supplied stereo audio cable that has two RCA connectors at each end. One is white and the other is red.

1. On the rear of your TV, insert the RCAs at one end of the cable into the left (L) and right (R) audio output jacks. Match white to L and red to R.
2. Match the colored RCAs at the other end of the cable to the TV Audio IN jacks on the media center: white in the L jack and red in the R (Figure 16).

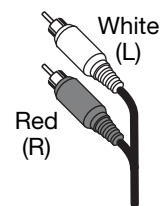
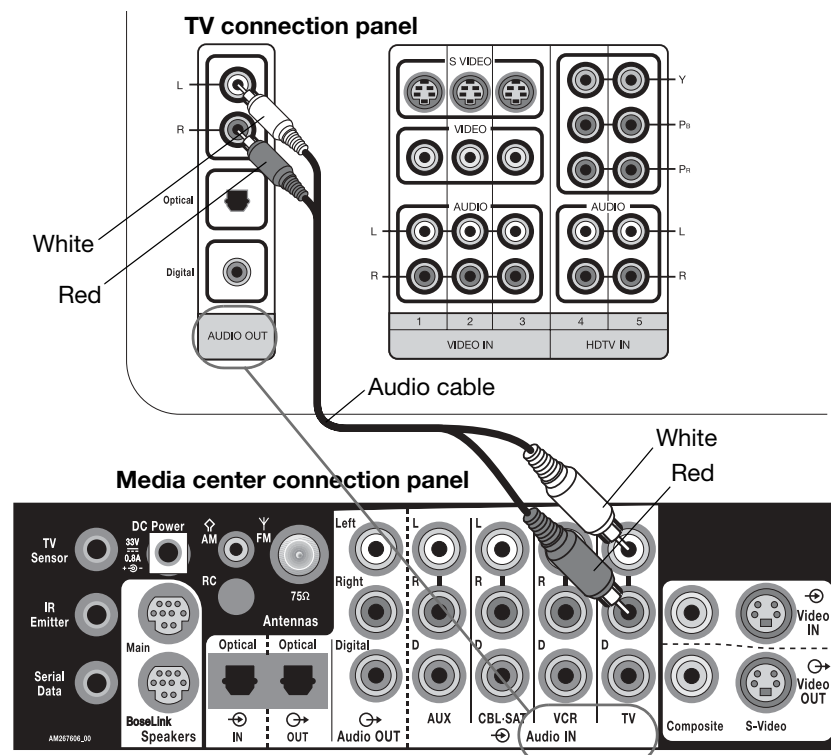

Figure 16

Audio connection between the media center and TV



BE SURE to read the next page: “Setting the TV properly is important”

Setting the TV properly is important

To hear your TV audio through your LIFESTYLE® system speakers, the internal speakers in your TV should be turned off.

The following describes the most common ways to make these changes to your TV. Be sure to refer to the owner's guide that came with your TV for instructions specific to your brand.

Choosing Speakers Off and Fixed Audio

Most TVs have a setup menu option for turning off speakers.

Using your TV setup menu:

1. Using your TV remote, display the audio menu on your TV screen.
In most cases, this can be done by pressing the Menu button and selecting Audio.
2. Locate the Speakers On/Off menu item and select Speakers Off.
3. Locate the Audio Output item and select Fixed.
4. Exit the audio menu on your TV screen.

🎵 Notes:

- *If your TV does not provide Fixed Audio as an option, but you were able to turn off the internal speakers, set your TV volume to about 80% of the maximum.*
- *If your TV provides both Fixed and Variable audio out jacks, be sure to use those marked FIX.*
- *If your TV does not have a menu setting, follow the instruction below to use the on/off switch, which is small and may be difficult to locate.*

Using your TV speaker on/off switch:

1. *Set the switch to the OFF position.*
2. *Adjust the TV volume to about 80% of the maximum.*

Refer to the owner's guide provided with your TV for further information on settings and switches.

Completing the system power connections

Note: Bose recommends using a high-quality surge suppressor on all electronics equipment. Voltage variations and spikes can damage electronic components in any system. A quality surge suppressor can eliminate the vast majority of failures attributed to surges and may be purchased at electronics stores.

Connect the two AC power (mains) cords in the following order:

1. On the connector panel of the Acoustimass® module, plug the appropriate end of the Acoustimass module power cord into the AC power jack (Figure 17).
2. Insert the other end of the power cord into the AC (mains) outlet.

Figure 17

Power connection for the Acoustimass module

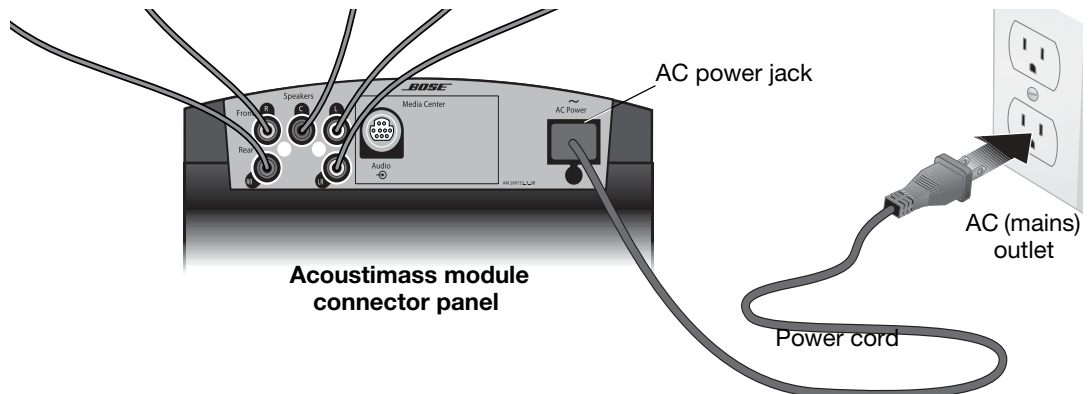

3. If you have not yet plugged the small round connector of the media center power supply cord into the DC POWER jack on the media center connection panel, do so now (Figure 18).

Figure 18

Power connection for the media center

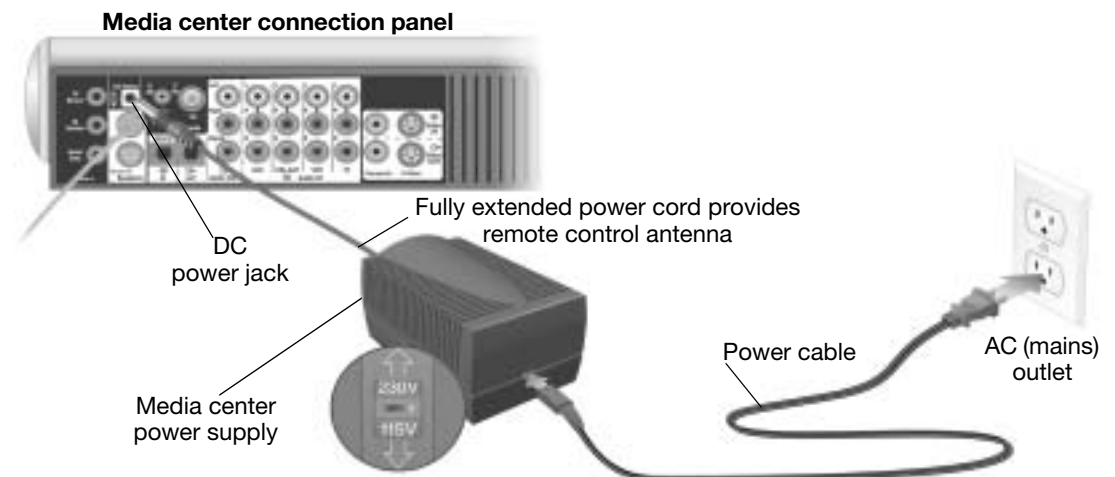

Note: For dual voltage units (sold in certain areas), MAKE SURE the voltage setting on the bottom of the media center power supply matches the local power rating (Figure 18). Check with local electrical authorities if you are not sure of the appropriate power rating.

4. On the media center power supply, insert the small end of the AC power cable into the power jack.
5. Plug the other end of the power cable into an AC (mains) outlet.

Installing the remote control batteries

On the rear of the remote:

1. Slide the battery compartment cover from the end.
2. Notice the polarity markings (+ and -) inside the compartment and match them with markings on each of the four batteries as you insert them into the compartment (Figure 19).
3. Slide the cover back on the remote until it snaps shut.

🎵 **Note:** Do not change the settings of the factory-preset miniature switches inside the battery compartment. They should be changed only as directed in the Reference section of the Operating Guide.

Figure 19

Remote control battery installation

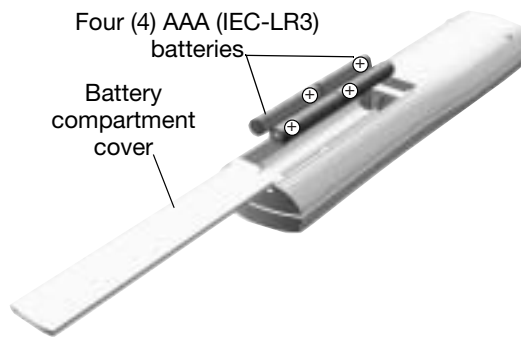

Replace all four batteries when the remote control stops operating or its range seems reduced. Alkaline batteries are recommended.

🎵 **Note:** For information on how to set the LIFESTYLE® remote to control the TV, refer to your Operating Guide.

Making sure the sound is as good as it gets

Your system comes with two compact discs (Figure 20). Using them is the final step to basic installation of your new LIFESTYLE® DVD home entertainment system.

- Use Setup Disc 1 to verify that your speakers are connected correctly and for other tips you may find useful.
- Use Setup Disc 2 to follow the ADAPTiQ® audio calibration process, which tailors the sound of your LIFESTYLE® system very specifically to the acoustics in your room.

The special headset, designed to be worn *above your ears*, takes acoustic measurements for you during the process. Put on the headset only when prompted by Disc 2.

Figure 20

Setup discs and ADAPTiQ audio calibration system

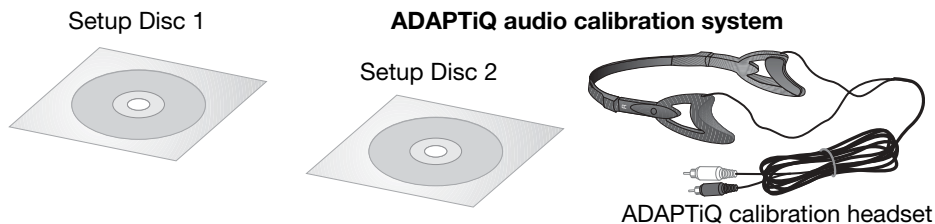

- Play both discs when all of the speakers are where you want them, your furnishings are arranged as intended, and all of the system connections are completed.
- Allow approximately 30 minutes to complete the process.
- Begin the process when you are unlikely to be disturbed and when the acoustic measurement tones (not loud, just weird) are unlikely to disturb anyone else.

Using System Setup Disc 1

1. Use the TV remote to turn on your television.
 2. Select the TV Video input used to connect to the media center.
- 🎵 **Note:** *If you wrote down which input you used, you may want to refer to that.*
3. Lift up the media center front cover and press **Open/Close** on the control panel.
 4. Insert Setup Disc 1 into the tray (label side up) and press **Open/Close** again.
 5. Using the remote control, press the **CD/DVD** button.
 6. Listen carefully as the disc begins to play and follow the simple instructions until Disc 1 tells you it is time to play Disc 2.

Using Disc 2 for ADAPTiQ® audio calibration

Replace Disc 1 with Disc 2 in the disc tray and continue with the steps that follow:

1. Connect the ADAPTiQ calibration headset to the AUX jacks on the connection panel of the media center as shown in Figure 21 on page 24.

BASIC SYSTEM CONNECTIONS

Figure 21

Using the ADAPTIQ® calibration headset

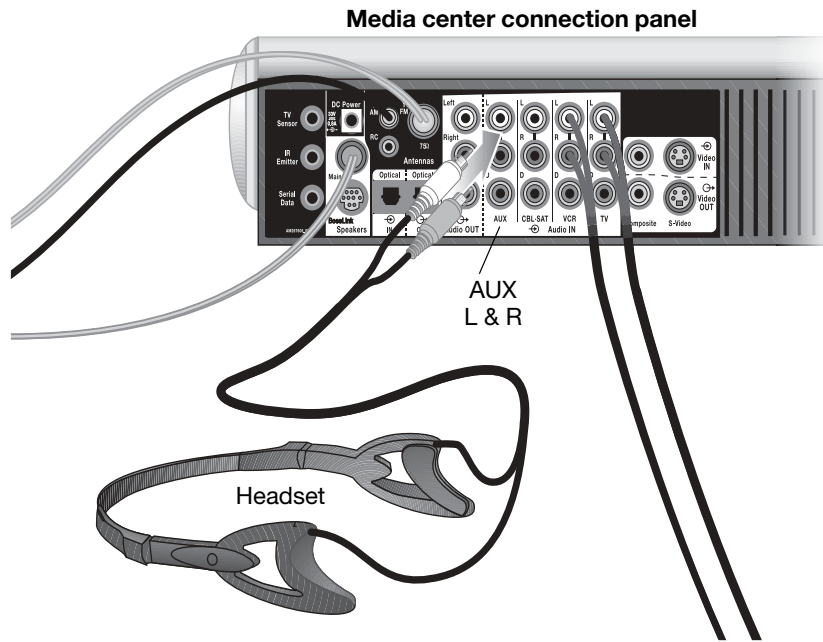

2. Put on the headset so it rests *above your ears*. In this position, it can listen (as you would) and take sampling measurements in your room during the ADAPTIQ audio calibration process.
3. Follow the calibration process as directed on the TV screen.

Save the headset for possible future use

Keep the headset and discs together in their original carton and store them in a safe location.

You may want to customize your system again if you move it to another room or significantly change the arrangement of the room by relocating furniture, the speakers, or the Acoustimass® module. You can reuse the ADAPTIQ system at any time.

Taking the next steps

This completes the basic connection of your system and TV.

Now you can:

- Install the TV on/off sensor, following instructions in the next section of this guide.
- Connect other components to the system, as instructed in “Optional Connections and Additions” on page 26 of this guide.
- Use the system as it is now set up. Refer to your *Operating Guide* for details.

Installing the TV on/off sensor

The TV on/off sensor works with the system to automatically turn on the TV, as needed, when another video source (DVD, cable/satellite box, etc.) is selected. If you choose not to use the sensor, you need to turn on your TV separately.

🎵 **Note:** For information on how to set the LIFESTYLE® remote to control your TV and work with the sensor, refer to your Operating Guide.

For a larger TV, you may want a second person to help as you follow the steps below:

1. Plug the sensor cord connector into the TV SENSOR jack on the media center. If you are using a SCART adapter, plug the sensor directly into the pass-through jack provided on the adapter (Figure 15 on page 18).
2. Temporarily position the TV on/off sensor on the back of your TV.

🎵 **Note:** DO NOT attach the supplied mounting strip until you have tested and activated the automatic feature as explained below.

Figure 22

TV on/off sensor installed on your TV

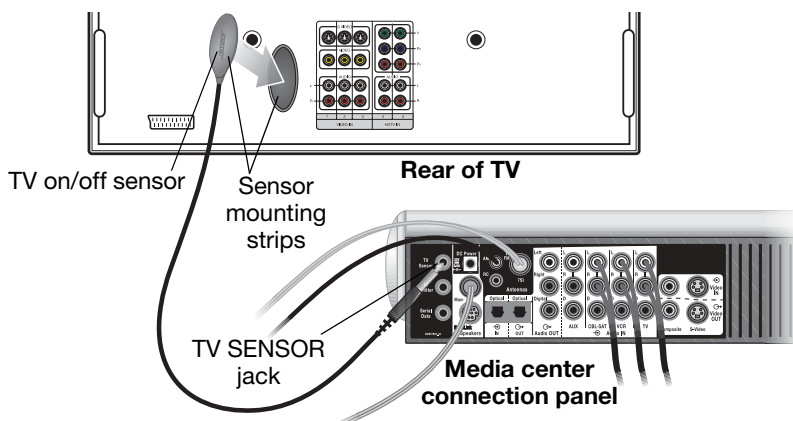

🎵 **Note:** Mount the sensor on the bottom rear of a projection TV chassis. Front projectors with a separate screen may not work with the sensor.

3. Turn on your TV to test the sensor and activate the feature.
 - A. On the LIFESTYLE® system remote control, press **System**. Use the arrows to move around the on-screen menu and press **Enter** to make selections:
 - B. On the TV screen, move right to **Video** and press **Enter**.
 - C. On the rear of the TV, move the sensor as needed, and notice when the on-screen **TV Power Status** changes from **TV not detected** to **TV ON**.
 - D. Attach the included mounting strips, one to the sensor and one to the TV, and press them together to hold the sensor in this effective position.
 - E. On the TV screen, move down to **TV Power**, and select:
 - **Automatic** (for TV models that do not use a European-style SCART connector).
 - **Euro Connector** (for TV models that use a SCART connector).
 - F. Press **Enter** to confirm this setting.
 - G. Press **Exit** to leave the System menu. This completes activation.



OPTIONAL CONNECTIONS AND ADDITIONS

Considering higher-quality connections

For online assistance in making additional connections, or choosing the most appropriate means to connect your specific TV, please visit our website: owners.bose.com.

Note: At this time, the website mentioned above is provided in English only.

Determining the options for your setup

Besides the analog audio and composite video connections from the TV to the media center (shown earlier in this guide), there are other options that can provide better performance.

However, your choices depend on:

- the type of TV you own
- any other audio and video components you want in your home theater system setup
- the cables you have on hand or are willing to buy to connect the following:
 - PVR or DVR (a personal or digital video recorder)
 - VCR (a video cassette recorder)
 - Cable or satellite box
 - Game console
 - DVD changer
 - Recording equipment

To determine how you will connect and use added components, read the sections that follow.

Making other audio connections

There are two types of audio connections you can make for adding components:

- Analog connections, the most commonly used, require an analog cable with white and red connectors at each end. One such cable (shown on the right) is provided with the system.
- Digital connections require either coaxial digital cable (with a single RCA connector at each end) or optical cable (with a special square connector at each end). If your digital components do not include cables, you can find these cables in consumer electronics retail stores.

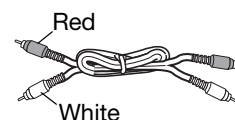

Coaxial digital cable



Optical digital cable



Note: When using a digital audio connection, be sure to maintain your analog connection, too. In this way, you ensure continuous sound when a digital signal is absent or interrupted. It also supports the use of a Bose® link connection for expansion into other rooms.

Choosing digital audio

If your TV, VCR, tape deck, or AUX component has the proper output jacks, you can make a digital audio connection to the media center (Figure 23).

Figure 23

Digital audio and other media center panel connections

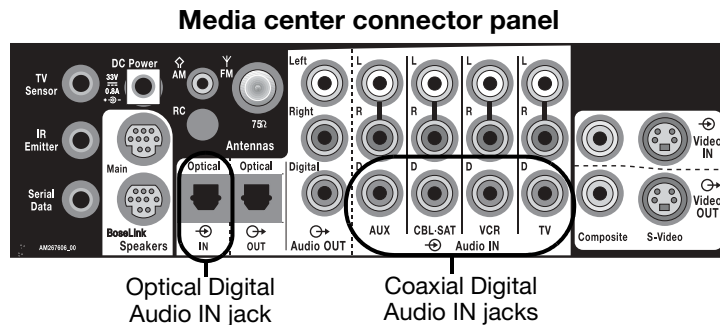

- For a coaxial connection, use a 75-ohm cable with RCA connectors. Connect it to the Digital jack for that component: TV, CBL/SAT, VCR, or AUX.
- For an optical connection, insert an optical digital cable (with a square connector) into the Optical IN on the media center rear panel.

Note: To make digital recordings from a connected optical component, connect another optical cable to the Optical OUT jacks on the media center rear panel.

Activating an optical connection

Before you can listen to a source connected to the Optical IN jack on the media center, you **MUST** activate that connection:

1. Turn on your TV.
2. On the LIFESTYLE® system remote control, press **System**. Use the arrows to move around the on-screen menu and press **Enter** to make selections:
 - A. On the TV screen, move right to **Media Center** and press **Enter**.
 - B. Move down the menu to **Optical Source** and press **Enter**.
 - C. Select the component that is connected to the media center using optical cable.
 - D. Press **Enter** to confirm this setting.
 - E. Press **Exit** to leave the System menu. This completes activation of your optical connection.



Using advanced video connections

The video cable supplied with your LIFESTYLE® system affords the most basic composite connection.

In earlier instructions, composite cable is used to connect the Video OUT on the media center to the TV Video IN. This connection serves to carry the DVD image to the TV screen.

Using a composite connection has its drawbacks:

- It restricts use of the Video IN jack on the media center to a composite connection only. The media center passes only like signals through to the TV.
- Connecting another component to the Video IN jack requires an additional composite cable, which is not supplied with the system.

♪ **Note:** To see this type of Video IN connection, refer to “VCR connections” on page 30.

- You do not get the best video image possible from DVDs or a second video source.

If your TV supports a higher-quality Video input connection, we suggest using that instead. Refer to “Moving beyond composite to S-Video”(below) and “Connecting for progressive scan or HDTV” on page 29.

Moving beyond composite to S-Video

An S-Video input jack, provided on many TVs, delivers higher picture quality than composite video output.

For this type of connection to the TV, use the supplied S-Video cable. Insert one end into the S-Video OUT jack on the media center and the other end into the S-Video input on your TV.



♪ **Note:** To see this type of connection, refer to the diagram and instructions on using “Cable or satellite box options” on page 31.

Using an S-Video connection means:

- It restricts use of the Video IN jack on the media center to an S-Video connection only. The media center passes only like signals through to the TV.
- Connecting another component to the Video IN jack requires an additional S-Video cable, which is not supplied with the system.
- A second component can be added by using a composite connection to Video IN on the media center and a composite connection from the Video OUT to your TV.

♪ **Note:** For details on connecting two components, refer to the diagram and instructions on “Connecting a VCR in addition to cable/satellite” on page 32 or “Connecting a DVR in addition to cable/satellite” on page 33.

Connecting for progressive scan or HDTV

Your TV may provide Component Video In jacks (right) and offer progressive scan or HDTV capability. In this case, a component connection is the proper choice. It provides both higher image definition and more brilliant color.

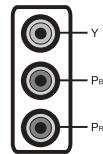

- 🎵 **Note:** Use of this component video adapter is not an option for TVs with a SCART adapter connection to the media center.

Using a Component connection means:

- It restricts use of the Video IN jack on the media center to a Component connection only. The media center passes only like signals through to the TV.
- It requires use of a component cable, which is not supplied with the system. Component cables, which have three colored RCA connectors at each end, are available from consumer electronics retail stores.
- Your component cable connects to the media center using a supplied Component video adapter (Figure 24).
- There are two adapters provided with your LIFESTYLE® system. One is to connect your TV to the Component Video OUT jack. The other is to connect another component to the Component Video IN jack on the media center.

Figure 24

Component video jacks on a TV and the provided Component video adapters

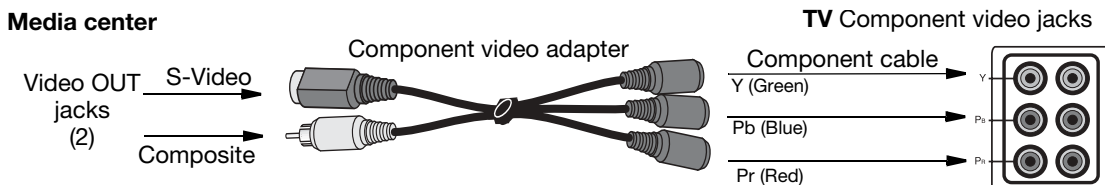

- 🎵 **Note:** This type of connection requires a setting change in the LIFESTYLE® system menu. For details, refer to the diagram and instructions on using "Component video connections as another option" on page 34.

Making these additional video connections

- ⚠️ **CAUTION:** Before connecting additional equipment to your system, be sure to turn off and unplug both the LIFESTYLE® media center and the Acoustimass® module.

The LIFESTYLE® media center offers:

- Audio IN jacks labeled AUX, CBL-SAT, VCR, and TV.
- Two Video IN jacks, one labeled Composite and the other S-Video, for adding one or two compatible video devices.
- The coupling of Composite and S-Video jacks on the media center for use with the Component Adapter to provide component video.

- 🎵 **Note:** If you use a Component video connection between the media center and the TV, you **MUST** make any other video connection to the media center using a component cable and adapter. Neither S-Video nor Composite video signals can pass through the media center to the TV.

VCR connections

Most VCRs feature only Composite video output jacks.

- If you are connecting a VCR only, follow Steps 1 and 2 below.
- If you are connecting both a VCR *and* cable or satellite box, skip to “Cable or satellite box options” on page 31.

To connect your VCR directly to the media center

1. Using audio cables (with dual RCA connectors at each end), connect the left (L) and right (R) audio outputs on your VCR to the L and R Audio IN jacks for VCR on the media center rear panel (Figure 25).
2. Using a video cable (with one yellow RCA connector at each end), connect Video OUT on the VCR to Composite Video IN on the media center.

Figure 25

VCR connection only

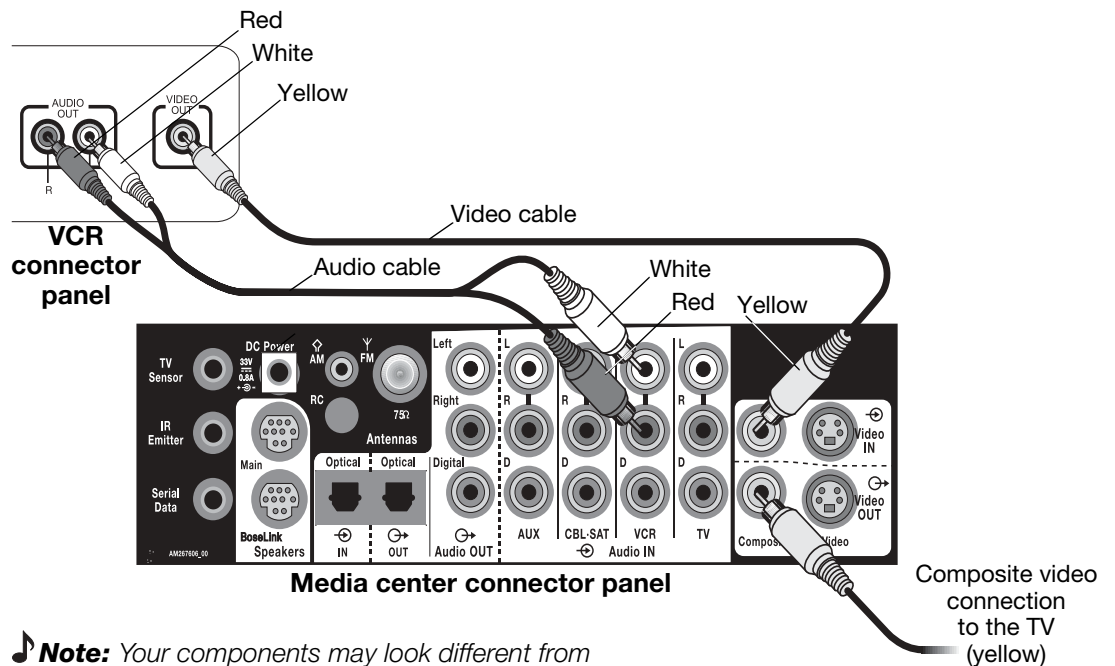

Note: Your components may look different from those shown above. The connection jacks and labels also may differ.

Cable or satellite box options

There are several ways to make the cable/satellite connections. Read these instructions to see how they will work with the components you own. If you have component jacks (three colored jacks) on your cable or satellite box *and* on your TV, you may prefer using another type of connection (refer to “Connecting a DVR in addition to cable/satellite” on page 33).

To connect the cable or satellite box

Connect cable/satellite L & R Audio OUT to the L & R Audio IN jacks for CBL/SAT on the media center (Figure 26).

1. Make the audio connection:
 - Connect the L and R Audio output jacks from the cable/satellite box to the L and R Audio IN for CBL/SAT on the media center.
2. Make the video connection:
 - Make EITHER a composite (A) OR an S-Video (B) connection from the cable or satellite box to the media center and use the SAME type of connection from the media center to a TV Video input (Figure 26).
 - A. If the cable/satellite box has only a Composite video output jack, connect that to the Composite Video IN jack on the media center.
 - B. If the cable/satellite box has an S-Video output jack, connect it to the S-Video IN jack on the media center. Then use another S-Video cable to connect the S-Video OUT jack on the media center to a Video input jack on the TV.

Figure 26

TV and media center connections for a cable or satellite box

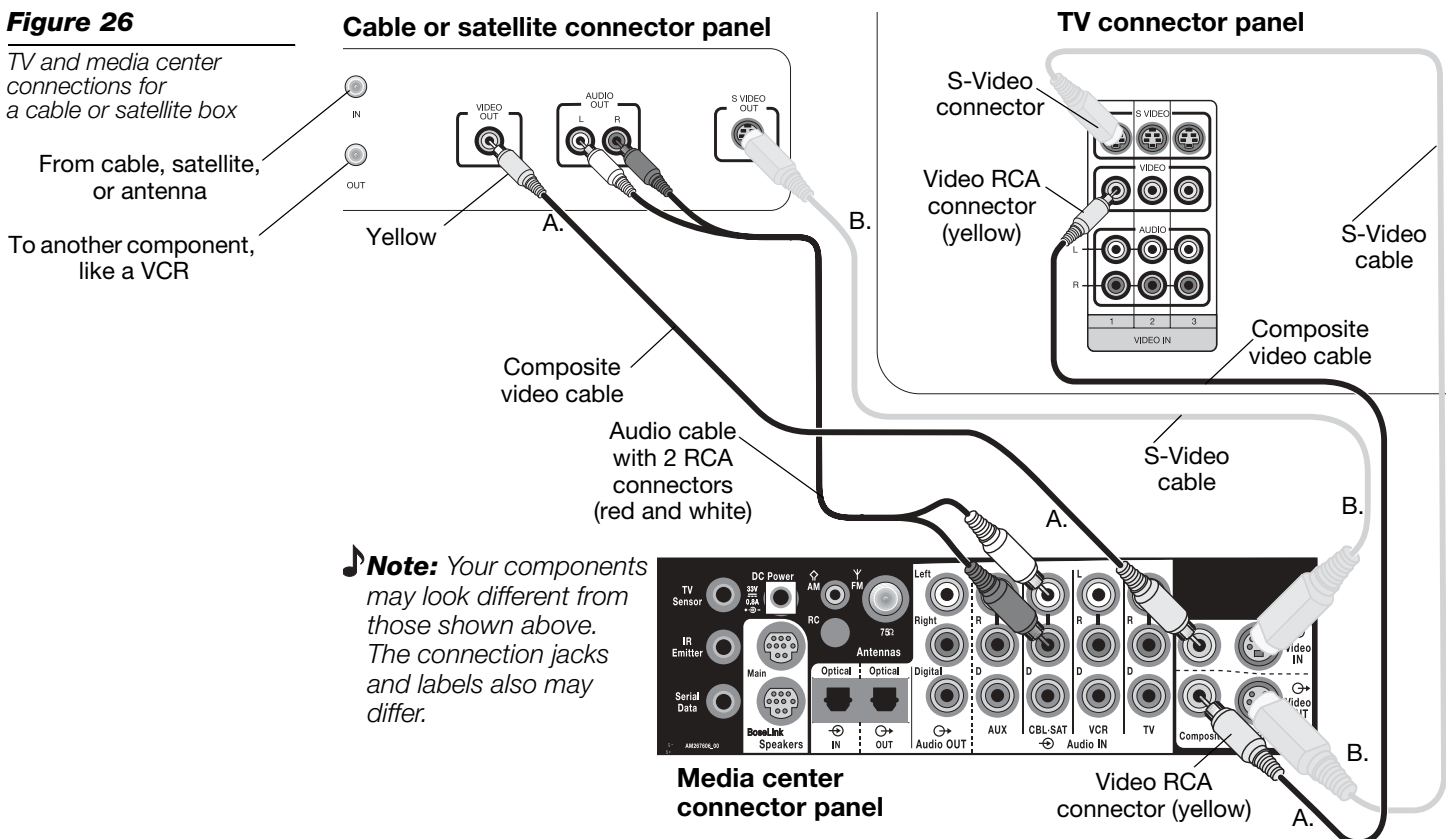

Connecting a VCR in addition to cable/satellite

If you are connecting more than one additional component to the media center, you may want to use an optional VS-1 accessory, offered by Bose to simplify these connections.

Note: For information about the optional Bose® VS-1 video expander, refer to “Accessories” on page 40.

Making these connections requires use of coaxial, S-Video, and composite cables.

1. Use coaxial cable to connect the cable or satellite box to the VCR (Figure 27).
2. Use the S-Video cable to connect the Video Out from your cable or satellite box to the one S-Video jack for Video IN on the media center.
3. Use a composite video cable (with a yellow RCA connector at each end) to connect the VCR Video Out to the media center composite (yellow) Video IN.
4. Connect the S-Video and Composite Video OUT jacks from the media center to Video In jacks on the TV. Connect them to different inputs.
5. When your LIFESTYLE® remote is set to control the TV, use the TV Input button to select the proper TV Video input for the VCR or cable/satellite picture.

If you must connect both S-Video and composite cables to the same set of Video input jacks on the TV, you also must turn off one of the two connected components to watch the other.

Figure 27

VCR and cable or satellite box connections to the media center and TV

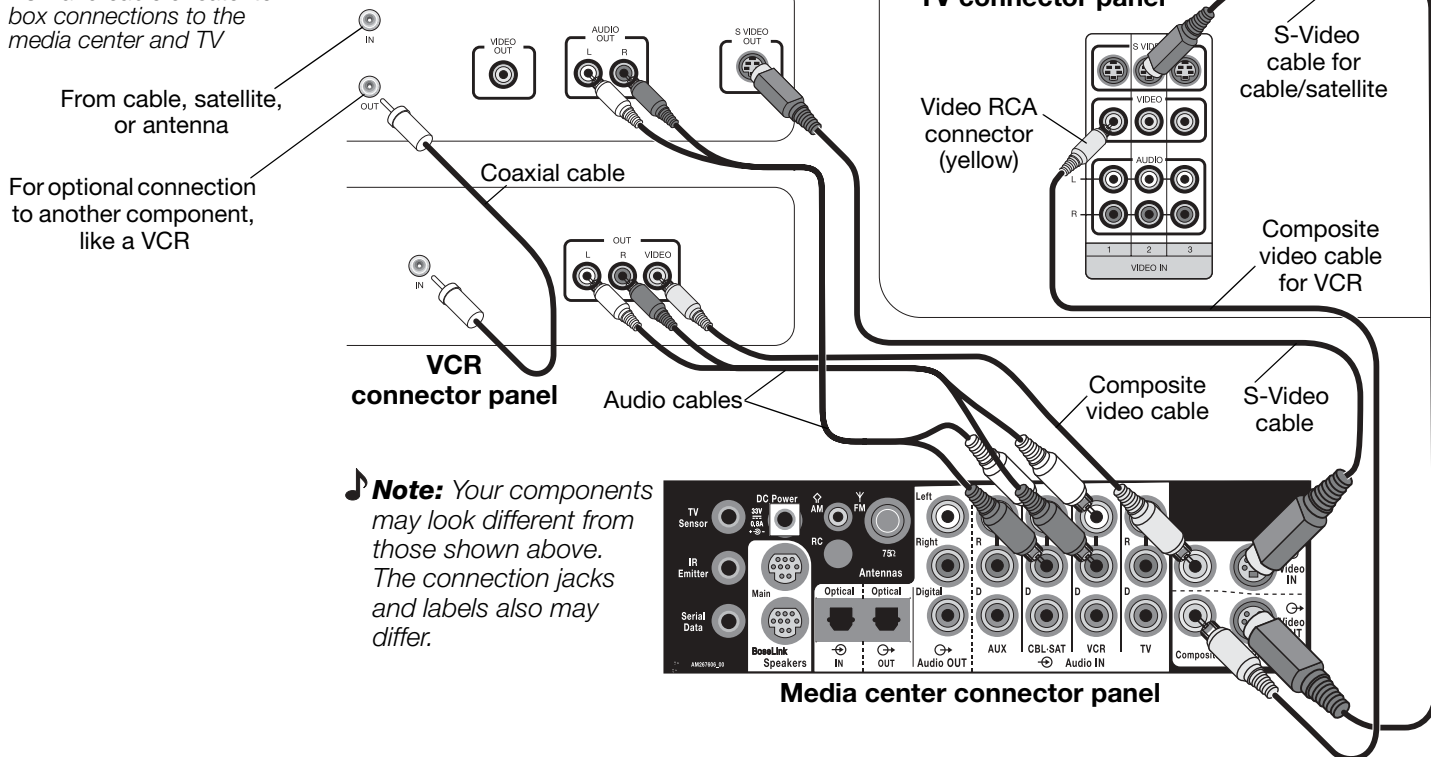

Note: Your components may look different from those shown above. The connection jacks and labels also may differ.

Connecting a DVR in addition to cable/satellite

This requires making both S-Video and composite connections (Figure 27).

- Use the coaxial cable to connect the cable or satellite box to the DVR.
- Make the DVR audio connection:
 - Connect the L and R Audio output jacks from the DVR to the L and R Audio IN for VCR on the media center.
 - To use the DVR features, be sure to select the VCR source using your LIFESTYLE® remote control.
- Make the video connection:
 - Make EITHER a composite (A) or an S-Video (B) connection from the DVR to the media center and use this SAME type of connection from the media center to a TV Video input (Figure 28).
 - A. If the DVR has only a Composite video output jack, connect that to the Composite Video IN jack on the media center.
 - B. If the DVR has an S-Video output jack, connect it to the S-Video IN jack on the media center. Then use another S-Video cable to connect the S-Video OUT jack on the media center to a Video input jack on the TV.
- Make an optional audio connection from the cable or satellite box:
 - Connect the L and R Audio output jacks from the cable or satellite box to the L and R Audio IN for CBL-SAT on the media center.
 - To use cable or satellite box menus (for Pay Per View or Video on Demand), be sure to select the SAT source using your LIFESTYLE® remote control.

Figure 28

DVR and cable or satellite box connections to the media center and TV

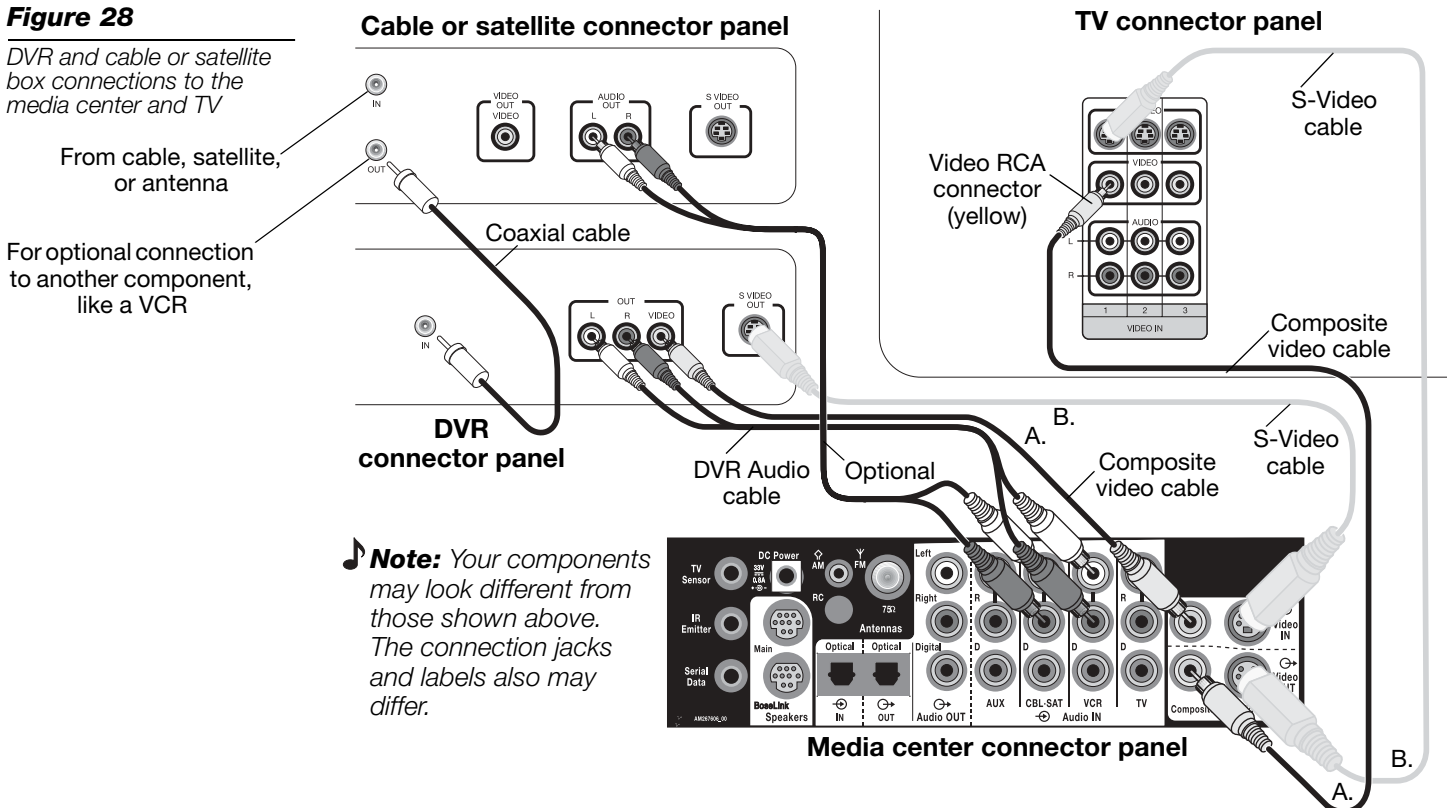

Note: Your components may look different from those shown above. The connection jacks and labels also may differ.

Component video connections as another option

Using a component connection to your TV provides the highest-quality video reproduction of DVDs.

This requires using two component cables (not supplied) and both of the supplied component video adapters.

1. Use one cable and an adapter to connect an audio/video device (cable or satellite box) to the media center (Figure 29).
2. Use the second cable and an adapter to connect the media center to the TV.
3. Be sure to activate the component video feature of your system when these connections are completed. Follow the instructions on page 35.

Note: For more details on component connections, refer to "Connecting for progressive scan or HDTV" on page 29.

Figure 29

Component video connections

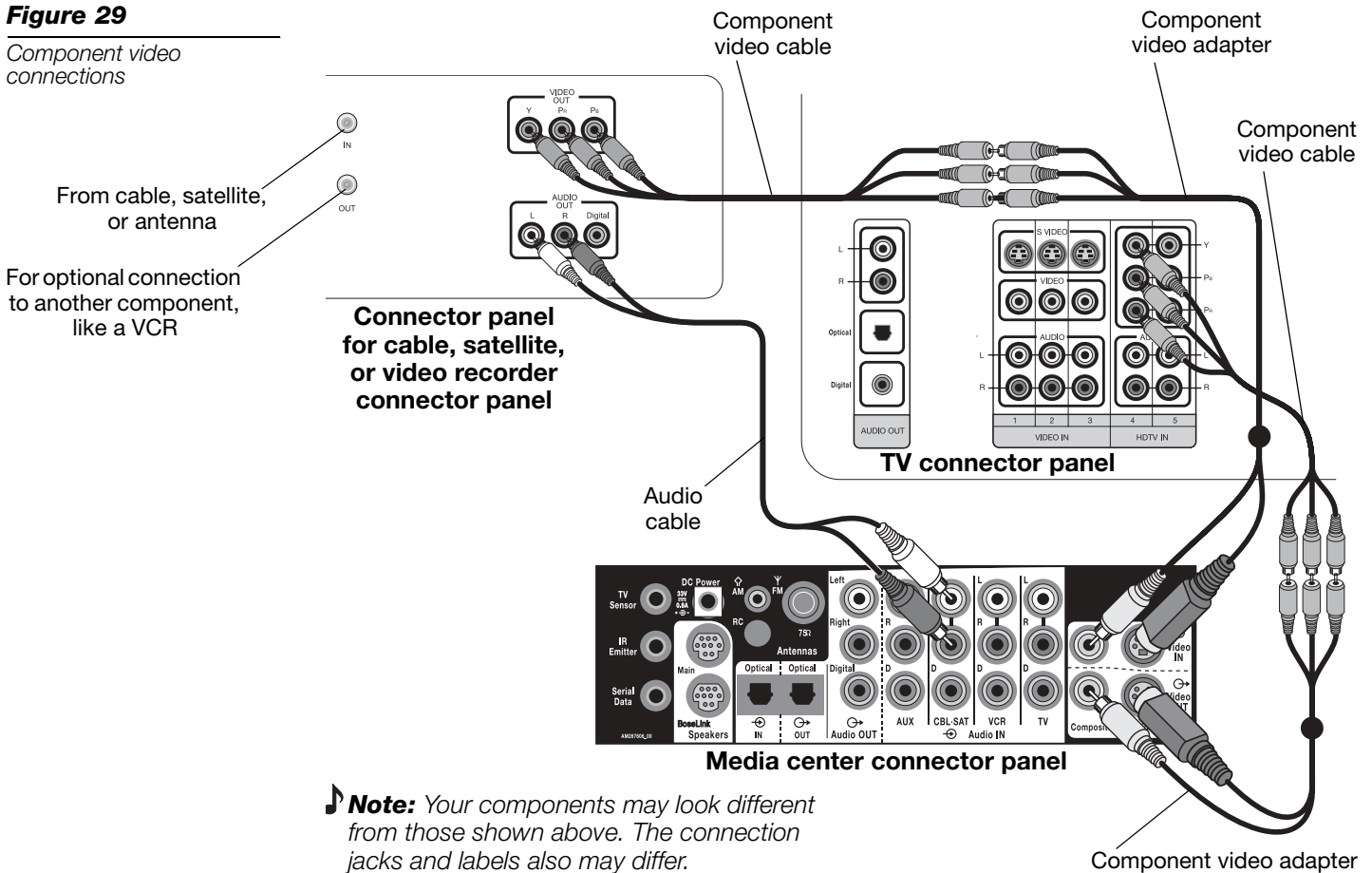

Note: Your components may look different from those shown above. The connection jacks and labels also may differ.

To add a VCR to the above setup, we recommend using an optional VS-1 video expander. Using it you can make a composite connection for your VCR, an S-Video connection for your cable, and a component connection to your TV.

Note: For information about the optional Bose® VS-1 video expander, which can simplify your connection decisions, refer to "Accessories" on page 40.

Activating component or progressive scan connections

With the LIFESTYLE® media center turned off, use the front panel controls and follow these steps:

1. Press and hold the Enter button on the media center.
2. While holding down the Enter button, press the Store button.
 - Selections will appear on the media center display each time you press Store.
 - Move down using the Volume down button on the media center console.
3. When **Video** appears as the selection on the display, release the Store and Enter buttons.
4. Use the Volume up and down buttons to scroll to the appropriate **Video** option.
 - For a component connection only, select:
 - **NTSC COMPONENT** (North American standard)
 - **PAL COMPONENT** (European standard)
 - **MULTI COMPONENT** (for TVs compatible with both NTSC and PAL formats)
 - For a component connection *and* progressive scan, select:
 - **NTSC PROGRESSIVE** (North American standard)
 - **PAL PROGRESSIVE** (European standard)
 - **MULTI PROGRESSIVE** (for TVs compatible with both NTSC and PAL formats)
5. With the proper selection made, press Enter to confirm the selection and leave the **Video** options display.

The system is now ready to deliver the DVD video signal you prefer.

Cables and considerations for further additions

Use standard RCA audio cables, inserting the white connector into the L (left) jack Audio IN jack and the red connector into the R (right) jack (Figure 30).

- If the component does not have right and left output jacks, use a Y adapter to connect it to the media center. Appropriate cables and adapters are available at most electronics stores.
- If the component has a digital output, use the corresponding digital input beneath the set of analog (L and R) inputs. Or, if the component has an optical output, you can use the optical input on the media center. With either type of digital connection, be sure to use an analog connection as well.

Note: If you make an optical connection, be sure to activate it following the instructions in “Activating an optical connection” on page 27.

Connecting external playback equipment

Other playback components, like an audio CD changer, can be connected to the AUX or other unused inputs on the rear panel of the media center (Figure 30).

Figure 30

AUX input connections

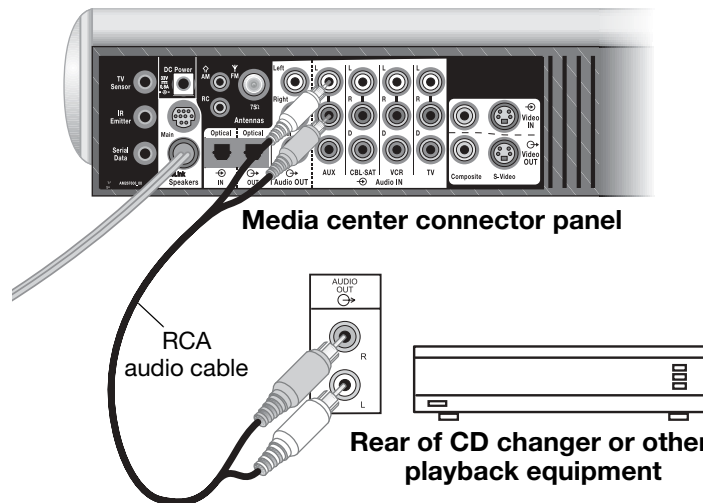

Connecting record/playback equipment

The rear panel of the media center provides input (AUX) jacks for listening to and output (Audio OUT) jacks for recording to a cassette tape deck (Figure 31).

Figure 31

Record/playback connections

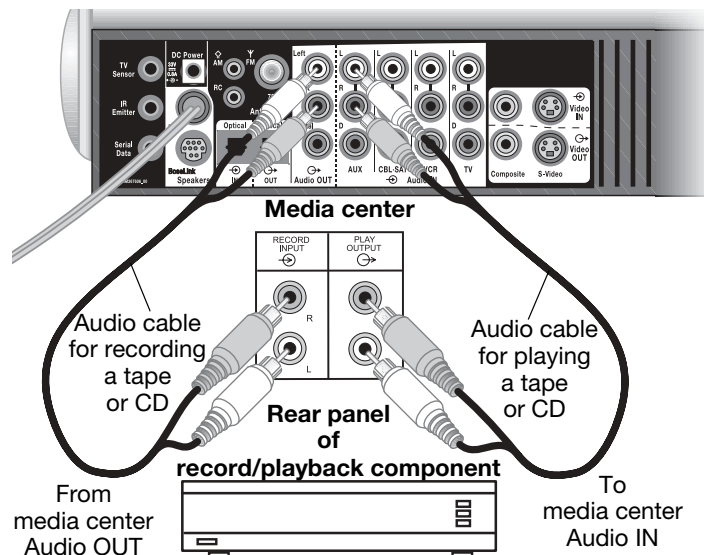

Connections for other needs

There are other, optional connections you can make as needed (Figure 32).

Figure 32

Additional jacks on the media center rear panel

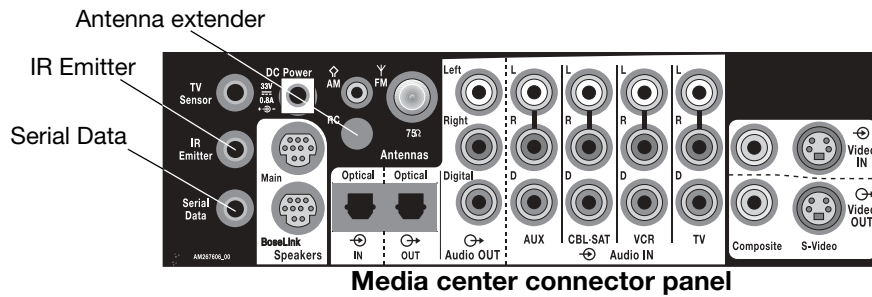

Antenna extender

If your remote control does not communicate with the media center, but the batteries are still good, you may need an antenna extender to increase transmission range. To contact Bose to purchase an extender, refer to the address list included in the carton.

IR emitter cable (supplied)

If a component does not respond to the LIFESTYLE® system remote control commands, the IR (infrared) signals may not be reaching it. Try moving the component or media center slightly to see if that improves the response.

If there is still a problem, connect the supplied IR emitter to establish a solid response while setting your LIFESTYLE® remote to control this component. You may not need to use the emitter after that. Or keep it connected, as needed, for use with one component.

Note: For information on how to set the LIFESTYLE® remote to control the TV, refer to your Operating Guide.

To connect the emitter:

1. Insert the 3.5 mm plug at one end of the cable into the IR Emitter jack on the media center panel.
2. At the other end of the cable, place the rounded surface near the component.
3. Move the emitter around, as necessary, to find the best position.
4. Use the double-sided tape enclosed with the emitter to affix it in position near the component.

Note: To purchase an add-on IR emitter for use with up to three components, or for replacement of the supplied emitter, contact Bose Customer Service. Refer to the address list included in the carton.

Serial data jack

This jack is for use with the Bose® VS-1 video expander, which simplifies connection of multiple audio video components, as described in “Accessories” on page 40.

Getting further advice for your components

If you have not found the information needed to make the connections for your particular equipment, Bose offers other means of help.

We offer online assistance that provides an interactive guide and illustrations geared to specific setups. Please visit our website at: owners.bose.com.

 **Note:** *At this time, the website mentioned above is provided in English only.*

Or, if you have specific questions or need help in assessing a problem, be sure to contact Bose directly. Refer to the address list provided in the carton.

Enjoying your system in other rooms

Your media center connection panel provides two audio output jacks identified by the label “Speakers.”

- Main, the top one, sends audio to the speakers connected to the media center in the main room.
- Bose® link, located just below Main, connects a cable that carries the sound to other speakers in other rooms.

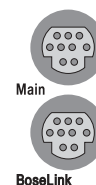

By using the Bose link option, you can add a variety of other Bose systems, speakers, and amplifiers (some designed specifically for this use) in up to 15 rooms total. Much more than simply extending the reach of your system, however, it adds another level of choice. From this one system, you can play two different sources in different areas of your house at the same time, indoors and out.

For this purpose, Bose offers you the AL8 homewide wireless audio link or two types of cables that connect to the Bose link jack:

- Bose link A cable, which is designed for use with a LIFESTYLE® SA-2 or SA-3 amplifier for passive Bose speakers (and included in the carton with either amplifier).
- Bose link B cable, designed for adding other Bose link-compatible systems and to be purchased at the same time. Your choice of systems includes:
 - Wave® music system
 - 3•2•1™ Series II, 3•2•1 GS Series II, or 3•2•1 GSX system
 - LIFESTYLE® RoomMate® speakers

In addition to the above specialized cables, our Bose link-compatible product line includes:

- Remote controls for use outside the main room where your LIFESTYLE® system is installed
- Expansion/extension cables for long runs into other rooms or adding multiple other rooms
- Cable adapters that may be required by your particular product for this purpose

Adding other products

Besides having the Bose link-compatible product line to choose from, you may prefer to use a Bose product you already own with your LIFESTYLE® system. Products that pre-date Bose link product engineering are referred to as legacy products and require special consideration when added to the product mix.

To adapt a legacy product:

The tips below apply to products that pre-date Bose link-compatible products:

- Powered Acoustimass® 5 or Acoustimass 20 speakers require a variable DIN adapter (Bose PN278894-103)
- Model SA-1 LIFESTYLE® stereo amplifier, for use with passive Bose speakers, restricts to one pair the number of speakers you can add
- Any Wave® radio or other legacy Bose system (a 3•2•1 Series I system, for example) requires use of a variable DIN adapter (Bose PN278894-103)

For a Bose remote control to work with the above products, you must set its Room Code to 0.

🎵 **Note:** For information on setting a Room Code for the RC18S remote control or the PERSONAL® music center II, refer to the owner's guide for the accessory.

To properly connect and control additional speakers, you need:

- Another LIFESTYLE® system remote control to adjust the volume and select a sound source for the room where additional speakers are in use. One option for this is the advanced PERSONAL® music center II, a combination remote control and system monitor.
- Appropriate LIFESTYLE® system cables to connect the added speaker system.

For further information, or to purchase compatible equipment, see your Bose® authorized dealer. Or, to contact Bose directly, refer to the address list provided with the system.

Making them all work together

- Use an AL8 homewide wireless audio link, which includes the two cables needed for connecting the transmitter and receiver. Instructions are included in the carton.
- Connect a Bose link speaker cable from the media center jack labeled Bose link to the audio input of the additional equipment (Figure 33).

Figure 33

Media center output connection for Bose link speakers

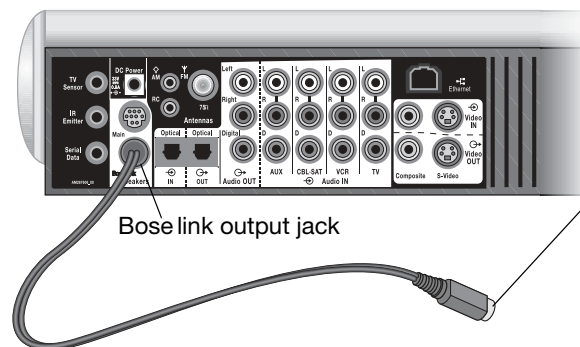

Connector marked:

Bose link A cable

Use it to connect your LIFESTYLE® system to a Bose SA-2 or SA-3 amplifier, which includes the cable.

or

Bose link B cable

Use it to connect the LIFESTYLE® system to a 3•2•1™ Series II, 3•2•1 GS Series II, 3•2•1 GSX system, or Wave® music system (cable to be purchased separately).

Accessories

Contact your Bose dealer, call Bose Customer Service, or visit www.bose.com to order the following:

- A VS-1 video expander
The Bose VS-1 provides multiple video input jacks for adding components with varied output jacks (composite, S-Video, and component). The VS-1 passes their signals through a single video output jack to the TV.
This significantly simplifies your decisions about these otherwise complex connections. It also allows you to enjoy each additional component with no need to switch the video input selection on your TV.
- A Bose® link AL8 homewide wireless audio link
This combination Wi-Fi signal transmitter and receiver enables you to enjoy your LIFESTYLE® system sound on other audio equipment in other rooms, without the bother of running wires there. You can add up to seven additional receivers, available as the Bose link AR-1 wireless audio receiver.
- Speaker mounting brackets and stands
- Additional remote controls

Contacting customer service

To contact Bose® Customer Service for help in solving problems, see the address list provided in the carton.

Limited warranty

Your LIFESTYLE® home entertainment system is covered by a transferable limited warranty. See your Product Registration card for details.

Please be sure to fill out the information section on the card and mail it to Bose. This is the only means to ensure you will receive product software update discs by mail. However, failure to return that card will not affect your limited warranty.

Technical information

Media center power pack power rating

USA/Canada: 120V \sim 0.55A 50/60 Hz 33VDC \equiv 1.1A

International: 220-240V \sim 0.30A 50/60 Hz 33VDC \equiv 1.1A

Dual voltage: 115/230V \sim 0.55A 50/60 Hz 33VDC \equiv 1.1A

Speaker system power rating

USA/Canada: 100-120V \sim 50/60 Hz 350W

International: 220-240V \sim 50/60 Hz 350W

Dual voltage: 100-120/220-240V \sim 50/60 Hz 350W

Frequency

U.S./Canada: 27.145 MHz

EU/Other: 40.685 MHz

RF Field Strength

<80dB μ V/m@ 3 meters (average)

Media center inputs

Audio IN:

- AUX: 2V_{rms}, maximum; L, R, and D (digital SPDIF)
- CBL-SAT: 2V_{rms}, maximum; L, R, and D (digital SPDIF)
- VCR: 2V_{rms}, maximum; L, R, and D (digital SPDIF)
- TV: 2V_{rms}, maximum; L, R, and D (digital SPDIF)

Video IN:

- Composite: NTSC or PAL 1V_{p-p} with sync 75 Ω
- S-Video: Luminance 1V_{p-p}, Chrominance 0.3V_{p-p}

Optical IN:

- SPDIF digital, assignable

Antenna:

- FM 75 Ω
- AM 12 μ H

TV Sensor: Scan frequency sensing

Media center outputs

Speakers Main and Expansion: Variable audio, user-selectable

Optical OUT:

- SPDIF, -15 to -21 dbm

Audio OUT:

- L and R fixed audio
- D SPDIF

Video OUT:

- Composite: NTSC or PAL $1V_{p-p}$ with sync 75Ω
- S-Video: Luminance $1V_{p-p}$, Chrominance $0.3V_{p-p}$
- Component: (combination of Composite and S-Video)

Remote control range

65 ft (20 m)

Dimensions/weights

LIFESTYLE® system media center:	15.8"W x 11.0"D x 3.5"H (40.1 cm x 27.9 cm x 8.9 cm)	8.2 lb (3.7 kg)
Cube speakers:	3.1"W x 4.0"D x 3.1"H (7.9 cm x 10.2 cm x 7.9 cm)	1.1 lb (0.5 kg)
Cube array speakers:	3.1"W x 4.0"D x 6.2"H (7.9 cm x 10.2 cm x 15.7 cm)	2.4 lb (1.1 kg)
Jewel Cube® speakers:	2.2"W x 3.2"D x 4.4"H (5.6 cm x 8.1 cm x 11.2 cm)	1.0 lb (0.5 kg)
Acoustimass® module:	8.0"W x 21.7"D x 13.0"H (20.7 cm x 55.2 cm x 33.2 cm)	26.2 lb (11.9 kg)

Finish

Media center: Brushed aluminum

Cube speakers: Polymer painted

Acoustimass module: Vinyl veneer, Polymer



094300891

BOSE[®]
Better sound through research[®]

©2006 Bose Corporation, The Mountain,
Framingham, MA 01701-9168 USA
AM294789 Rev.01