



# ***The Bose® Lifestyle® 30 Series II System***

*Owner's Guide*

*October 29, 2001*

*AM199736\_06\_V.pdf*

 **WARNING:** To reduce the risk of fire or electric shock, do not expose the system to rain or moisture.

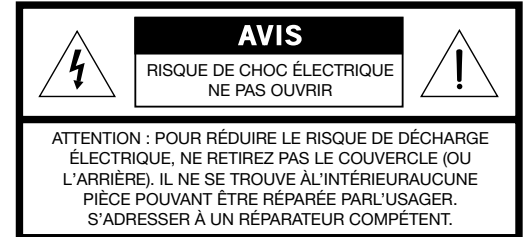
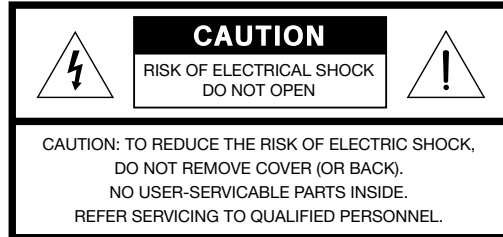

These CAUTION marks may be located on the back panel and bottom of your Lifestyle® music center and the bottom panel of your Acoustimass® module:



The lightning flash with arrowhead symbol, within an equilateral triangle, is intended to alert the user to the presence of uninsulated dangerous voltage within the system enclosure that may be of sufficient magnitude to constitute a risk of electric shock.





The exclamation point within an equilateral triangle, as marked on the system, is intended to alert the user to the presence of important operating and maintenance instructions in this owner's guide.

 **CAUTION:** To prevent electric shock, match wide blade of plug to wide slot, insert fully.

### Class 1 laser product

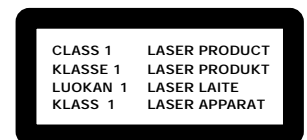
This compact disc player is classified as a CLASS 1 LASER product. The CLASS 1 LASER PRODUCT label is located on the bottom of the unit.



 **CAUTION:** Use of controls or adjustments or performance of procedures other than those specified herein may result in hazardous radiation exposure. The compact disc player should not be adjusted or repaired by anyone except properly qualified service personnel.

### Class B emissions limits

This Class B digital apparatus meets all requirements of the Canadian Interference-Causing Equipment Regulations.

### Batteries

Please dispose of used batteries properly, following any local regulations. Do not incinerate.

### Additional safety information

See the additional instructions on the *Important Safety Information* page enclosed with this owner's guide.

### Please read this owner's guide

Please take the time to follow this owner's guide carefully. It will help you set up and operate your system properly, and enjoy all of its advanced features. Save your owner's guide for future reference.

## Important Safety Instructions

1. **Read these instructions** – for all components before using this product.
2. **Keep these instructions** – for future reference.
3. **Heed all warnings** – on the product and in the owner's guide.
4. **Follow all instructions.**
5. **Do not use this apparatus near water or moisture** – Do not use this product near a bathtub, washbowl, kitchen sink, laundry tub, in a wet basement, near a swimming pool, or anywhere else that water or moisture are present.
6. **Clean only with a dry cloth** – and as directed by Bose® Corporation. Unplug this product from the wall outlet before cleaning.
7. **Do not block any ventilation openings. Install in accordance with the manufacturer's instructions** – To ensure reliable operation of the product and to protect it from overheating, put the product in a position and location that will not interfere with its proper ventilation. For example, do not place the product on a bed, sofa, or similar surface that may block the ventilation openings. Do not put it in a built-in system, such as a bookcase or a cabinet that may keep air from flowing through its ventilation openings.
8. **Do not install near any heat sources, such as radiators, heat registers, stoves or other apparatus (including amplifiers) that produce heat.**
9. **Do not defeat the safety purpose of the polarized or grounding-type plug. A polarized plug has two blades with one wider than the other. A grounding-type plug has two blades and a third grounding prong. The wider blade or third prong are provided for your safety. If the provided plug does not fit in your outlet, consult an electrician for replacement of the obsolete outlet.**
10. **Protect the power cord from being walked on or pinched, particularly at plugs, convenience receptacles, and the point where they exit from the apparatus.**
11. **Only use attachments/accessories specified by the manufacturer.**
12. **Use only with the cart, stand, tripod, bracket or table specified by the manufacturer or sold with the apparatus. When a cart is used, use caution when moving the cart/apparatus combination to avoid injury from tip-over.**
13. **Unplug this apparatus during lightning storms or when unused for long periods of time** – to prevent damage to this product.
14. **Refer all servicing to qualified service personnel. Servicing is required when the apparatus has been damaged in any way: such as power-supply cord or plug is damaged; liquid has been spilled or objects have fallen into the apparatus; the apparatus has been exposed to rain or moisture, does not operate normally, or has been dropped** – Do not attempt to service this product yourself. Opening or removing covers may expose you to dangerous voltages or other hazards. Please call Bose to be referred to an authorized service center near you.
15. **To prevent risk of fire or electric shock, avoid overloading wall outlets, extension cords, or integral convenience receptacles.**
16. **Do not let objects or liquids enter the product** – as they may touch dangerous voltage points or short-out parts that could result in a fire or electric shock.
17. **See product enclosure for safety related markings.**

## Information about products that generate electrical noise

If applicable, this equipment has been tested and found to comply with the limits for a Class B digital device, pursuant to Part 15 of the FCC rules. These limits are designed to provide reasonable protection against harmful interference in a residential installation. This equipment generates, uses, and can radiate radio frequency energy and, if not installed and used in accordance with the instructions, may cause harmful interference to radio communications. However, this is no guarantee that interference will not occur in a particular installation. If this equipment does cause harmful interference to radio or television reception, which can be determined by turning the equipment off and on, you are encouraged to try to correct the interference by one or more of the following measures:

- Reorient or relocate the receiving antenna.
- Increase the separation between the equipment and receiver.
- Connect the equipment to an outlet on a different circuit than the one to which the receiver is connected.
- Consult the dealer or an experienced radio/TV technician for help.

**Note:** *Unauthorized modification of the receiver or radio remote control could void the user's authority to operate this equipment.*

This product complies with the Canadian ICES-003 Class B specifications.



## Important Safety Instructions

18. **Use proper power sources** – Plug the product into a proper power source, as described in the operating instructions or as marked on the product.
19. **Avoid power lines** – Use extreme care when installing an outside antenna system to keep from touching power lines or circuits, as contact with them may be fatal. Do not install external antennas near overhead power lines or other electric light or power circuits, nor where an antenna can fall into such circuits or power lines.
20. **Ground all outdoor antennas** – If an external antenna or cable system is connected to this product, be sure the antenna or cable system is grounded. This will provide some protection against voltage surges and built-up static charges.

Section 810 of the National Electrical Code ANSI/NFPA No. 70 provides information with respect to proper grounding of the mast and supporting structure, grounding of the lead-in wire to an antenna discharge unit, size of grounding conductors, location of antenna-discharge unit, connection to grounding electrodes, and requirements for the ground electrode. Refer to the antenna grounding illustration on this page.

## Antenna grounding

Example of antenna grounding as per National Electrical Code, ANSI/NFPA 70.

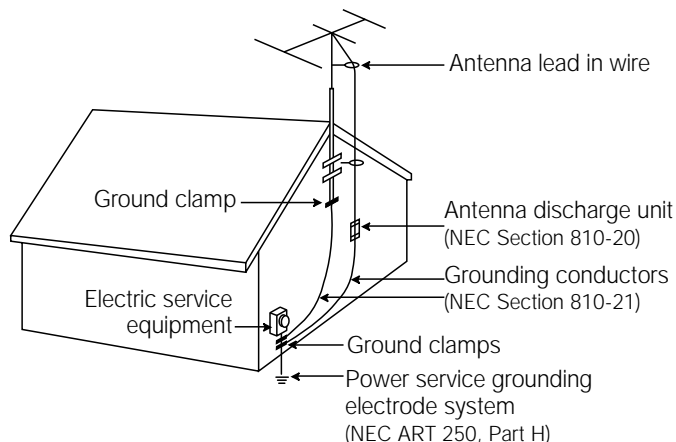

## Note to CATV system installer

This reminder is provided to call the CATV system installer's attention to Article 820-40 of the NEC (of USA) that provides guidelines for proper grounding. In particular, it specifies that the cable ground shall be connected to the grounding system of the building, as close to the point of cable entry as is practical.

**BOSE**<sup>®</sup>  
Better sound through research<sup>®</sup>

©2001 Bose Corporation,  
The Mountain, Framingham, MA  
01701-9168 USA  
255805 AM Rev.00 JN10494

**Where to find...**

Setting Up

- Before you begin ..... 4
- Unpacking the carton ..... 5
- Selecting the locations for your Lifestyle® 30 Series II system ..... 6
- Connecting the speakers and Lifestyle® music center ..... 9
- Connecting your home theater components to the Lifestyle® 30 system ..... 12
- Connecting the antennas ..... 16
- Installing the batteries in the remote control ..... 17
- Setting radio channel spacing for dual voltage and 120V systems ..... 17

Operating Your Lifestyle® 30 System

- Turning on the music center ..... 18
- The music center display ..... 18
- The music center controls ..... 19
- The Lifestyle® 30 remote control ..... 19
- The system controls ..... 20
- Additional system controls ..... 21
- Listening to your Lifestyle® 30 system ..... 22
- Operating the special features ..... 23
- Chimes ..... 23
- Listening to digital sound ..... 24
- Listening to compact discs ..... 24
- Listening to the radio ..... 27
- Using the system with external components ..... 28

Maintaining Your Lifestyle® 30 System

- Fine-tuning your system ..... 29
- Using two listening zones ..... 30
- Changing the house code settings ..... 32
- Taking care of your Lifestyle® 30 system ..... 33
- Troubleshooting ..... 34
- Warranty period ..... 35
- Customer service ..... 35

Product Information

- Technical information ..... 36
- Accessories ..... 36

Index ..... 37

Bose® Corporation ..... inside back cover

**For your records**

Serial numbers are located on the bottom of the music center and the bottom panel of the Acoustimass® module.

Music center serial number: \_\_\_\_\_

Acoustimass module serial number: \_\_\_\_\_

Dealer name: \_\_\_\_\_

Dealer phone: \_\_\_\_\_ Purchase date: \_\_\_\_\_

We suggest you keep your sales slip and warranty card together with this owner's guide.

### Before you begin

Thank you for purchasing the Bose® Lifestyle® 30 Series II system. This complete audio home entertainment system offers superb sound, elegance, technology, and simplicity for music and home theater. Your system is fully compatible with *digital* program material and includes:

- A Lifestyle® music center with built-in AM/FM radio and six-disc CD changer
- Five tiny Jewel Cube® speakers and a hideaway Acoustimass® module
- Inputs for two video sound sources, a digital sound source, and a tape deck (or other auxiliary source)
- Capability for operating two listening zones
- An easy-to-use remote control

### Realism and impact

Your Lifestyle® 30 Series II system is equipped with an all new Videostage® decoder that uses digital signal processing. The result is increased surround sound realism and impact both for movie soundtracks and music recordings. Built-in Dolby Digital decoding of inputs from DVD, digital TV, next-generation cable boxes, and satellite receivers provides “5.1” capability – up to five discrete audio channels directed into five independent Jewel Cube® speakers, plus rich bass sound from the Acoustimass module. The Videostage decoder processes analog formats, as well as two or even single-channel PCM and Dolby Digital bitstreams, and helps to deliver the acoustic experience of the movies right in your home.

### Compatibility

Your system is fully compatible with:

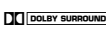
- **Digital-audio bitstreams.** Look for the symbol  or the terms Dolby Digital or PCM on DVD-Video discs. Your Lifestyle® 30 Series II system cannot process MPEG-2 or DTS digital bitstreams.
- **Surround-sound sources** such as VCRs, stereo TVs, cable boxes, and satellite receivers. Videostage decoding directs *stereo* information to the surround channels, so the sound of stereo broadcasts and rented or recorded tapes can approach that of your DVD discs.
- **Surround-encoded analog or digital audio signals.** Look for the terms Surround or Dolby Surround, or the symbol  on tapes and discs, or the word “surround” preceding a TV broadcast.
- **Stereo program material** from TV, FM, CD, and cassette. Videostage decoding delivers five channels, even when the original source contained only one or two.
- **Monoaural program material.** Videostage decoding can process a one-channel program into five-channel sound and direct the result to five independent speakers. Dialogue remains locked on-screen, while music and ambient effects fill the room.

### Automatic sound level monitoring and control

Your enjoyment of movies at home is enhanced by Digital Dynamic Range® compression. This technology automatically monitors and adjusts the volume to allow you to hear soft sounds, particularly dialogue, and to prevent you from being overwhelmed by a loud special effect (e.g., a crash or explosion). This feature is especially useful for late night movie viewing – it eliminates the need for you to constantly adjust the volume level. (See pages 22-23.)

## Unpacking the carton

Carefully unpack your system. Save all packing materials for possible future use. The original packing materials provide the safest way to transport your Lifestyle® 30 system. If any part of the product appears damaged, do not attempt to use the system. Notify Bose® or your authorized Bose dealer immediately.

Check to be sure your Lifestyle® 30 system contains the parts identified in Figure 1.

- ♪ **Note:** Find the serial numbers on the bottom panel of the Acoustimass® module and the bottom of the music center. Then write them on your warranty card and in the spaces provided on page 3.
- ⚠ **CAUTION:** Ensure the three shipping screws on the bottom of the music center are removed before turning on the system.
- ⚠ **WARNING:** The Acoustimass module weighs 33 pounds (15 kg). Use good lifting practice to avoid injury.
- ⚠ **WARNING:** To avoid danger of suffocation, keep plastic bags out of the reach of children.

**Figure 1**

What comes with your Lifestyle® 30 Series II system:

- Lifestyle® music center
- AC power (mains) pack\*
- FM antenna
- AM loop antenna
- Antenna base
- Remote control
- 3 AA batteries
- Acoustimass module
- 5 Jewel Cube® speakers
- AC power (mains) cord\*
- Audio input cable
- 5 speaker cables (3 front and 2 surround)
- 14 self-adhesive rubber feet (4 for the Acoustimass module and 5 pairs for the Jewel Cube speakers)
- Stereo cable
- CD magazine
- Lifestyle® system CD
- Test CD

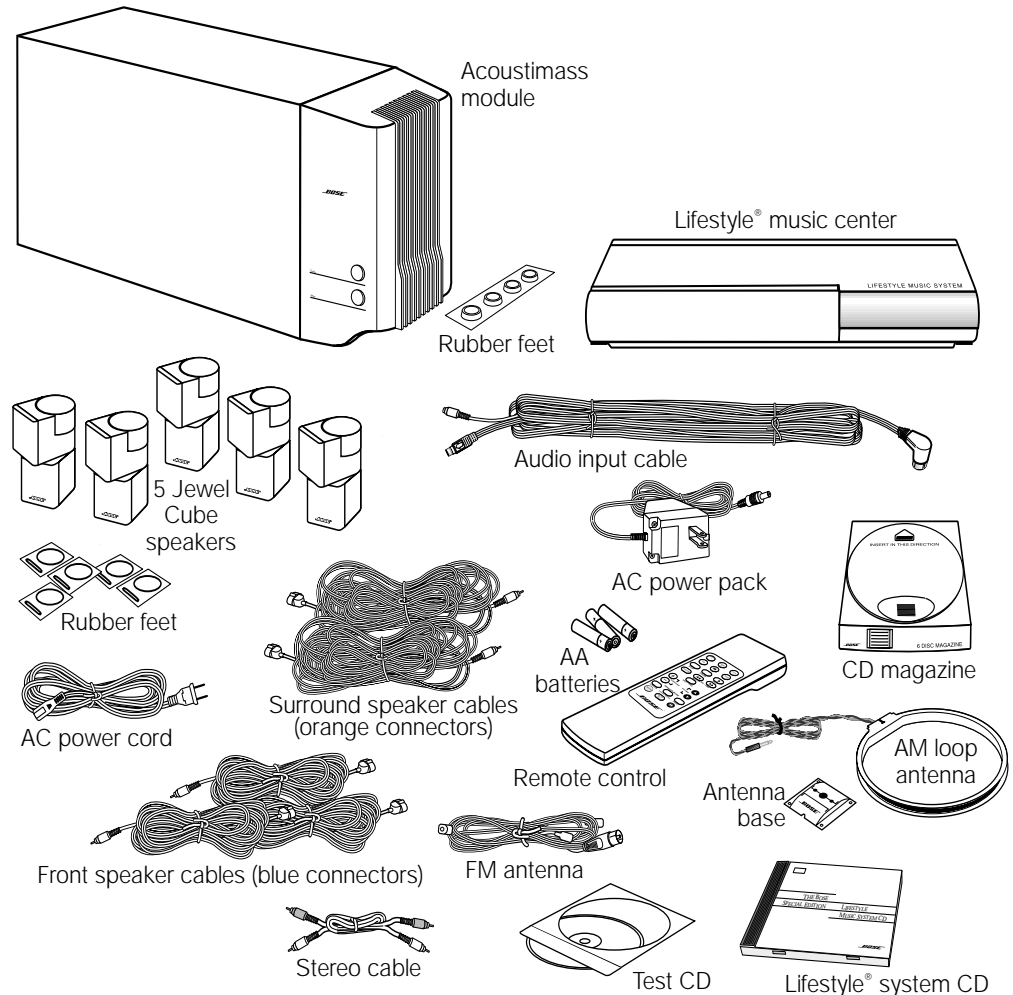

\* Power cord and pack shown above are USA/Canada versions. Dual voltage systems include 1 power cord, 1 adapter , and 2 power packs. The power cords and packs for Europe, UK/Singapore, and Australia are shown below.

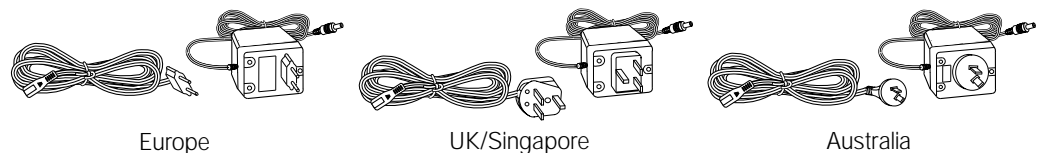

## Selecting the locations for your Lifestyle® 30 Series II system

When you place your speakers according to the guidelines below, a combination of reflected and direct sound provides the audio atmosphere of a home theater. You may experiment with the placement and orientation of the Jewel Cube® speakers to produce the sound most pleasing to you. For more discussion of speaker placement and room acoustics, see “Fine-tuning your system” on page 29.

### Jewel Cube speaker locations

Follow these guidelines to select locations that provide the maximum home theater effect from your Lifestyle® 30 system (Figures 2 and 3).



**CAUTION:** Choose a stable and level surface for your Jewel Cube speakers. Vibration can cause these speakers to move, particularly on smooth surfaces like marble, glass, or highly polished wood. For additional stability, add the provided rubber feet to your Jewel Cube® speakers.

### Left and right front speakers

The sound from the left and right front speakers should seem to appear at the edge of the picture, so that the acoustic image is close to the size of the visual image (Figure 2).

1. Place the cubes so that they line up with the center of the TV screen.
2. Place them up to 3 feet (1 m) from the edge of the TV screen.

We recommend a maximum distance of 3 feet (1 m) so that the sound does not become too separated from the picture. You may wish to vary this distance based on room conditions and personal preference. The front cables allow the cube speakers to be placed up to 20 feet (6.1 m) from the Acoustimass® module.

3. Direct one cube of each speaker forward. Direct the other cube toward the wall or in a different direction to create reflected sound. (See the illustration of reflected sound patterns in Figure 3.)



**Note:** The Jewel Cube® speakers are magnetically shielded so you can place them close to the TV without affecting picture quality.

### Center speaker

The sound from the center speaker should appear to come directly from the center of the picture (Figure 2). The center speaker cable allows up to 20 feet (6.1 m) distance from the Acoustimass module.



**Note:** Do not place the speaker on its side, as this diminishes performance by blocking the Jewel Cube ports.

1. Place the center speaker directly above or below the center of the TV screen, or at the closest convenient location.
2. Align the speaker with the front of the TV screen (not pushed to the back of the TV).
3. Direct each of the cubes slightly away from center, to create a wider area of direct sound (Figure 3).



**Note:** If you put the speakers in a bookcase unit, be sure to place each one at the front edge of the shelf. Placing speakers in an enclosed space can change the tonal quality of the sound. This effect is minimized if the shelves are filled with books.



**Figure 2**

Recommended front speaker locations

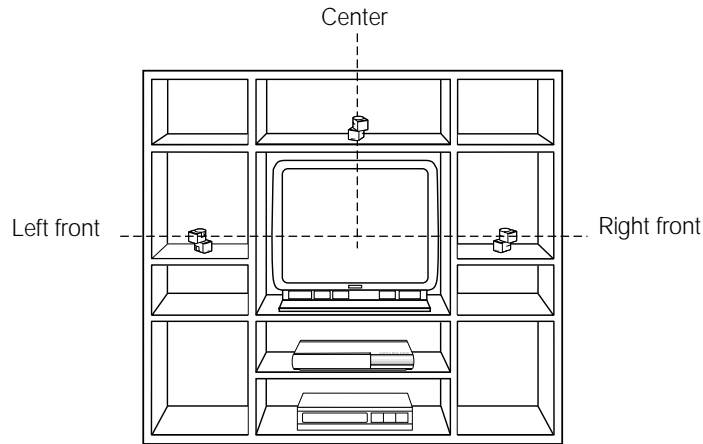

**Surround speakers**

The surround (rear) speakers create an area of sound around the listener. Place them in the back half of your room. Direct the cubes so that you cannot pinpoint the exact location of the sound source (Figure 3). The surround cables allow up to 50 feet (15.2 m) distance from the Acoustimass® module.

**Figure 3**

Speaker placement

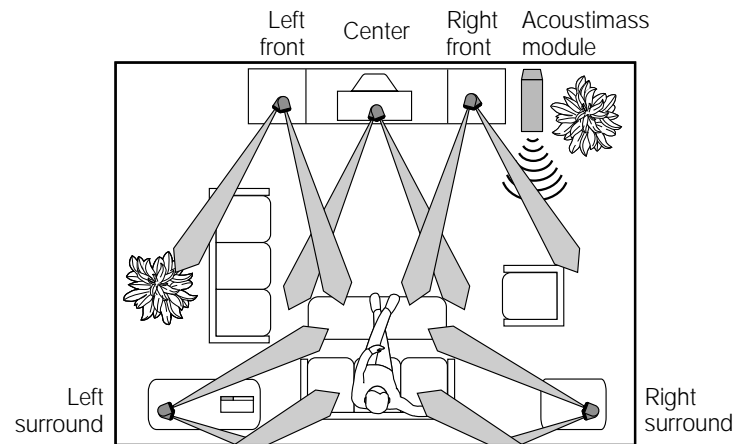

1. Place the speakers at ear height or higher, if possible.
2. Adjust the rear surround speakers to direct the sound to the front and back of the listener.

## Acoustimass® module

Follow these guidelines to select a location for the Acoustimass module.

♪ **Note:** To avoid interference with the TV picture, place the Acoustimass module at least 18 inches (45 cm) from the TV.

1. Place the Acoustimass module along the same wall as the TV, or close to the same end of the room as the front speakers (see the example along the front wall in Figure 3).
2. Select a convenient location – under a table, behind a sofa. Do not allow furniture or drapes to block the ventilation openings of the module.
3. Place the Acoustimass module within reach of the audio input cable, speaker cables, and an AC power (mains) outlet.
4. Select a position for the Acoustimass module (Figure 4). For proper ventilation, place it on the long edge, with the connectors facing the floor. An alternate position is on its largest side, with the bass and treble controls facing up. Do not place the module on either end, as shown by the last two views in Figure 4.

**Figure 4**

Acoustimass module positions

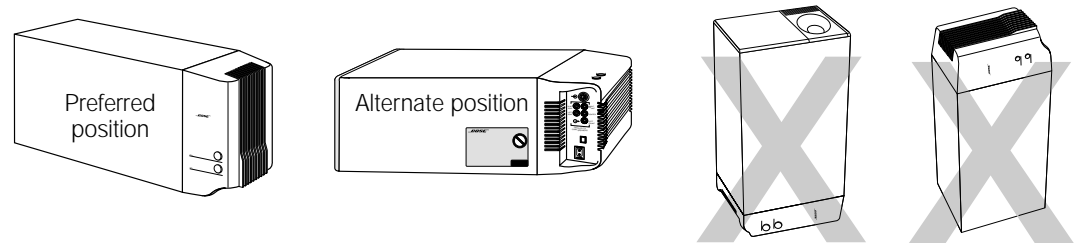

5. Once you have selected a position for the module, place the four self-adhesive rubber feet near the corners of the bottom surface. The rubber feet provide increased stability and protection from scratches.
6. Aim the port (the round opening) into the room or along the wall to avoid blocking the port or creating too much bass.
7. For best bass performance, do not place the port at equal distances from any two walls or from a wall and the ceiling.

⚠ **CAUTION:** Do not cover the ventilation openings of the Acoustimass module. The slots on the end provide ventilation for the built-in electronic circuitry, and should not be blocked.

⚠ **CAUTION:** The magnetic field from the Acoustimass module is not an immediate risk to your video tapes, audio tapes, and other magnetic media. However, you should not store tapes directly on or near the Acoustimass module.

## Music center

Select a location for the music center.

1. Allow enough room to open the CD player cover.
2. Place the music center close enough to the sound sources (TV, VCR, DVD player, etc.) to allow for cable length. If you need additional audio and/or video cables to connect all of your components, see your dealer or call Bose®.
3. Place the music center within 30 feet (9.1 m) of the Acoustimass module (the length of the audio input cable).

## Connecting the speakers and Lifestyle® music center

Once you have selected locations for your music system, connect the speakers.

**CAUTION:** Make sure all components are unplugged from the power outlet before you begin hooking up the system.

### Connecting the Jewel Cube® speakers to the Acoustimass® module

1. Match the correct cable to the corresponding speaker location.
  - Front speaker cables have blue RCA connectors at one end, with L, R, or C molded into both the RCA connectors and the Jewel Cube connectors at the other end.
  - Surround speaker cables have orange RCA connectors at one end, with L or R molded into both the RCA connectors and the Jewel Cube connectors at the other end.
2. Insert the Jewel Cube connector of each cable fully into the jack on the rear of one of the five speakers (Figure 5). Match the ridge of the connector to the notch at the top of the jack.
3. Connect each cable to the corresponding jack on the Acoustimass module.
  - a. Plug the blue connectors into the matching left front, center, and right front jacks.
  - b. Plug the orange connectors into the matching left surround and right surround jacks.

To lengthen the cable, connect speaker wire with male phono (RCA) plugs on each end to your supplied speaker cable. Use a female-to-female adapter (“barrel” connector) or splice in 18-gauge (0.75 mm<sup>2</sup>) or thicker cord (connecting + to + and – to –). To purchase extension wire, see your dealer or electronics store, or call Bose® customer service.

**Figure 5**

Speaker cable connections to the Jewel Cube speaker

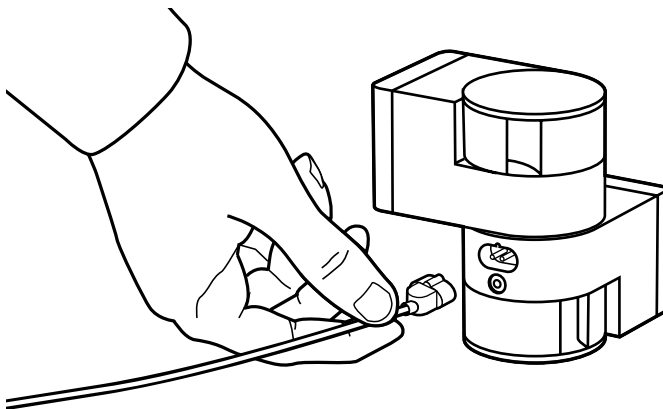

### Connecting the Acoustimass® module to the Lifestyle® music center

Connect the Acoustimass module to the music center with the audio input cable (Figure 6).

1. Plug the small black multi-pin connector (flat side facing up) into the jack marked SPEAKER ZONE 1 on the rear of the music center.
2. Insert the single right-angle multi-pin connector on the other end of the audio input cable into the AUDIO INPUT jack on the Acoustimass module. Align the connector at the angle shown in Figure 6.

♪ **Note:** Connect your digital signal source to the female RCA connector. See "Connecting your home theater components..." on page 12.

♪ **Note:** Be sure that each connector is fully inserted into each jack.

3. Extend the audio input cable as much as possible, since it includes an antenna for the remote control.

♪ **Note:** Refer to "Using two listening zones" on page 30 for information on connecting a second zone.

**Figure 6**

Music center and speaker connections

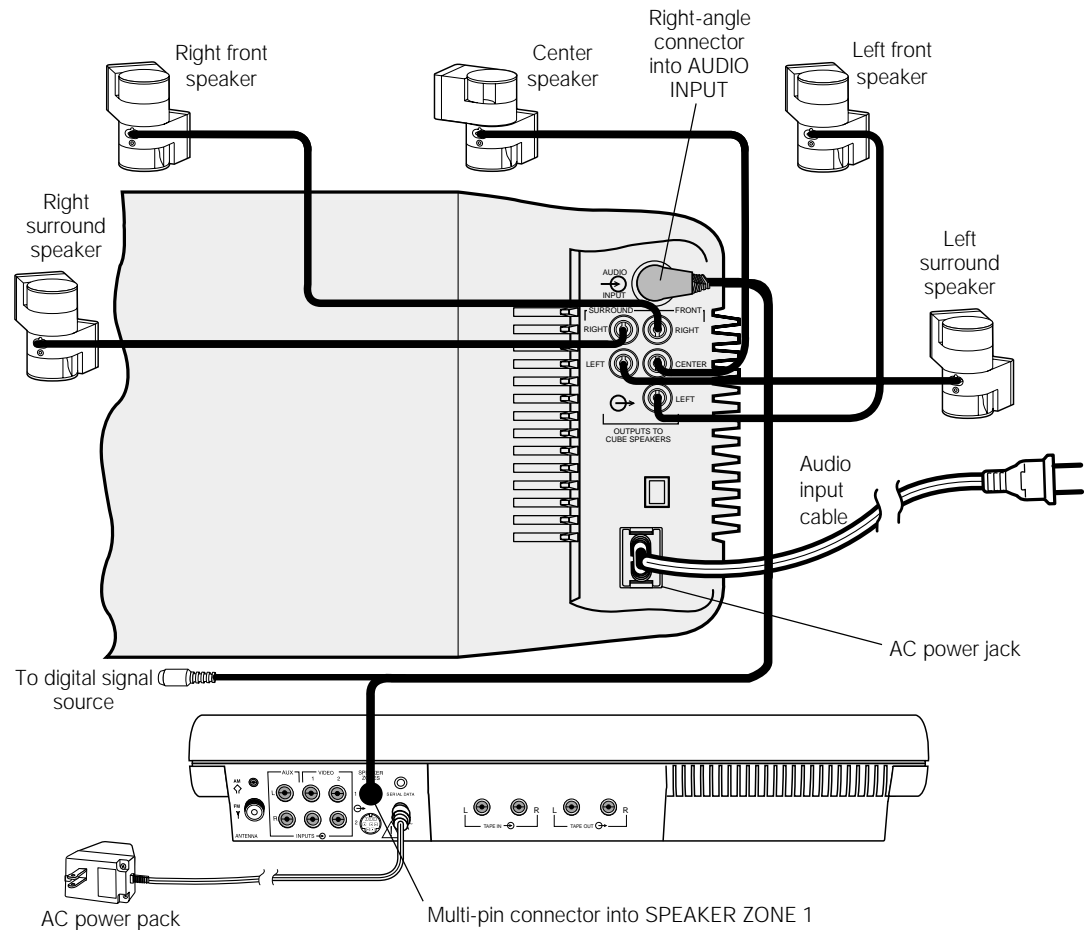

**Connecting the Acoustimass® module power (mains) cord**

1. On a dual voltage system, the voltage selector switch is preset at the factory to be correct for your area. Check to be sure it is set for the proper voltage (Figure 7). Use 115V for North America; 230V for Europe and Australia. In Europe, use the adapter plug provided. If you are in doubt, contact your local electric utility for the appropriate voltage setting.

**Figure 7**

Dual voltage Acoustimass module: voltage selector switch settings

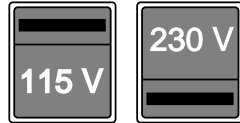

**CAUTION:** Make sure the voltage selector switch is set correctly.

2. Plug the small end of the power (mains) cord into the Acoustimass module AC power jack.



**Note:** Do **not** plug the AC power cord into a power outlet until all component connections are complete.

**Connecting the music center AC (mains) power pack**

The Lifestyle® music center comes with a 120V AC (mains) power pack for use in the USA and Canada or an appropriate 230V or 240V power pack for international use. (See Figures 1 and 8.) Dual voltage models include both 120V and 230V power packs.



**CAUTION:** Be sure to use the correct power pack for your area. Using the wrong one may damage your power pack or your music center.

- Model PS71, 120V in North America
- Model PS72, 230V in Europe
- Model PS74, 230V in UK or Singapore
- Model PS77, 240V in Australia

**Figure 8**

The AC power pack (model PS71 shown)

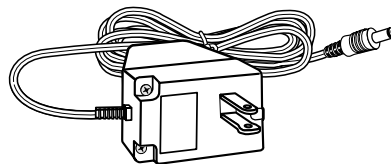

1. Firmly insert the small connector on the end of the AC (mains) power pack cable into the AC POWER jack on the back of the Lifestyle® music center.
2. Make sure that the power pack reaches an AC (mains) outlet.



**Note:** Do **not** plug the AC power pack into a power outlet until all component connections are complete.

## Connecting your home theater components to the Lifestyle® 30 system

There are many possible variations of equipment in a home theater. In addition to the Lifestyle® 30 system, a home theater complement typically includes a stereo or mono TV and stereo VCR. In a digital home theater system, the primary source may be a DVD player. Your home theater can include many other combinations of equipment, including cable TV, laserdisc players, additional VCRs, and a satellite decoder.

♪ **Note:** A mono TV only serves as a display for the video, not as a source for the audio.

In order for the Lifestyle® 30 system to provide home theater effects, the program material must be in stereo or surround-encoded, and the device playing the material must be stereo. Look for the word “surround” on the tape, CD, or preceding the TV broadcast. To hear stereo or surround sound from encoded video tapes, you must have a stereo (HiFi) VCR. While not all VCRs deliver stereo, all CD, and DVD players and nearly all laser disc players do.

♪ **Note:** Line level outputs from most VCRs or laserdisc players are fixed. If your VCR, laserdisc player, or other video sound source has fixed and variable outputs, use the fixed outputs.

### Setting up a digital sound source

Connect a DTV or DVD player’s digital signal directly to the female RCA jack on the audio input cable. Connect the DVD player’s analog signal output to the AUX inputs. If your Lifestyle® system receives a valid digital signal (including PCM or Dolby Digital bitstreams), this digital sound is used. If no valid digital signal is received, then your system selects the analog signal being sent to AUX, which is then processed by the Videostage® decoder for excellent home theater sound. If your digital audio source has an optical connector, you will need an adapter with an RCA (coaxial) connector. Consult your dealer or contact Bose®.

♪ **Note:** Ensure the connection between the digital source and the Lifestyle® system is made using a 3 to 6 foot (1 to 2 m) standard audio cable or video cable. For longer lengths, use a 75 ohm cable.

**Figure 9**

Music center connectors

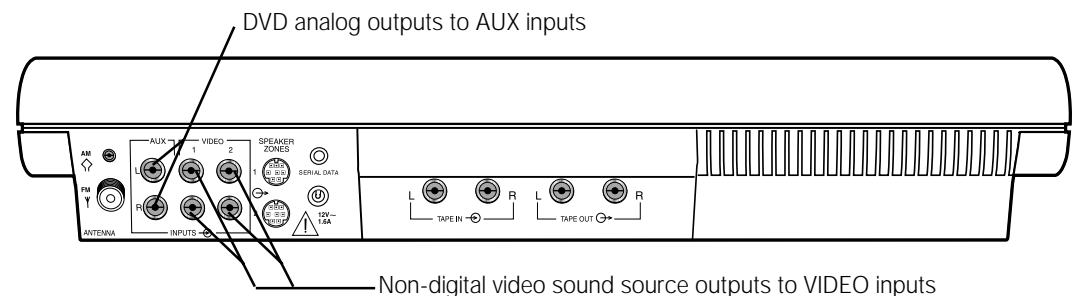

### Setting up a video sound source

The Lifestyle® 30 system has two sets of video sound inputs (Figure 9) for your non-digital video sound sources, such as your TV or VCR.

♪ **Note:** Your Lifestyle® 30 system includes one 6-foot (1.8 m) stereo cable to connect the right (R) and left (L) audio outputs from a component to the music center inputs. Cables may also be supplied with your components. If needed, audio cables are available at many electronics stores, or call Bose. Most audio cables are color coded. Match red connectors to right (R) jacks and black or white connectors to left (L) jacks.

## How to set up your home theater

There are two basic methods for setting up your home theater. It is best to connect components directly to the Lifestyle® 30 music center, and select the source from its remote or control panel. A second option is to use a stereo TV as the switching center to select the sound source. In each example, the analog outputs from the DVD player (or other digital device) are connected to the AUX inputs. You may need extra long audio cables or extensions for some of these connections.

### (1) To connect video sound sources directly to the Lifestyle® 30 system

You may connect up to three video sound sources directly to your system. For example, connect the analog outputs of your DVD player to AUX, the VCR fixed outputs to VIDEO 1, and the TV to VIDEO 2 on the back of your music center. (See Figure 10.) Connect the coaxial digital audio output from your DVD player to the female RCA connection on the audio input cable (connecting the music center with the module) using a male-to-male RCA cable.

If a valid digital signal is received by the Lifestyle® 30 system through the audio input cable, the system plays that audio source. If no valid digital signal is received, it selects the backup analog signal being sent to AUX.

When connecting your TV:

- Connect the TV fixed audio outputs to the VIDEO 2 inputs on the music center
- Turn the TV speakers off or the volume all the way down. (If there is an internal/external speakers switch, select external speakers. Do not connect any speakers to the TV.)
- Turn off any special TV settings such as expanded stereo, mega-bass, phantom, or SAP. They prevent proper surround processing through your Lifestyle® system.
- Set the TV balance control to the center of the dial or range.
- Set tone controls to flat or the middle position (neutral).
- Set TV to the stereo position.

**Figure 10**

Connecting components to the Lifestyle® 30 system inputs

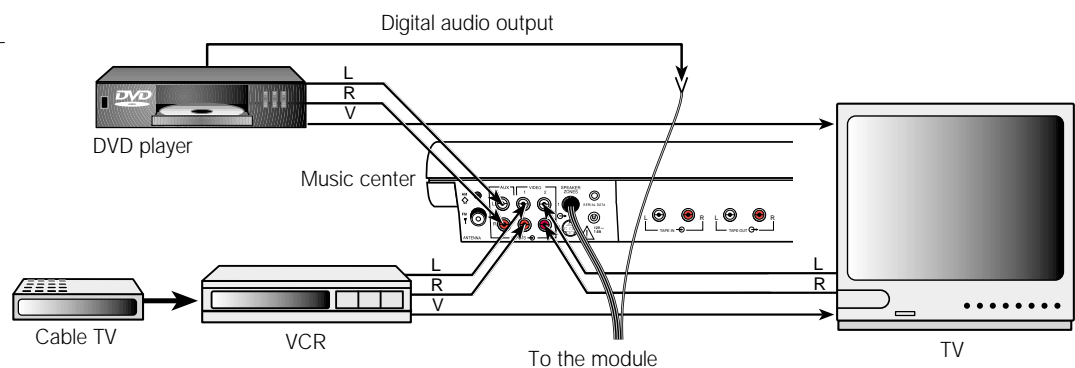

## (2) To direct video sound sources through your TV

This is an alternative connection method. (See Figure 11.) If your stereo TV has fixed audio outputs (the audio signal level doesn't change) and it allows you to select the source of the signal (VCR, laser disc, cable, etc.), then you can:

- Connect your DVD player L and R outputs to the music center AUX inputs.
- Connect the DVD video output to one of the video inputs on the TV
- Connect the coaxial digital audio output from your DVD player to the female RCA connection on the audio input cable (connecting the music center with the module), using a male-to-male RCA cable.
- Connect your home theater components to the TV inputs.
- Connect the TV fixed audio outputs to the VIDEO 1 inputs on the music center
- Turn the TV speakers off or the volume all the way down. (If there is an internal/external speakers switch, select external speakers. Do not connect any speakers to the TV.)
- Turn off any special TV settings such as expanded stereo, mega-bass, phantom, or SAP. They prevent proper surround processing through your Lifestyle® system.
- Set the TV balance control to the center of the dial or range.
- Set tone controls to flat or the middle position (neutral).
- Set TV to the stereo position.

♪ **Note:** If necessary, as a second choice, you can use the variable audio outputs from your stereo TV. Turn off or disconnect the TV's speakers and leave the volume control up – close to the maximum setting.

♪ **Note:** If you connect your stereo VCR through your stereo TV, do not use coaxial cable. Instead, connect the VCR L and R audio outputs to the TV L and R audio inputs to ensure proper stereo and surround sound.

**Figure 11**

Connecting components through your TV

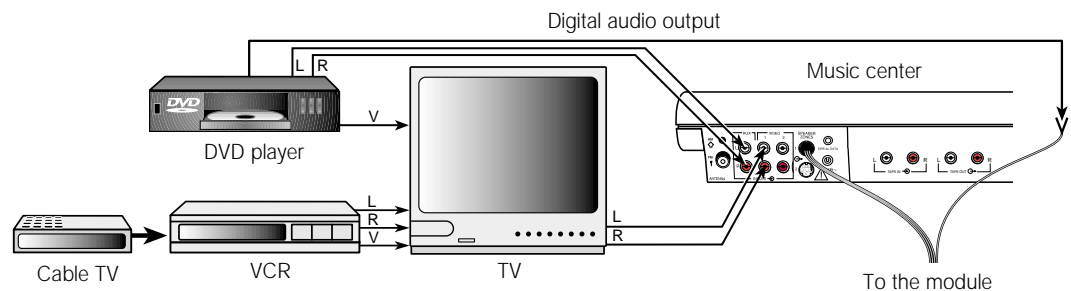



### **About the video source**

Your TV is the display for the video (picture) signal. Thus, the video signal must be connected directly to the TV. Do not connect it to the Lifestyle® 30 system.

- ♪ **Note:** For assistance with video connections between your DVD player and/or VCR and TV, see your video components manuals.
- ♪ **Note:** There is no video signal input (usually a yellow-coded jack) on the music center. The VIDEO INPUT jacks are for audio from a video source.

### **Other connections**

Use standard RCA audio cables to connect other components to your Lifestyle® music center, matching the red connector to R (right) and the white (or black) connector to L (left).

You can use a Y-adapter (available at electronics stores) to connect a mono source.

### **Tape deck**

To use an external recorder (analog audio cassette, MD, or digital audio tape), connect the inputs (REC) of the recorder to the music center's TAPE OUT jacks. Connect the outputs (PLAY) from the recorder to the music center's TAPE IN jacks.

### **Laserdisc player or additional CD changer**

To use one of these components, connect its audio outputs to the music center VIDEO 1, VIDEO 2, or AUX (if not used for a digital source) jacks, matching the red plug to R (right) and black or white plug to L (left).

### **Turntable**

To connect a turntable, you need a phono preamplifier (with RIAA equalization). You can order the appropriate model from Bose® by calling 1-800-367-4008 and asking for part number 252603. Connect the audio outputs of the phono preamplifier to the music center VIDEO 1, VIDEO 2, or AUX (if not used for a digital source) jacks, matching the red plug to R (right) and black or white plug to L (left).

- ♪ **Note:** The Lifestyle® 30 system cannot turn on or turn off a connected component.

## Connecting the antennas

The rear panel of your Lifestyle® music center provides connections for AM and FM antennas (Figure 12). Unwind each antenna's wires. Antennas provide better reception when their wires are not bundled.

**Note:** Outdoor antennas may be used with the music center antenna connections. To install an outdoor antenna, consult a qualified installer. Follow all safety instructions.

**Figure 12**

The antenna connections

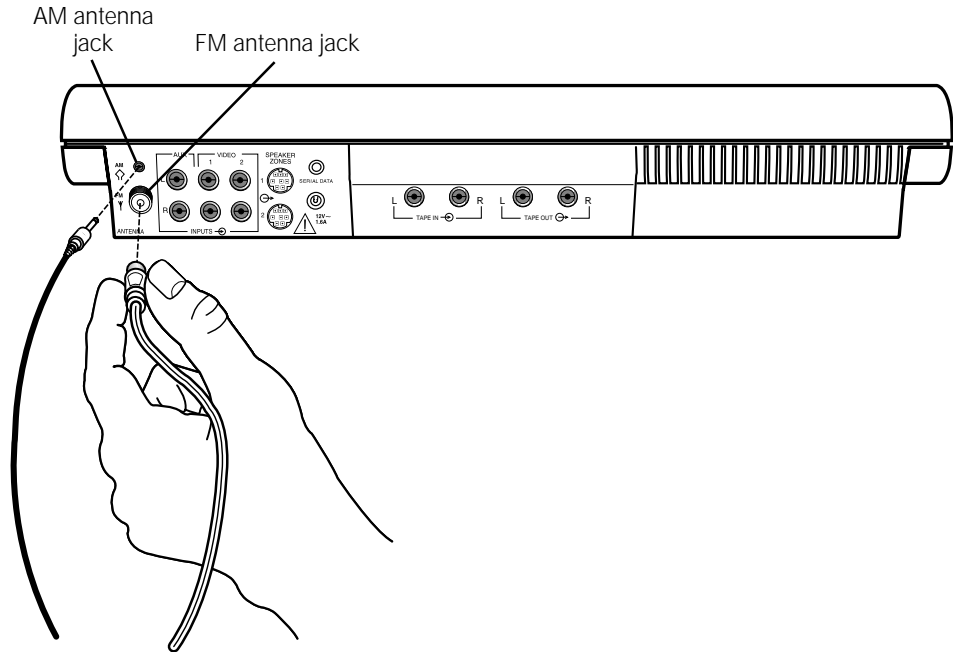

### FM antenna connections

1. Plug the antenna connector into the FM ANTENNA jack on the back of the Lifestyle® music center.
2. Spread out the antenna arms. Experiment with both the placement and the angle of this antenna to provide optimum FM reception.

**Figure 13**

The FM dipole antenna



### AM antenna connections

**Note:** To install the AM antenna on a wall, follow the instructions enclosed with the antenna.

1. Plug the AM antenna connector into the AM ANTENNA jack on the back of the Lifestyle® music center.
2. Stand the loop antenna on the base, following the instructions enclosed with the antenna.
3. Move the loop part of the antenna as far as possible but at least 20 inches (50 cm) from the music center and at least 4 feet (1.2 m) from the Acoustimass® module. Experiment with the orientation of the loop for optimum AM reception.

**Figure 14**

The AM loop antenna

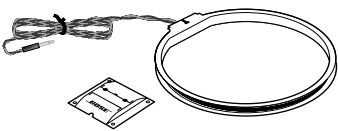

### Connecting to a cable radio signal

To connect your system to the FM signal available from some cable TV companies, contact your cable provider for assistance. The connection is made to the FM 75Ω EXTERNAL antenna connector on the back of the system.

**CAUTION:** Be certain that the installation includes a signal splitter so that only the FM band, not the cable TV band, is transmitted to the system. It is necessary to use a splitter that filters the signal to prevent any re-emissions of the TV spectrum through the system.

## Installing the batteries in the remote control

1. Slide open the battery compartment on the back of the remote (Figure 15).
2. Insert 3 AA or IEC-R6 1.5V batteries, or the equivalent, as shown. Match the + and – symbols on the batteries with the + and – markings inside the compartment.
3. Slide the battery compartment cover back into place.

Replace the batteries when the remote control stops operating or its range seems reduced. Alkaline batteries are recommended.

**Note** Do not change the settings of the factory-preset miniature switches. See “Changing the house code settings” on page 32 for information on how to prevent conflicts with other Lifestyle® music systems.

**Figure 15**

Installing the remote control batteries

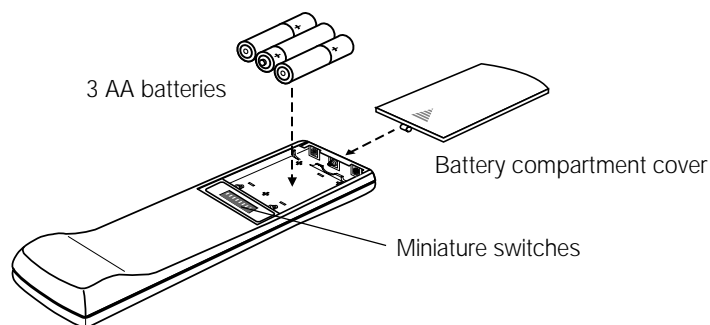

## Setting radio channel spacing for dual voltage and 120V systems

Dual voltage music centers (which include both 120V and 230V power packs) can be set for two types of AM and FM channel spacing.

- 10 kHz for AM and 200 kHz for FM (common to North America)
- 9 kHz for AM and 50 kHz for FM (common to Europe)

Your dual voltage music center is preset for North American spacing. Select the channel spacing most appropriate for your area.

To change between North American and European channel spacing:

1. Turn the music center off.
2. Press and hold the ERASE key (on the music center control panel) for three seconds. The display flashes **PROGRAM** and indicates **US** for North American spacing or **Eur o** for European spacing.
3. While holding the ERASE key, press SOURCE SELECT (on the music center control panel). The display flashes **PROGRAM** and the setting changes from **US** to **Eur o**. While holding ERASE, press SOURCE SELECT again to change from **Eur o** to **US**.

## Turning on the music center

Plug the Acoustimass® module power cord into an AC (mains) outlet. Then plug in the music center power pack.

**Note:** Your speakers will not operate unless all cable and power connections are completed before turning on the music center.

**Figure 16**

Opening the music center door

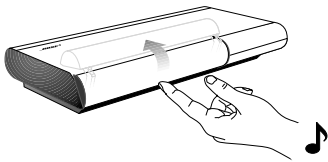

You are ready to enjoy your new Lifestyle® system. Open the music center by gently pressing upwards on the bottom of the door (Figure 16).

Refer to the pages that follow for information on operating the music center controls and the Lifestyle® remote control.

Play the Test CD, following the instructions on page 24. Listen to the instructions on the CD to verify your system setup.

**Note:** If your system will be unattended for a few days, you may want to unplug your music center to prevent a neighbor's Lifestyle® remote control or your pets from accidentally turning it on. Also see "Changing the house code settings" on page 32.

## The music center display

This music center display (Figure 17) provides information on the music center functions.

**Figure 17**

The music center display

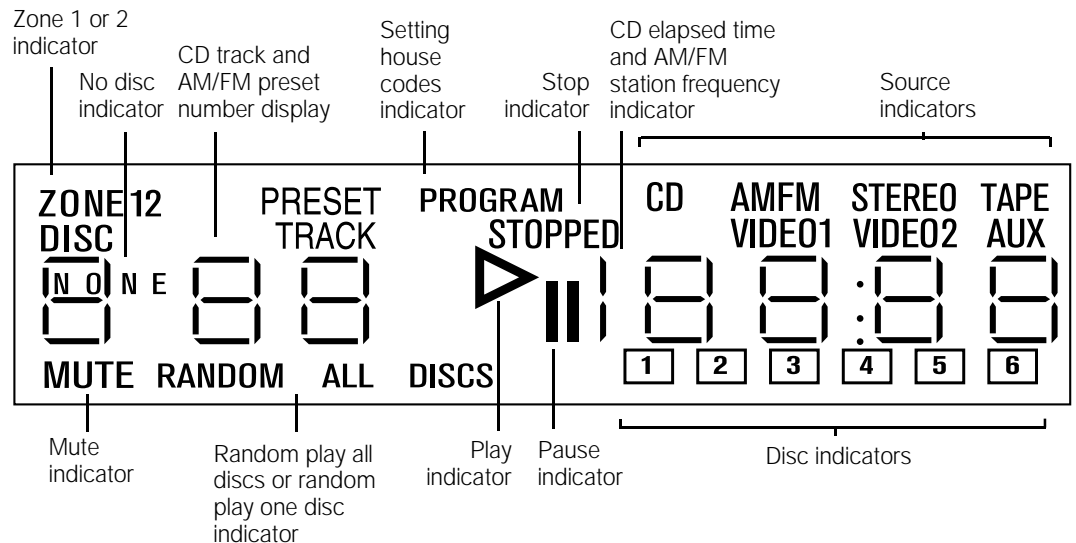

## The music center controls

The music center function keys are described on page 20. Use the following special music center keys to tune the radio, set station presets, and scan a CD (Figure 18).

**TUNE** ◀/▶ - Lowers or raises the frequency setting of the radio (stations). In CD mode, initiates a fast scan of the current CD.

**STORE** or **ERASE** - Adds or removes radio station presets. For instructions, see page 27. Also used for changing channel spacing (page 17) and house codes (page 32).

**Figure 18**

The music center controls

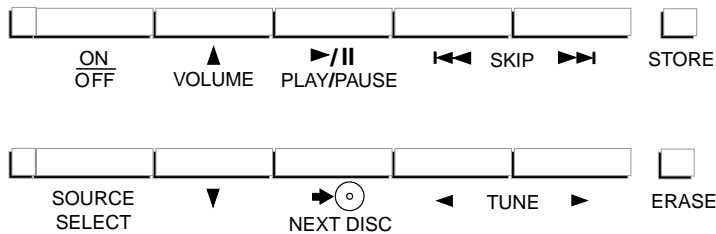

## The Lifestyle® remote control

**Figure 19**

The remote control

The advanced radio-frequency remote control works from anywhere within most types of home construction; its radio wave signals pass through walls and floors to reach the music center. Simply press the desired button. You do not need to aim the remote at the music center.







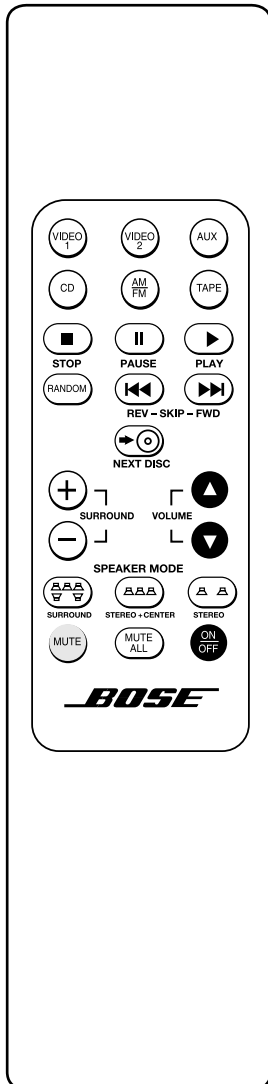









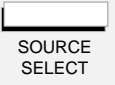





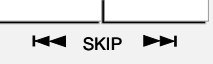



♪ **Note** Some types of buildings create “dead spots” where the remote will not operate. Simply move the remote a foot or two and try again. You can also move the music center a few feet to a location with better remote response.

Figure 19 shows the layout of the remote control.

Special buttons on the remote control select the speaker mode (5, 3, or 2 speakers), and adjust the surround (rear) volume and the center speaker volume.

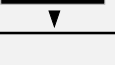



## The system controls

Function	Remote control	Music center
<b>VIDEO 1</b> - Selects a video sound source connected to the VIDEO 1 inputs, and turns the system on. (See page 22.)		
<b>VIDEO 2</b> - Selects a video sound source connected to the VIDEO 2 inputs, and turns the system on.		
<b>AUX</b> - Selects the DVD player (or other component connected to the AUX inputs) and turns the system on. Selects digital audio, if present.		
<b>CD</b> - Selects the built-in CD changer and turns the system on.		
<b>AM/FM</b> - Selects the radio and turns the system on to the previously selected station. When the radio is on, switches between AM and FM.		
<b>TAPE</b> - Selects a tape deck or other component connected to the TAPE inputs, and turns the system on.		
<b>SOURCE SELECT</b> - Turns the system on to the previously selected sound source. When on, changes the source in this sequence CD, FM, AM, VIDEO 1, VIDEO 2, AUX, TAPE, CD.		
<b>■ STOP</b> - Stops the CD player. After 20 minutes, the system shuts off.		
<b>   PAUSE</b> - Pauses play of the CD. After a 20-minute pause, changes to STOP.		
<b>▶ PLAY</b> - Begins play of the CD.		
<b>RANDOM</b> (or <b>◀◀ SKIP</b> plus <b>SKIP ▶▶</b> ) - In CD mode, begins random play of all tracks on all discs. Pressed again, begins random play of tracks on the current disc. Pressed again, cancels random play.		
<b>◀◀ SKIP</b> - Selects the previous CD track, or the previous preset radio station. Held down, initiates backward scan (CD) or seek (tuner) function.		
<b>▶▶ SKIP</b> - Selects the next CD track, or the next preset radio station. Held down, initiates forward scan (CD) or seek (tuner) function.		
<b>NEXT DISC</b> - Advances to play the next disc loaded in the CD magazine.		
<b>VOLUME ▲ \ ▼</b> - Raises or lowers the system volume.	 	 
<b>MUTE</b> - Silences the speakers in the selected zone. Also restores volume to muted speakers in the selected zone.		
<b>MUTE ALL</b> - Silences all speakers currently playing. Also restores sound to speakers silenced by the MUTE ALL key.		
<b>ON/OFF</b> - Turns the system on and off.		

 **Note** For information on controlling the system from different zones, see "Using two listening zones" on page 30.

## Additional system controls

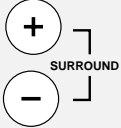
Function	Remote control
<p><b>SURROUND</b></p> <ul style="list-style-type: none"> <li>• Press and release to select SURROUND (5-speaker) mode for all sources.</li> <li>• Press and hold for 3 seconds to engage (1 chime) or disengage (2 chimes) simulated surround for monaural program sources.</li> <li>• Press and hold for 8 seconds to restore (3 chimes) factory settings for speaker mode and surround volume level.</li> </ul>	 <p>SURROUND</p>
<p><b>STEREO+CENTER</b></p> <ul style="list-style-type: none"> <li>• Press and release to select STEREO+CENTER (3-speaker) mode for all sources.</li> <li>• Press and hold for 8 seconds to restore (3 chimes) factory settings for speaker mode and center volume level.</li> </ul>	 <p>STEREO+CENTER</p>
<p><b>STEREO</b></p> <ul style="list-style-type: none"> <li>• Press and release to select STEREO (2-speaker) mode for all sources.</li> <li>• Press and hold to engage (1 chime) or disengage (2 chimes) Digital Dynamic Range® compression.</li> </ul>	 <p>STEREO</p>
<p><b>SURROUND + / -</b></p> <ul style="list-style-type: none"> <li>• In SURROUND (5-speaker) mode, raises or lowers volume of surround speakers.</li> <li>• In STEREO+CENTER (3-speaker) mode, raises or lowers volume of center speaker.</li> <li>• In STEREO (2-speaker) mode, + selects the SURROUND mode.</li> </ul> <p><b>Note:</b> The adjustments made with SURROUND + and - will be remembered even if you select another speaker mode.</p>	 <p>SURROUND</p>
<p><b>Note:</b> If you set the master volume level very high or very low, a built-in feature automatically resets it to the threshold level the next time the system is turned on.</p> <p><b>Note:</b> To restore all factory default settings, turn power off then on, press and hold the SURROUND (5-speaker) button until you hear the 3-chime confirmation tone, then press and hold the STEREO+CENTER (3-speaker) button until you hear the 3-chime confirmation tone.</p>	

## Listening to your Lifestyle® 30 system

Your Lifestyle® 30 system uses digital signal processing to bring even greater realism and impact to both movies and music recordings. Built-in Dolby Digital decoding delivers up to 5.1 discrete audio channels (i.e., five for the independent Jewel Cube® speakers and one for rich bass from the Acoustimass® module) from DVD, digital TV, next-generation cable boxes, and satellite receivers. With analog formats, as well as for two-channel PCM and Dolby Digital bitstreams, Videostage® decoding directs stereo information to the surround channels, so the sound of stereo broadcasts and rented or recorded tapes can approach that of your DVD discs.

In addition, Videostage decoding processes a one-channel program and directs five-channel sound to five independent speakers. Dialogue remains locked on-screen, while music and ambient effects fill the room to increase your listening enjoyment.

Your Lifestyle® 30 system offers the option of listening in 5, 3, or 2-speaker mode. The system turns on in SURROUND (5-speaker) mode. For most video material (mono, stereo, or surround), listening in 5 or 3-speaker mode helps anchor the dialogue to the picture while providing a fuller sound.

### Using enhanced mode for movie soundtracks

Pressing VIDEO 1, VIDEO 2, or AUX turns the system on in enhanced mode, with bass and treble settings specially designed for proper playback of movie soundtracks. Press the same button (VIDEO 1, VIDEO 2, or AUX) again to alternate between enhanced mode for movies and standard mode for other listening. Pressing TAPE turns the system on in standard mode. Press TAPE again to alternate between enhanced mode for movies and standard mode for other listening.

♪ **Note:** *Enhanced mode provides more bass and less treble, as is specified for proper playback of movie sound.*

### Digital Dynamic Range® compression

Digital Dynamic Range compression automatically adjusts the volume to allow you to hear soft sounds (particularly dialogue) and to prevent you from being overwhelmed by a loud special effect (e.g., an explosion). This feature is engaged when you turn on the system, but you may turn it on (one chime) or off (two chimes) using the STEREO  two-speaker button.

### Using simulated surround for mono movie material

Bose® Videostage decoding can process a one-channel program into five-speaker sound – directing the signals so that dialogue remains locked on-screen, while music and ambient effects fill the room. You experience a surround sensation, providing extra enjoyment when you watch older (i.e., pre-stereo) movies. This feature can be used for mono TV, FM, and AM programs. Press the SURROUND  (5-speaker) button to turn it on (one chime) or off (two chimes). This feature is automatically engaged when a Dolby Digital bitstream indicates that it contains a mono program.



## Operating the special features

Please see the previous page for a more detailed explanation of these special features.



### Enhanced mode

<b>When you select</b>	<b>The mode is</b>	<b>To change this</b>
VIDEO 1, VIDEO 2, or AUX TAPE	Enhanced Standard	Press the same button again Press the same button again
CD or AM/FM	Standard	Not applicable: You cannot select enhanced mode for CD or AM/FM

### Digital Dynamic Range® compression

<b>When you select</b>	<b>Compression is</b>	<b>To change this</b>
VIDEO 1, VIDEO 2, or AUX	ON	Press and hold the STEREO  (2-speaker) button until two chimes are heard
CD, AM/FM, or TAPE	OFF	Press and hold the STEREO  (2-speaker) button until one chime is heard

### Simulated surround (monaural into 5 speakers)

<b>When your audio source is</b>	<b>Simulated surround is</b>	<b>To change this</b>
Mono Dolby Digital	ON	Press and hold the SURROUND  (5-speaker) button until two chimes are heard (OFF)
Anything else	OFF	Press and hold the SURROUND  (5-speaker) button until one chime is heard (ON)

### To return speaker levels to factory settings

<b>To reset</b>	<b>Press</b>
Center speaker level	STEREO+CENTER  (3-speaker) button until you hear a 3-note chime
Surround (rear) speakers level	SURROUND  (5-speaker) button until you hear a 3-note chime

## Chimes

When you hear one or more chimes, it means that one of the system features has been turned on or off.

### What the chimes mean

<b>When you hear</b>	<b>This means</b>
1 chime	Simulated surround (monaural into 5 speakers) <i>or</i> Digital Dynamic Range® compression has been turned ON
2 chimes	Simulated surround (monaural into 5 speakers) <i>or</i> Digital Dynamic Range® compression has been turned OFF
3 chimes	Surround speaker level <i>or</i> Center speaker level has been restored to factory default settings

## Listening to digital sound

### Turning on the digital audio source

Turn on the DVD player, DTV, or other digital audio source. Load the DVD disc.

### Turning on the system and choosing digital sound

Press AUX to turn your system on to play digital sound. If your Lifestyle® system does not receive a valid PCM or Dolby Digital bitstream, it will automatically select the analog signal connected to the music center AUX jacks.

### Selecting listening material

To select material with compatible digital-audio bitstreams, look for the terms PCM or Dolby Digital, or the symbol  on DVD-Video discs. Your Lifestyle® 30 system cannot process MPEG-2 or DTS digital bitstreams. Make sure a connection is made between your DVD player or Digital TV's digital audio output and your system's digital audio input.

To select surround-encoded analog or digital audio material, look for the terms Surround or Dolby Surround, the symbol  on tapes and discs, or the word "surround" preceding a TV broadcast. You can listen to any program material in SURROUND (5-speaker) mode, though you may not hear sound from all five speakers all the time. Some monaural and stereo materials will not cause sound to be directed to the surround speakers. Even with surround-encoded material there are times when no sounds are directed to the surround speakers.

## Listening to compact discs

### Using the CD changer

You can load up to six compact discs at a time.

### Loading discs into the CD magazine

Hold the magazine, looking at the side with the arrow. Insert up to six discs, label side up (Figure 20). Take care to place only one disc in each slot. Note the slot numbers 1 through 6, from bottom to top, on the front edge window. These numbers correspond to the CD numbers on the display.

 **Note:** If a disc is upside-down, it does not play. The display shows the word "disc" and flashes the box representing that disc.

 **CAUTION:** Do not insert more than one disc into any slot. Forcing two discs into one slot could cause them to become stuck, and could damage the discs, the CD magazine, or the music center.

**Figure 20**

Loading a CD

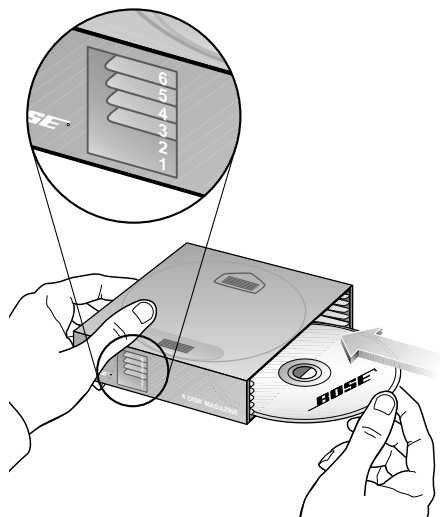

**Ejecting discs from the CD magazine**

Press the white lever that corresponds to the disc you want to eject. This ejects the disc far enough for you to grasp the edge and remove it from the magazine (Figure 21).

**Figure 21**

Ejecting a CD

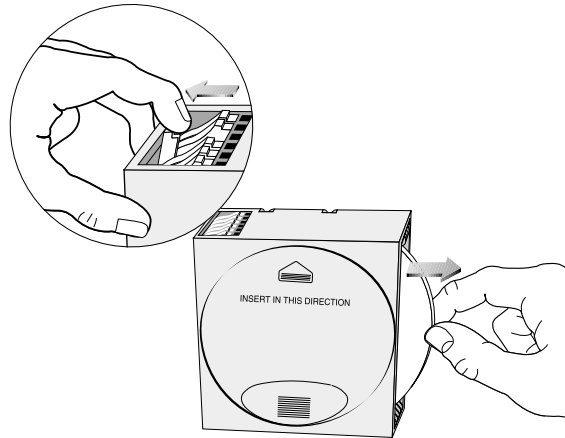

**Loading the CD magazine into the music center**

Open the music center door. Insert the CD magazine fully into the music center, following the direction of the arrow on the magazine (Figure 22).

**Figure 22**

Loading the CD magazine

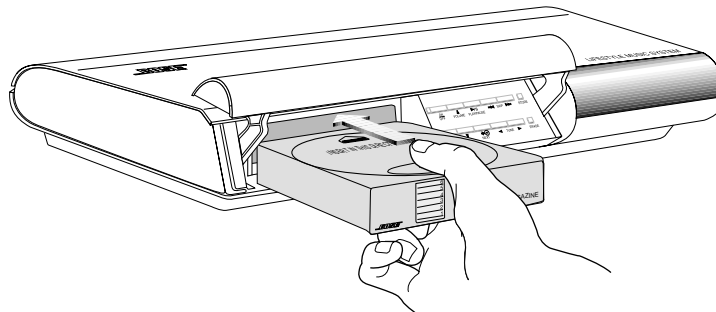

**Ejecting the CD magazine from the music center**

Press the EJECT button, at the lower left of the magazine slot, to remove the magazine (Figure 23). If a CD is playing, pressing the EJECT button stops the CD, replaces it in the magazine, and ejects the magazine.

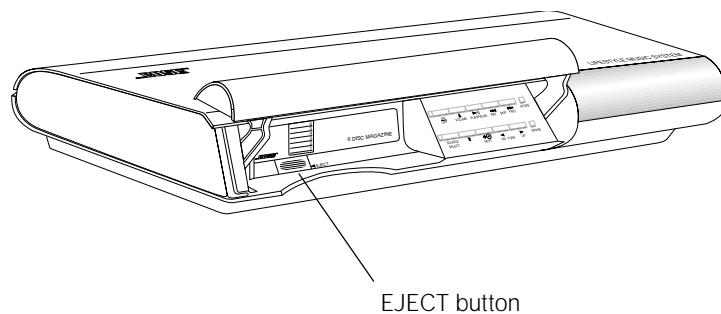

**Figure 23**

The CD magazine EJECT button



### Turning on the system and choosing the CD player

Press the CD key on the remote or press SOURCE SELECT on the music center until CD is selected. If the system is already on, use one of these keys to select the CD player. The CD indicator on the display lights. If a CD has been loaded, it begins to play.

**Note:** Selecting CD turns the system on in SURROUND (5-speaker) mode. Press STEREO+CENTER  (3-speaker) or STEREO  (2-speaker) to change the mode.

### CD operations

#### If you want to

- Play or resume play of a CD
- Pause a CD
- Stop a CD
- Go to next track
- Go to beginning of current track
- Go to previous track

#### Press

- ▶ PLAY, or ▶/|| PLAY/PAUSE
- || PAUSE, or ▶/|| PLAY/PAUSE
- STOP, or select another source
- SKIP▶▶ (forward)
- SKIP◀◀ (reverse) after 4 seconds of track play
- SKIP◀◀ within the first four seconds of the track. After four seconds, press SKIP◀◀ twice to go to the previous track. In RANDOM mode, skips to previous track played.
- ▶⊙ NEXT DISC  
In PLAY mode, selects discs in order, 1 through 6, then back to 1; in RANDOM mode, randomly selects another disc. The music center skips empty disc slots.
- Press and hold SKIP◀◀ or ▶▶, or TUNE◀ or ▶
- RANDOM, or SKIP◀◀ plus ▶▶ (on the music center)
- RANDOM, or SKIP◀◀ plus ▶▶ (on the music center), a second time
- RANDOM, or SKIP◀◀ plus ▶▶ (on the music center), a third time; press ■ STOP; or select another source

**Note:** To prevent excessive wear on the CD mechanism, unattended CD play or random play operations change to STOP after 24 hours. If you want to leave the music center playing unattended for longer than 24 hours, you can use the radio.

**Figure 24**

Display of CD playing in zone 1:  
Disc 3, track 8, 2 minutes and 45 seconds played, 6 CDs are loaded, and random play for all discs is selected

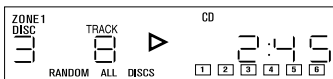

The music center display provides the following information about the CD changer functions (see sample display in Figure 24):

- Which CD is playing, paused, or stopped, or NONE if no disc is installed
- How much time the current CD has played
- Which track is playing
- If RANDOM ALL DISCS or RANDOM (one disc) is selected
- Which slots have been scanned and have discs loaded
  - Numbers in boxes represent discs in slots.
  - Empty boxes indicate disc slots that have not yet been scanned by the music center.
  - Blank spaces indicate empty slots (or discs that cannot be loaded).
  - A flashing box indicates the disc is upside down or cannot be read.

## Listening to the radio

### Turning the system on and choosing the radio

Press the AM/FM key on the remote or the music center to turn your music system on to the most recently heard AM or FM station. The system turns on in SURROUND mode. Select another speaker mode, if desired.

**Note:** If the system is on and the radio is already selected, this key switches between the AM and FM bands.

### Tuning

#### Seeking the strongest stations

- Press and hold SKIP ►► (forward) or ◄◄ (reverse) to start seeking. Release the key to stop at the next strong signal.
- To stop seeking sooner, briefly press SKIP or ■ STOP.
- You can seek again without holding down the SKIP key. As soon as the first seek operation stops, briefly press the SKIP ►► or ◄◄ key.

#### Switching between AM and FM

Press the AM/FM key to switch to the other band.

#### Manual tuning

To tune to a distant or weak station that the radio cannot seek, use TUNE◄ or ► on the music center.

#### Setting a station preset

Your Lifestyle® music center can store up to 25 AM and 25 FM stations in any combination.

**Note:** To allow for different station preferences, you can reserve a group of preset numbers for each household member. Any station can be assigned to more than one preset number. Or, you can reserve different number groups for different types of stations. For easy reference, you may want to keep a written record of your presets.

1. Lift the music center door.
2. Select a radio station you want to store as a preset, either by tuning manually or by pressing and holding a SKIP key.
3. Press the STORE key. The lowest available preset number flashes for three seconds, then is set and displayed.
4. If you prefer a different preset number, while the number is flashing press either SKIP key to select another available preset number. The preset number is displayed.

**Note:** You cannot store a station in an already-occupied preset location without erasing that preset station first (see "Erasing a preset station" below). If you attempt to store more than 25 AM or 25 FM stations, the preset display will flash '— —'.

#### Selecting a preset station

Once you have set station presets, press SKIP ►► or ◄◄ to select the next or the previous preset station. See Figure 25 for a sample display of a preset FM station.

#### Erasing a preset station

1. Lift the music center door.
2. Select the preset station you want to erase.
3. Press the ERASE key.

**Figure 25**

FM display showing a preset station

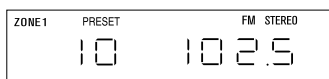

## Using the system with external components



Follow the instructions on pages 12-15 for connecting components.

Turn on your component directly or by using its remote control. Use the VOLUME ▲ or ▼ button on the Lifestyle® remote control or music center to raise or lower the volume. Control all other functions at the source, referring to its owner's manual, if necessary. To begin, make sure the component is turned on and a tape, CD, DVD, laserdisc, etc. is loaded.

♪ **Note:** *The Lifestyle® 30 system cannot turn a connected component on or off.*

### Turning the system on and selecting the component

Press the TAPE, AUX, VIDEO 1, or VIDEO 2 button on the remote or press SOURCE SELECT on the music center until the desired component is selected. This turns your system on and selects the component connected to that input. If the system is already on, this button selects the component.

♪ **Note:** *Selecting a source turns the system on in SURROUND (5-speaker) mode. Press STEREO+CENTER  (3-speaker), or STEREO  (2-speaker) to change the mode.*

The appropriate display indicator lights when the system is on and the component is selected.

### Using a video sound source

Press VIDEO 1 or VIDEO 2 on the remote or SOURCE SELECT on the music center until VIDEO 1 or 2 appears on the display. This turns your system on in SURROUND (5-speaker) mode and selects the video sound source connected to the VIDEO 1 or 2 jacks.

If your video component is connected to the music center TAPE jacks, press TAPE on the remote or SOURCE SELECT on the music center until TAPE appears on the display. This turns your system on in SURROUND (5-speaker) mode and selects the source connected to the TAPE jacks.

### Using enhanced mode for movie soundtracks

When a movie soundtrack is played in a motion picture theater, its bass and treble are restored to the original levels intended by the movie's sound designer. To re-create the same performance in your home, your Lifestyle® 30 system's enhanced mode restores the bass and treble to these levels when you select VIDEO 1, VIDEO 2, or AUX.

When VIDEO 1, VIDEO 2, or AUX is selected, you can also choose between standard and enhanced modes. The system turns on in enhanced mode for movies. Press the same button (VIDEO 1, VIDEO 2, or AUX) again to change to standard mode. When TAPE is selected, the system turns on in standard mode. Press TAPE again to change to enhanced mode for movies.

♪ **Note:** *You may not hear a difference between enhanced and standard modes when listening to dialogue or other program material that does not have much bass or treble.*

### Using a tape deck

To record to a connected tape deck, play the source (AM/FM, CD, AUX, VIDEO 1 or 2) you want to tape. In a 2-zone system, play the source in zone 1. Set the tape deck to record.

### Using headphones

For headphone listening, use the stereo mini headphones jack on the side of the music center (Figure 26). While this jack accepts most headphone models, you can get an adapter at Bose® dealers and most electronics stores, if needed.

Connecting headphones silences the speakers connected to SPEAKER ZONE 1.

**Figure 26**

Connecting headphones

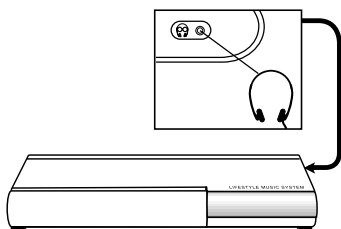

## Fine-tuning your system

**Figure 27**

Bass and treble controls

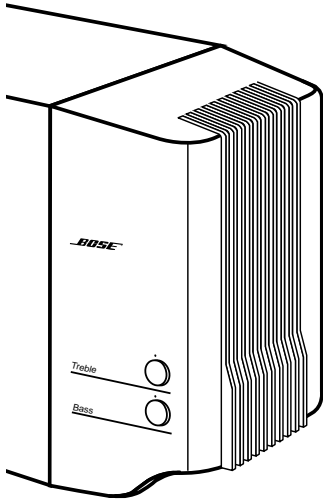

In most situations, following the speaker placement guidelines (see pages 6-8) provides excellent sound quality.

You do not need to adjust tone settings for changes in volume, since Bose® patented signal processing technology provides a natural tonal balance over the full range of volume settings. If desired, you can further fine-tune your system as described below.

### **Adjusting speaker controls**

The Lifestyle® 30 system TREBLE and BASS controls are located on the Acoustimass® module (Figure 27). They allow you to adjust the treble (high frequencies) and bass (low frequencies). In the normal setting, the dots on each control are in the 12 o'clock position. You can also locate the normal setting by feeling when the control settles into the notch at this position. Turn the controls clockwise to increase, and counterclockwise to decrease, the amount of treble or bass.

### **Compensating for room acoustics**

The acoustics (sound qualities) of your room can affect the overall sound quality of any speaker system. In general, you can reduce many problems with acoustics by the cautious use of the TREBLE and BASS controls.

#### **Too much or too little treble**

Rooms with too few sound-absorbing furnishings, especially those with bare floors and walls, may sound overly shrill or "bright." Turning down the treble control (toward -) decreases treble sound.

Rooms with a lot of sound-absorbing furnishings, such as upholstered furniture, wall-to-wall carpet, or heavy drapes, may reduce the treble sound of your system. Moving speakers farther away from soft furnishings increases treble. You can increase treble sound by slightly turning up the treble control (toward +).

#### **Too much or too little bass**

You can decrease bass sound by turning down the bass control (toward -). To increase bass, turn up the bass control (toward +).

Acoustimass module placement affects the amount of bass you hear. Placing the module closer to the corner of the room will increase bass. Moving the module away from the corner will decrease bass.

## Using two listening zones

**Figure 28**

Example of two listening zones: the Lifestyle® 30 speakers in zone 1 and Acoustimass® powered speaker system in zone 2

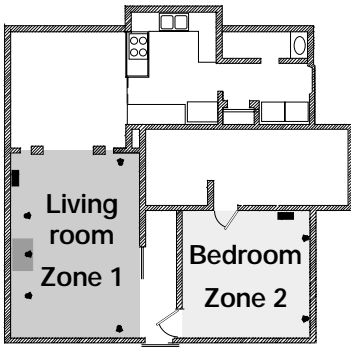

The Lifestyle® 30 system can direct sound from one or two sound sources to two different listening areas at the same time. Each listening area, whether a room or a group of rooms (including outdoor areas), is referred to as a zone. By adding powered speakers and a second remote, you can establish two listening zones (Figure 28).

### How zones work

- Zones 1 and 2 can play the same or different sound sources at the same time – CD, AM/FM tuner, TAPE, VIDEO sound, or AUX.
- Only one radio station can be played at a time.

### Setting up two zones

- The Lifestyle® 30 speakers are set up in zone 1.
- Any combination of rooms and floors in your home can be set up as zones.
- Use an appropriate Lifestyle® system cable to connect a second Bose® powered speaker system to the SPEAKER ZONE 2 jack on the back of the music center.
- You can also use special adapters to connect an existing stereo system.
- Use a second Lifestyle® system remote control to operate zone 2.

See your dealer or contact Bose for information on obtaining additional powered speakers, remote controls, cables, and adapters for connecting additional equipment.

### Setting a second remote for zone 2

You need a second remote control, set to ZONE 2, to operate speakers connected to the ZONE 2 output.

To set your second remote to control speakers in the second zone, follow these steps:

1. Open the remote control battery cover.
2. Locate miniature switch 8 (Figure 29). If it is set *down* for ZONE 1, slide it *up* for ZONE 2, using a paper clip, ballpoint pen, or similar object.
3. Make sure the house code switches (1, 2, 3, and 4) match those on your first remote. (See page 32 for more information on house codes.)
4. Replace the battery cover.

**Figure 29**

Speaker code switch settings

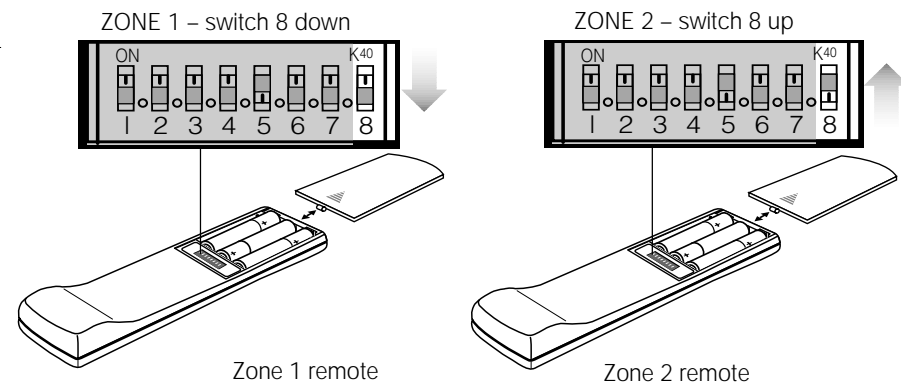



## Operating two listening zones

### Controlling the zones from the remote controls

To control two zones, you need to have a remote set to each zone. See instructions on page 30 for setting a second remote to zone 2.

- You can select and control sources in each zone by commands from its remote control.
- You can control the volume in each zone directly from its remote control.
- You can turn each zone on and off directly from its remote control.
- You can listen to the same source in both zones.

### Controlling the zones from the music center control panel

Turning two zones on and off from the music center involves a sequence of actions.

- To turn zone 2 on from the music center, press and hold the ON/OFF key. Watch the display to see which zone is on or off. Release the key to keep the option shown.

Holding the ON/OFF key causes this repeating sequence:

	<b>zone 1</b>	<b>zone 2</b>
First	ON	OFF
Second	ON	ON
Third	OFF	ON

- To turn the zones on or off from the music center when both zones are on, press the ON/OFF key for the following sequence:

	<b>zone 1</b>	<b>zone 2</b>
	ON	ON
First press	OFF	ON
Second press	OFF	OFF
Third press	ON	OFF
Fourth press	OFF	OFF
Additional presses	zone 1 repeats ON and OFF	

- When zone 1 is on (even if zone 2 is also on), the music center keys control zone 1 only.
- When zone 2 is the only zone on, the music center keys control zone 2.
- If you press SOURCE SELECT for FM or AM while zone 2 is playing the other radio band, the band selected in zone 2 flashes on the display. If you do not want to change the band playing in zone 2, use SOURCE SELECT to choose another source within two seconds.

### The music center display of zone information

- When zone 1 or both zones are on, the display shows zone 1 information.
- When only zone 2 is on, the display shows zone 2 information.

## Changing the house code settings

Each Lifestyle® remote control uses a system of matching house codes to communicate with its corresponding music center. If your remote's commands ever conflict with those of another nearby Lifestyle® system, you can easily set a new house code for your system and its remote control(s) by following the procedures below.

1. Open the remote control battery cover and locate the miniature switches (Figure 30).
2. To create a new code, change the position of switches 1, 2, 3, or 4 by moving them in the opposite direction from their current settings. Use a paper clip, ball point pen, or similar object.

♪ **Note:** Do not change switches 5, 6, or 7 at this time. The manufacturer's standard setting is switch 5 up and switches 6 and 7 down.

3. Replace the battery cover.

**Figure 30**

Miniature switches for setting house codes and zones

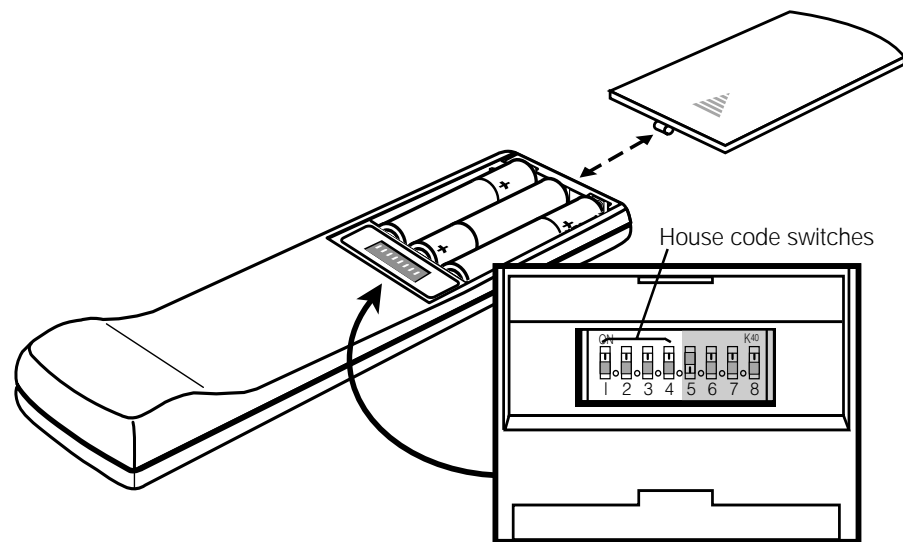

4. Lift the music center door.
5. Turn both zones off.
6. Press and hold the STORE key. The display will begin to flash PROGRAM.
7. While you hold the STORE key and the display is flashing, press any key on the remote control.

- The display stops flashing and momentarily shows PROGRAM to confirm recognition of a new house code.
- The display verifies the house code by lighting four rectangles corresponding to the four switch positions (up or down). See the example in Figure 31.

8. Release the STORE key. The system remains off.
9. If you have additional remote controls, change the switches to match those of the first remote control. It is not necessary to repeat steps 4-8.

♪ **Note:** To verify your system's house code, press STORE while the system is off. The display confirms the settings of switches 1-4.

**Figure 31**

Display confirming an example of house code setting: switch 1 up, switches 2, 3, and 4 down

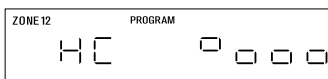

## Taking care of your Lifestyle® 30 system

The only maintenance needed is cleaning the system and your compact discs, and replacing remote control batteries.

For information on replacing the remote control batteries see “Install the batteries in the remote control” on page 17.

**Figure 32**

Handling a CD

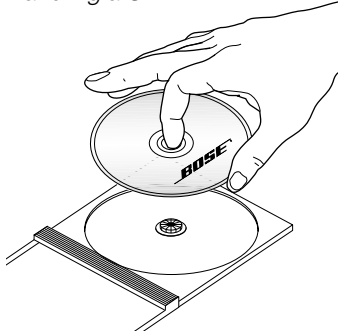

### Handling CDs

Handle discs by their edges to prevent fingerprints and scratches (Figure 32).

To remove stains or fingerprints from the surface of a disc, use a soft, lint-free, dry cloth. Wipe in straight movements from the center of the disc to the outside (Figure 33). Do not use any chemical products; they can damage the disc.

Do not write on or attach labels to the surface of the disc.

To minimize exposure to dust and dirt, replace discs in their cases after use. Store each disc in its case, out of direct sunlight, high temperatures, and humidity.

### Cleaning the music center

Use only a soft, dry cloth to clean the outside of the music center.

Do not use any solvents, chemicals, or cleaning solutions containing alcohol, ammonia, or abrasives. Do not allow liquids to spill into any openings. Do not use any sprays near the system.

**Figure 33**

Cleaning a CD

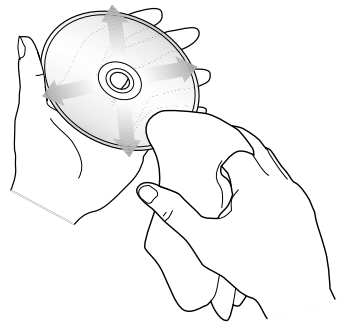

### Cleaning the speakers

Clean the surface of your speakers with a soft, damp cloth. You can use an ammonia-free window cleaner on a soft cloth to maintain the finish.

Do not use any sprays near the system. Do not use any solvents, chemicals, or cleaning solutions containing alcohol, ammonia, or abrasives. Do not allow liquids to spill into any openings.

The speaker grille panels require no special care, although you may vacuum them carefully, if necessary.









### Transporting your music center

To transport your music center, follow these steps to lock down the CD mechanism.

1. Eject the CD magazine.
2. Make sure the music center is off (all zones).
3. On the music center, press STORE, ERASE, and PLAY/PAUSE at the same time. Then release.
4. Press and hold the EJECT button for 10 seconds. The CD elevator moves into locked down position.
5. If you hear the elevator continue to move up and down, wait 10 seconds and then repeat steps 3 and 4.

The CD mechanism unlocks automatically the next time you select CD.

## Troubleshooting

<b>Problem</b>	<b>What to do</b>
System does not function at all	<ul style="list-style-type: none"> <li>• Make sure the power connector is inserted securely into the music center, the power cord is inserted securely into the Acoustimass® module, and the power pack and power cord are plugged fully into operating AC wall outlets.</li> <li>• Be sure to select a source (CD, AM/FM, etc.).</li> <li>• Unplug the music center power pack for a minute, then reconnect it. This allows the unit to reset itself after a power surge or power interruption.</li> <li>• If the system is not responding, press STORE, ERASE, and ON/OFF (on the music center) at the same time, to reset the system.</li> </ul>
No sound	<ul style="list-style-type: none"> <li>• Increase the volume.</li> <li>• Check to see if MUTE is lit on the display. If it is, press the MUTE button on the remote control to unmute the sound.</li> <li>• Make sure the audio input cable is firmly seated in the music center SPEAKER ZONE 1 jack and the multi-pin connector on the other end is firmly seated in the Acoustimass module AUDIO INPUT jack.</li> <li>• Check speaker connections.</li> <li>• Make sure the digital audio input cable is firmly seated in the music center AUX jack and the other end of the cable is firmly seated in the connector at the digital source.</li> <li>• Turn the music center off for 10 seconds, then on again, to restore communication between the music center and the speakers.</li> <li>• Check the connections for any external components. Make sure to select the correct source for the desired input.</li> <li>• Be sure the CD is placed correctly, label-side up, in the magazine, and the magazine is inserted properly in the music center.</li> <li>• Disconnect any headphones.</li> <li>• Connect the FM and AM antennas.</li> </ul>
No sound from center speaker	<ul style="list-style-type: none"> <li>• Make sure the center cube cable is connected at both ends.</li> <li>• Select STEREO+CENTER  (3-speaker) or SURROUND  (5-speaker) mode.</li> </ul>
Too much sound from center speaker	<ul style="list-style-type: none"> <li>• In STEREO+CENTER (3-speaker) mode, press SURROUND  to decrease center speaker volume.</li> <li>• Press and hold the STEREO+CENTER  (3-speaker) button for 10 seconds to restore the factory preset center volume setting.</li> </ul>
No sound from surround speakers	<ul style="list-style-type: none"> <li>• Select SURROUND  (5-speaker) mode.</li> <li>• Press SURROUND .</li> <li>• Press and hold the SURROUND  (5-speaker) button for 10 seconds to restore the factory preset surround volume setting.</li> <li>• Make sure the video sound source is stereo and surround-encoded, and the component used (TV, VCR, DVD, or laserdisc player) is stereo.</li> </ul>
Surround speakers are too loud	<ul style="list-style-type: none"> <li>• In SURROUND (5-speaker) mode, press SURROUND .</li> <li>• Make sure that the left and right front speakers are connected to the front speaker jacks (blue) and the left and right surround speakers are connected to the surround speaker jacks (orange).</li> <li>• Press and hold the SURROUND  (5-speaker) button for 10 seconds to restore the factory preset surround volume setting.</li> </ul>

<b>Problem</b>	<b>What to do</b>
Remote control is inconsistent or does not work	<ul style="list-style-type: none"> <li>• Check batteries and their polarity (+ and -). See page 17.</li> <li>• Operate the remote control closer to the music center.</li> <li>• Move the remote (or the music center) a few feet to avoid an area of “dead spots.” See note on page 19.</li> <li>• Make sure the audio input cable is firmly seated, uncoiled, and extended as much as possible.</li> <li>• Make sure the remote control and music center house codes match. Follow steps 4-8 on page 32 to match the house code settings.</li> </ul>
Unit turns on and off by itself, or behaves erratically	<ul style="list-style-type: none"> <li>• Change the house code setting to prevent signals from conflicting with another nearby Lifestyle® system. See page 32 for instructions on setting the house code.</li> </ul>
Radio does not work	<ul style="list-style-type: none"> <li>• Make sure antennas are connected properly.</li> <li>• Move AM antenna at least 20 inches (50 cm) from the music center.</li> <li>• Adjust antenna position to improve reception.</li> <li>• AM antenna must be upright.</li> <li>• Move antennas farther from TV or other electronic equipment.</li> <li>• You may be in an area of weak signal coverage.</li> </ul>
CD does not play	<ul style="list-style-type: none"> <li>• Check to see if the play symbol ► in the display is lit.</li> <li>• After pressing the CD key, wait a few seconds before pressing PLAY.</li> <li>• Make sure the magazine is properly inserted.</li> <li>• Check to see if there is a disc in the magazine, label-side up. Display shows a flashing box for a disc that is label-side down or cannot be read.</li> <li>• Eject the magazine and try loading the CD again.</li> <li>• There may be dirt or dust on the CD. Clean the CD. See Figure 33 on page 33.</li> <li>• The disc may be defective. Try another disc.</li> <li>• A display message “E01” indicates a mechanical error. Unplug the music center. Reconnect power and try again. If “E01” reappears, call Bose® customer service (see inside back cover for listings).</li> </ul>
FM sound is distorted	<ul style="list-style-type: none"> <li>• Adjust antenna position to reduce interference.</li> </ul>
FM sound is noisy in surround mode	<ul style="list-style-type: none"> <li>• Weak FM stations will produce static in the surround speakers. Press the STEREO  (2-speaker) button to minimize noise.</li> </ul>
Sound is distorted	<ul style="list-style-type: none"> <li>• Make sure speaker cables are not damaged and the connections are secure.</li> <li>• Reduce the output level from any external components connected to the music center.</li> </ul>
No tape, CD, VCR, or TV sound	<ul style="list-style-type: none"> <li>• Check the connections.</li> <li>• Make sure the component is turned on.</li> <li>• Refer to the component owner’s manual.</li> </ul>

### **Warranty period**

The Bose Lifestyle® 30 system is covered by a limited 1-year transferable warranty. Details of the warranty are provided on the warranty card that came with your system. Please fill out the information section on the card and mail it to Bose.

### **Customer service**

For additional help in solving problems, contact Bose customer service. See the inside back cover for Bose Corporation customer service offices and phone numbers.

## Technical information

### Music center power pack power rating

USA/Canada: 120V~ 60 Hz 25VA

Europe: 230V~ 50 Hz 25VA

Australia: 240V~ 50 Hz 25VA

Dual voltage: 120V~ 60 Hz 25VA and  
230V~ 50 Hz 25VA

### Speaker system power rating

USA/Canada: 120V~ 50/60 Hz 350W

Europe/Australia: 220-240V~ 50/60 Hz 350W

Dual voltage: 115/230V~ 50/60 Hz 350W

### Music center inputs

TAPE: 2Vrms, maximum

AUX, VIDEO: 2Vrms, maximum

FM antenna: 75Ω

AM antenna: 12μH

Power: 12V~, 1.3A

### Music center outputs

Variable audio: SPEAKER ZONES 1 and 2

Fixed audio: ZONE 1, ZONE 2, TAPE

Headphone: 32Ω minimum impedance

SERIAL DATA: for future use

Zone connector pinout:

1: variable left audio

2: variable right audio

3: fixed left audio

4: fixed right audio

5: audio ground

6: +10V control line

7: SMART SPEAKER data

8: control line ground (and remote antenna)

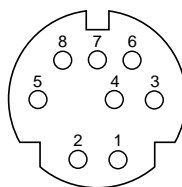

### Remote control range

65 feet (20 m)

### Dimensions

Music center

15.5" W x 8.0" D x 2.6" H  
(39.4 cm x 20.3 cm x 6.6 cm)

Jewel Cube® speaker

2.2" W x 3.2" D x 4.4" H  
(5.6 cm x 8.1 cm x 11.2 cm)

Acoustimass® module

23.3" W x 7.5" D x 14.0" H  
(59.0 cm x 19.0 cm x 35.5 cm)

### Weights

Music center

5.9 lb (2.7 kg)

Jewel Cube speaker

1.0 lb (0.5 kg)

Acoustimass module

33 lb (15.0 kg)

Total shipping weight

60 lb (27.3 kg)

### Finish

Music center

Aluminum

Jewel Cube speakers

Polymer, painted

Acoustimass module

Vinyl veneer, Polymer

## Accessories

To find out about mounting brackets, stands, CD magazines, additional remote controls, and connecting additional Bose® powered loudspeakers, contact your Bose dealer. Or call Bose directly (see inside back cover for phone numbers).

- A**  
AA 5, 17  
AC POWER 11  
AC power cord 5, 11  
AC power pack 5, 10, 11  
accessories 36  
acoustic image 6  
Acoustimass® module 2-11, 16, 18, 29, 34, 36  
AM antenna 5, 16, 34, 35, 36  
AM/FM 4, 20, 22-24, 27, 28, 34  
analog 4, 12, 13, 15, 22, 24  
ANTENNA 16  
antenna 5, 16, 34, 35, 36  
audio cable 12, 13  
AUDIO INPUT 10, 34  
audio input cable 5, 8, 10, 34  
audio tapes 8  
Australia 5, 11, 36  
AUX 12, 13, 20, 22, 28, 30, 36
- B**  
barrel connector 9  
BASS 29  
batteries 2, 5, 17, 33, 35
- C**  
cable 5-12, 14, 34, 35  
cable box 4, 22  
cable radio 16  
cable TV 12, 16  
Canada 5, 11, 36  
CD 8, 12, 19, 20, 23-28, 30, 33-36  
CD changer 4, 20, 24, 26  
CD magazine 5, 20, 24, 25, 33  
center speaker 6, 10, 23, 34  
channel spacing 17, 19  
chimes 21-23  
cleaning 33  
coaxial 12-14  
components 11-15, 28, 34, 35  
connections 9-11, 15, 16, 34, 35  
controls 2, 8, 13, 14, 19-21, 29, 36  
customer service 6, 9, 35
- D**  
damage 5, 24, 35  
dead spots 19, 35  
decoder 4, 12  
digital  
    audio input 24  
    audio source 4, 24  
    bitstreams 22, 24  
    signal processing 22  
    sound 4, 24  
display 12, 15, 18, 24-28, 31, 32, 34, 35  
distorted 35  
Dolby Digital 4, 12, 22, 24  
Dolby Surround 4, 24  
DTS 4, 24  
DTV 12, 24  
dual voltage 5, 11, 17, 36  
DVD 4, 8, 12-14, 24, 28  
Digital Dynamic Range®  
    compression 4, 21-23
- E**  
E01 35  
EJECT 33  
eject 25  
encoded 12, 24  
enhanced mode 22, 23, 28  
ERASE 27, 33, 34  
error 35  
EU 17  
Europe 5, 11, 17, 36  
expanded stereo 13, 14  
external antenna 16
- F**  
5.1 4, 22  
5-speaker 21-24, 26, 28, 34  
factory preset 11, 17  
female-to-female adapter 9  
finish 36  
five-channel 4, 22  
fixed 12-14  
FM 75Ω EXTERNAL antenna 16  
FM ANTENNA 16  
FM antenna 5, 16, 36  
front speaker 5, 6, 8, 10, 34
- H**  
handling CDs 33  
headphones 28, 34  
home theater 6, 13, 12  
house code 17, 18, 19, 30, 32, 35
- I**  
IEC-R6 17  
input 12-15, 36  
interference 8, 35  
internal/external 13, 14  
international use 11
- J**  
Jewel Cube® speakers 4-6, 9, 36
- L**  
laserdisc 12-14, 34  
Lifestyle® system CD 5  
line level outputs 12
- M**  
magazine 24, 25, 34, 35  
magnetic 6, 8  
male phono plugs 9  
manual tuning 27  
mega-bass 13, 14  
moisture 2  
mono 4, 12, 15, 23  
mounting brackets 36  
movie soundtracks 22, 28  
MPEG-2 4, 24  
multi-pin connector 10, 34  
music center 2-5, 8-12, 15, 16, 18-21, 25-28, 30-36  
music center door 18  
MUTE 20, 34  
mute 18  
MUTE ALL 20
- N**  
NEXT DISC 20, 26  
NONE 26  
North America 11, 17
- O**  
1 chime 21-23  
115/230V 36  
115V 11  
120V 11, 17, 36  
ON/OFF 31, 34  
one chime 21-23  
one-channel 22  
open music center 18  
orange 5, 9, 34  
outdoor antenna 16  
outlet 8, 9, 11, 18, 34
- P**  
PAUSE 26  
Pause 18  
PCM 4, 12, 22, 24  
phantom 13, 14  
phone numbers 35, 36  
placement 6, 7, 16, 29  
PLAY 20, 26, 35  
Play 18  
PLAY/PAUSE 33  
polarity 35  
port 6, 8  
power cord 5, 11, 18, 34  
power pack 5, 11, 18, 34, 36  
power rating 36  
powered speaker 29, 30, 34  
preset 19, 20, 27  
problems 35  
PROGRAM 32  
purchase date 3

**R**

radio 19, 20, 26, 27, 30, 31, 35  
radio station presets 19  
RANDOM 20, 26  
random 18, 26  
RCA cables 9, 13-15  
RCA connector 10, 12  
RCA connectors 9  
RCA extension cables 9  
red 12, 15  
remote control 5, 17, 19-21 28, 30-32,  
34-36  
room acoustics 29  
rubber feet 5, 6, 8

**S**

safety 2  
SAP 13, 14  
satellite 4, 12  
seek 27  
SERIAL DATA 36  
serial number 3, 5  
signal processing technology 29  
signal splitter 16  
simulated surround 23  
SKIP 20, 26, 27  
slot 8, 24  
sound level 4  
sound source 4, 8, 12-14, 18, 28, 30  
SOURCE SELECT 20, 26, 28  
source select 31  
speaker cable 5, 6, 8, 9, 35  
speaker connections 10  
speaker mode 19, 27  
speaker placement 6, 7, 29  
SPEAKER ZONE 10, 28, 30, 34, 36  
special effect 4, 22  
special features 23  
spill 33  
splice 9  
sprays 33  
stability 6, 8  
standard mode 28  
station frequency 18  
STEREO 21, 23, 26, 28, 35  
stereo 4, 12-14  
stereo cable 5, 12  
STEREO+CENTER 21, 23, 26, 28, 34  
STOP 20, 26, 27  
Stop 18  
STORE 27, 32, 33, 34  
SURROUND 21, 23, 24, 26, 28, 34  
surround 4, 5, 7, 9, 10, 12, 24, 34  
surround speaker 5, 10 23, 24,  
surround-encoded 24  
switches 17, 27, 30, 32

**T**

3 chimes 21-23  
3-speaker 21, 26, 28, 34  
2 chimes 21-23  
2-speaker 21, 22, 26, 28  
220V 36  
230V 11, 17, 36  
240V 11, 36  
TAPE 15, 20-23 28, 30, 36  
tape deck 15, 20, 28  
TAPE jacks 28  
tapes 8  
Test CD 5, 18  
three chimes 21-23  
tone settings 29  
TREBLE 29  
Troubleshooting 34  
TUNE 19, 26, 27  
tuner 20, 30  
TUNING 27  
tuning 6, 27, 29  
turntable 15  
TV 4, 6, 8, 12-16, 34, 35  
two chimes 21-23  
two-channel 22

**U**

UK/Singapore 5  
unpack 5  
US 17  
USA/Canada 5, 17, 36

**V**

variable 12, 14  
VCR 8, 12, 14, 34, 35  
ventilation 8  
vibration 6  
VIDEO 15, 20, 23, 28, 30, 36  
VIDEO 1 13, 14, 15, 23  
VIDEO 2 13, 15, 22  
video cable 12  
video input 14  
video signal 15  
VIDEO SOUND 36  
video sound 12, 20, 28  
video tapes 8  
Videostage® 4, 12, 22  
voltage 2, 5, 11, 36  
VOLUME 20, 28  
volume 4, 13, 14, 19, 20, 28,  
29, 31, 34

**W**

warranty 3, 5, 33, 35  
weak 35  
weak station 27  
weight 36

**Z**

ZONE 30, 36  
zone 4, 18, 20, 28, 30, 31, 32





## **USA**

Bose Corporation, The Mountain  
Framingham, MA 01701-9168  
1-800-367-4008  
Phone hours - ET (eastern time):  
Weekdays 8:30 a.m. to 8 p.m.  
Saturdays 9 a.m. to 3 p.m.

## **Canada**

Bose Ltd., 1-35 East Beaver Creek Road  
Richmond Hill, Ontario L4B 1B3  
1-800-465-2673  
Phone hours - ET (eastern time):  
Weekdays 9 a.m. to 5 p.m.

## **European Office**

Bose Products B.V., Nijverheidstraat 8  
1135 GE Edam, Nederland  
TEL 0299-390111 FAX 0299-390114

## **Australia**

Bose Pty Limited, 1 Sorrell Street  
Parramatta NSW, 2150  
TEL 02 9204-6111 FAX 02 9204-6122

## **Belgique/België**

Bose N.V., Limesweg 2, B-3700 Tongeren  
TEL 012-390800 FAX 012-390840

## **Danmark**

Bose A/S, Industrivej 7, 2605 Brøndby  
TEL 4343-7777 FAX 4343-7818

## **Deutschland**

Bose GmbH, Max-Planck-Straße 36d  
D-61381 Friedrichsdorf  
TEL 06172-71040 FAX 06172-710419

## **France**

Bose S.A., 6, rue Saint Vincent  
78100 Saint Germain en Laye  
TEL 01-30616363 FAX 01-30614105

## **India**

Bose Corporation India Private Limited  
W-16, Greater Kailash-II  
New Delhi 110 048  
TEL (011) 648 4462 FAX (011) 648 4463

## **Ireland**

Bose Corporation  
Carrickmacross, Co Monaghan  
TEL (042) 9661988 FAX (042) 9661998

## **Italia**

Bose S.p.A., Via della Magliana 876  
00148 Roma  
www.bose.it  
TEL 06-65670802 FAX 06-65680167

## **Japan**

Bose K.K., Shibuya YT Building  
28-3 Maruyama-cho  
Shibuya-ku, Tokyo 150  
TEL 3-5489-0955 FAX 3-5489-0592

## **Nederland**

Bose B.V., Nijverheidstraat 8  
1135 GE Edam  
TEL 0299-390111 FAX 0299-390109

## **Norge**

Bose A/S, Solheimsgate 11  
N-2001, Lillestrøm  
TEL 63-817380 FAX 63-810819

## **Österreich**

Bose Ges.m.b.H., Vienna Business Park  
Wienerbergstrasse 7 (10.OG)  
A-1100 Vienna  
TEL 01-60404340 FAX 01-604043423

## **Schweiz**

Bose AG, Rünenbergerstrasse 13  
4460-Gelterkinden  
TEL 061-9815544 FAX 061-9815502

## **Sverige**

Bose A/S, Johannefredsgatan 4  
S-43153 Mölndal  
TEL 31-878850 FAX 31-274891

## **United Kingdom**

Bose Limited  
1 Ambley Green  
Gillingham Business Park  
Gillingham, Kent ME8 ONJ  
TEL 0870-741-4500 FAX 0870-741-4545

## **From other locations**

Bose Customer Service, 1 New York Ave.  
Framingham, MA 01701-9168 USA  
TEL (508) 766-1900 FAX (508) 766-1919

## **World Wide Web**

www.bose.com

***BOSE***<sup>®</sup>  
***Better sound through research***<sup>®</sup>

©2001 Bose Corporation  
The Mountain, Framingham, MA 01701-9168 USA  
199736 AM Rev.06 JN20413