

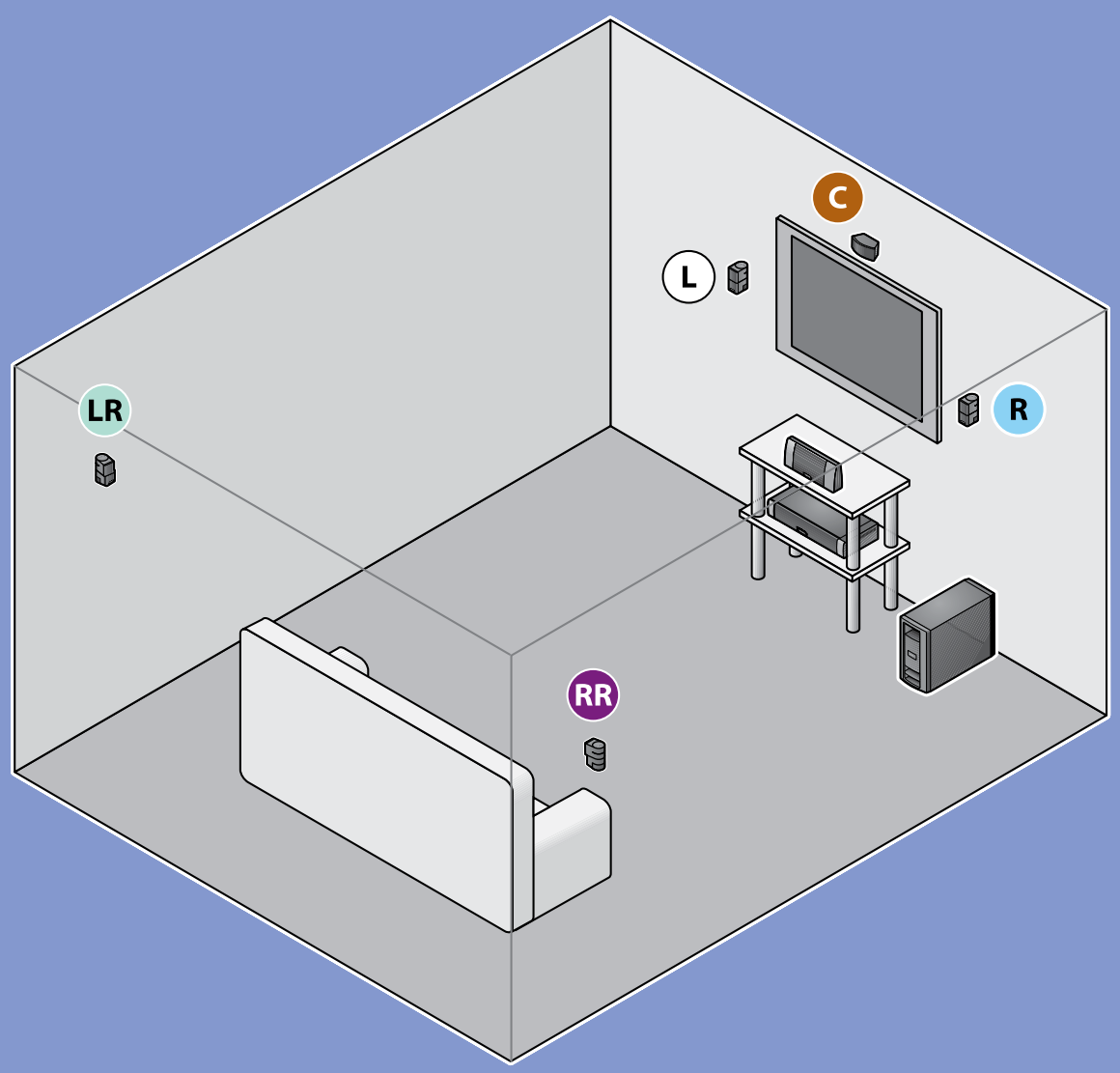

BOSE
©2008 Bose Corporation, The Mountain,
Framingham, MA 01701-9168 USA
AM316798 Rev.00



1



2

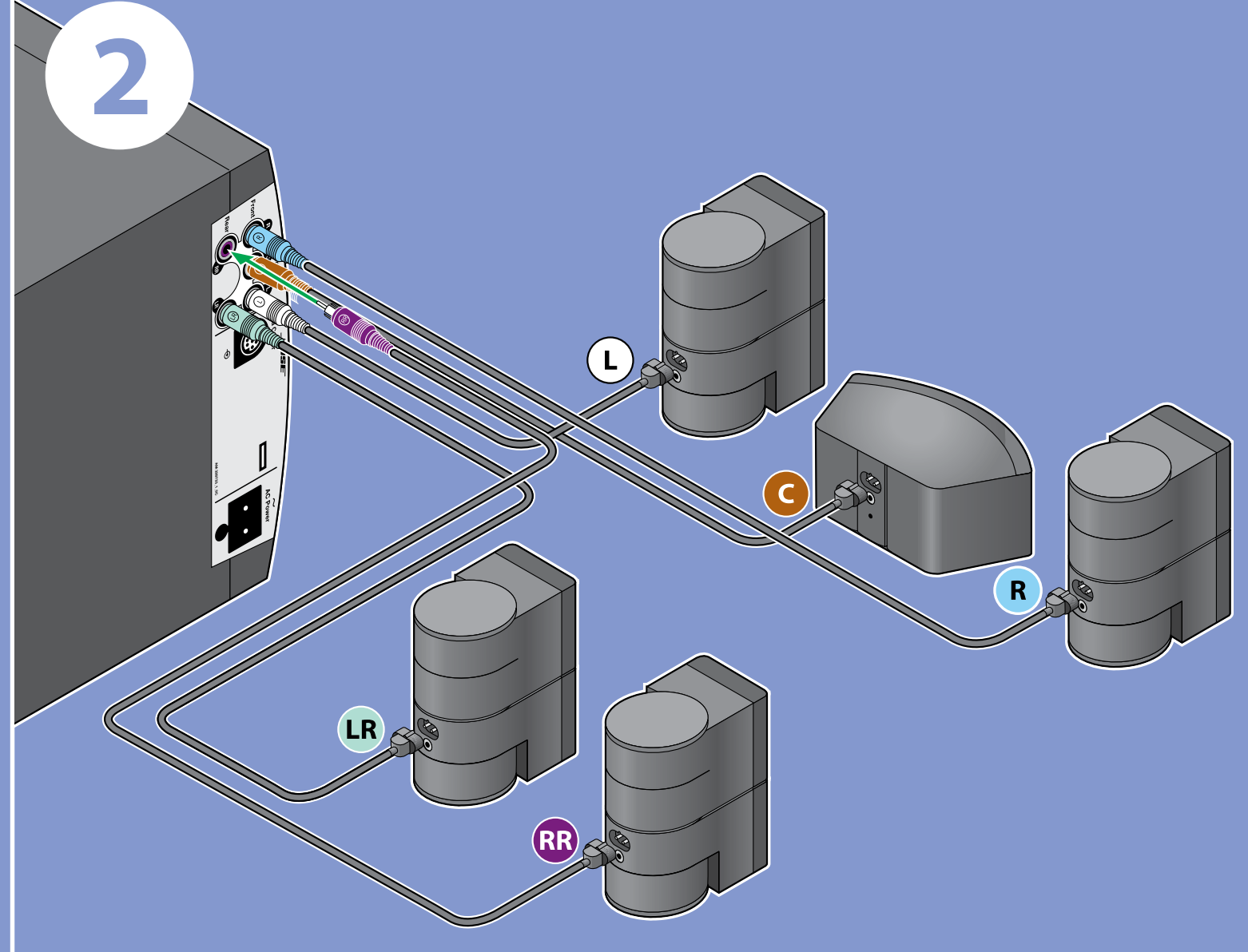

3

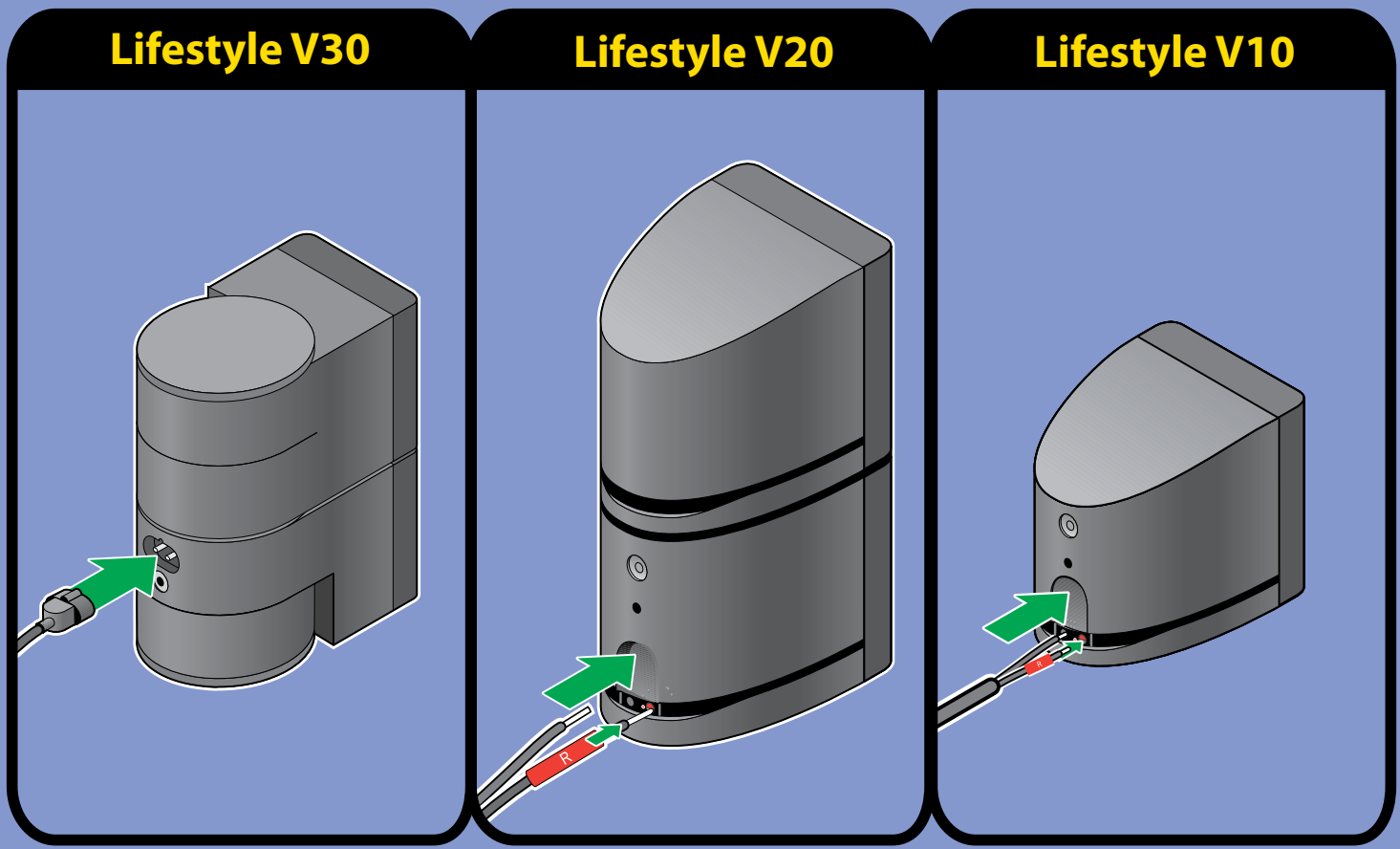

4

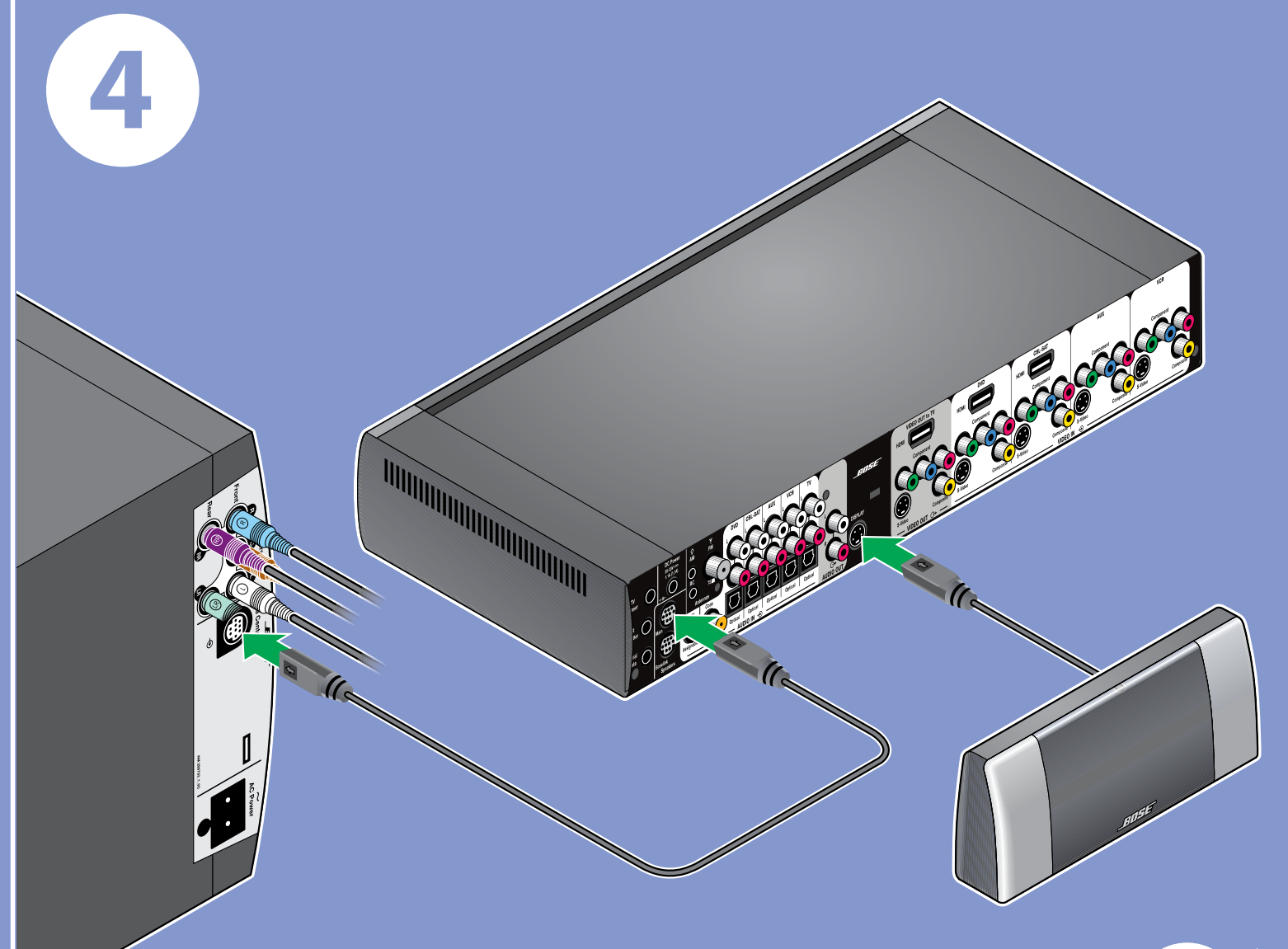

5

5

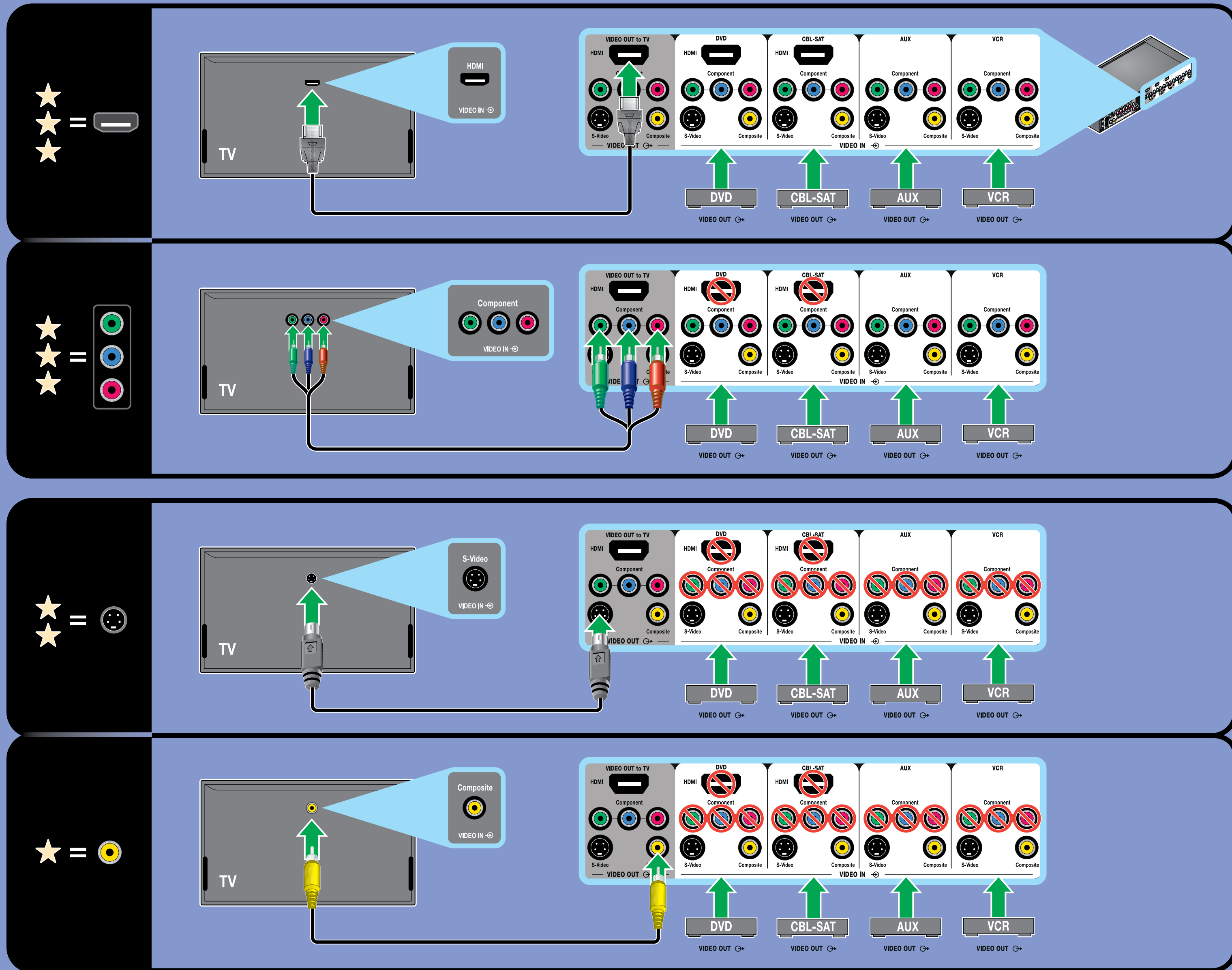

6

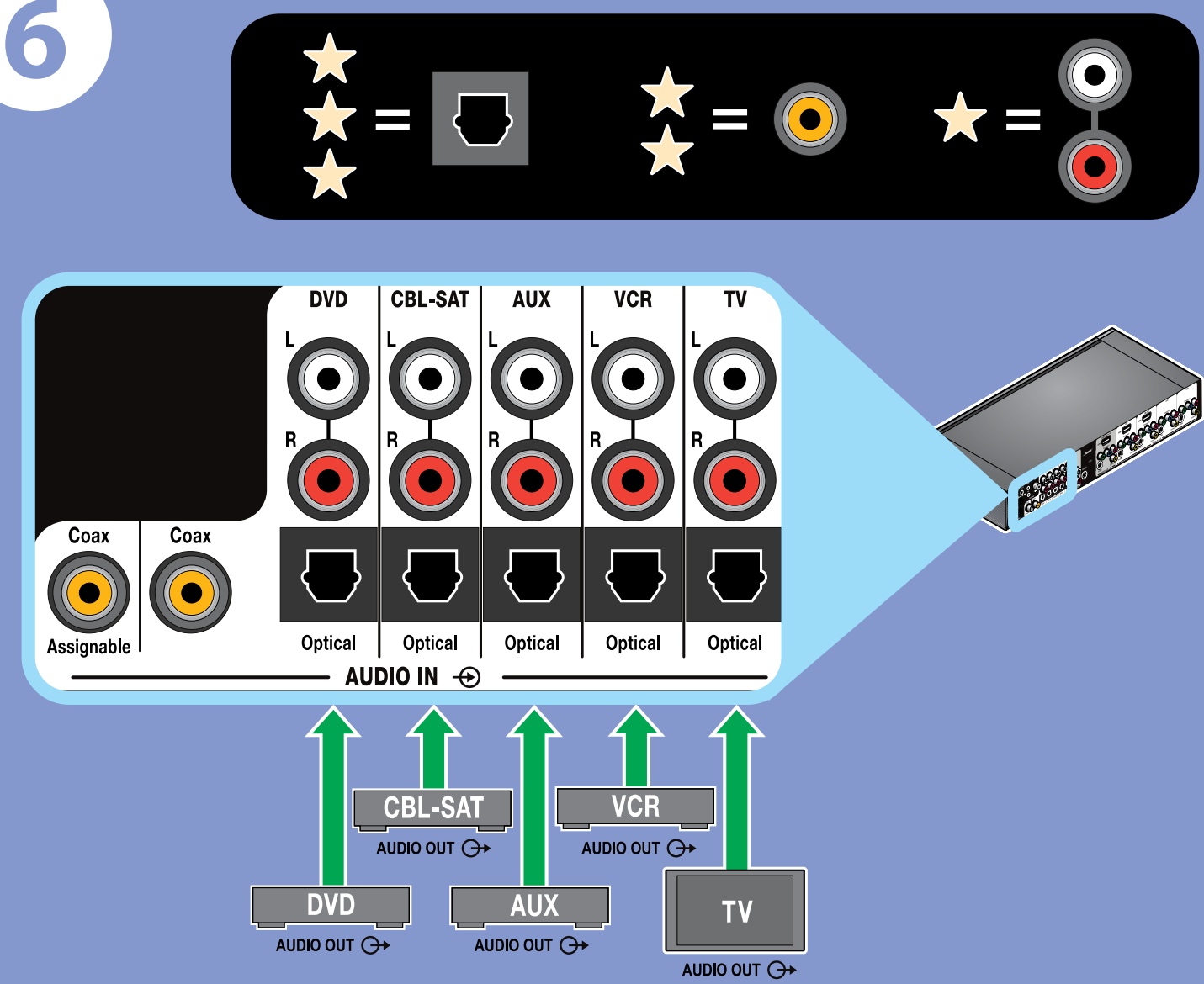

7

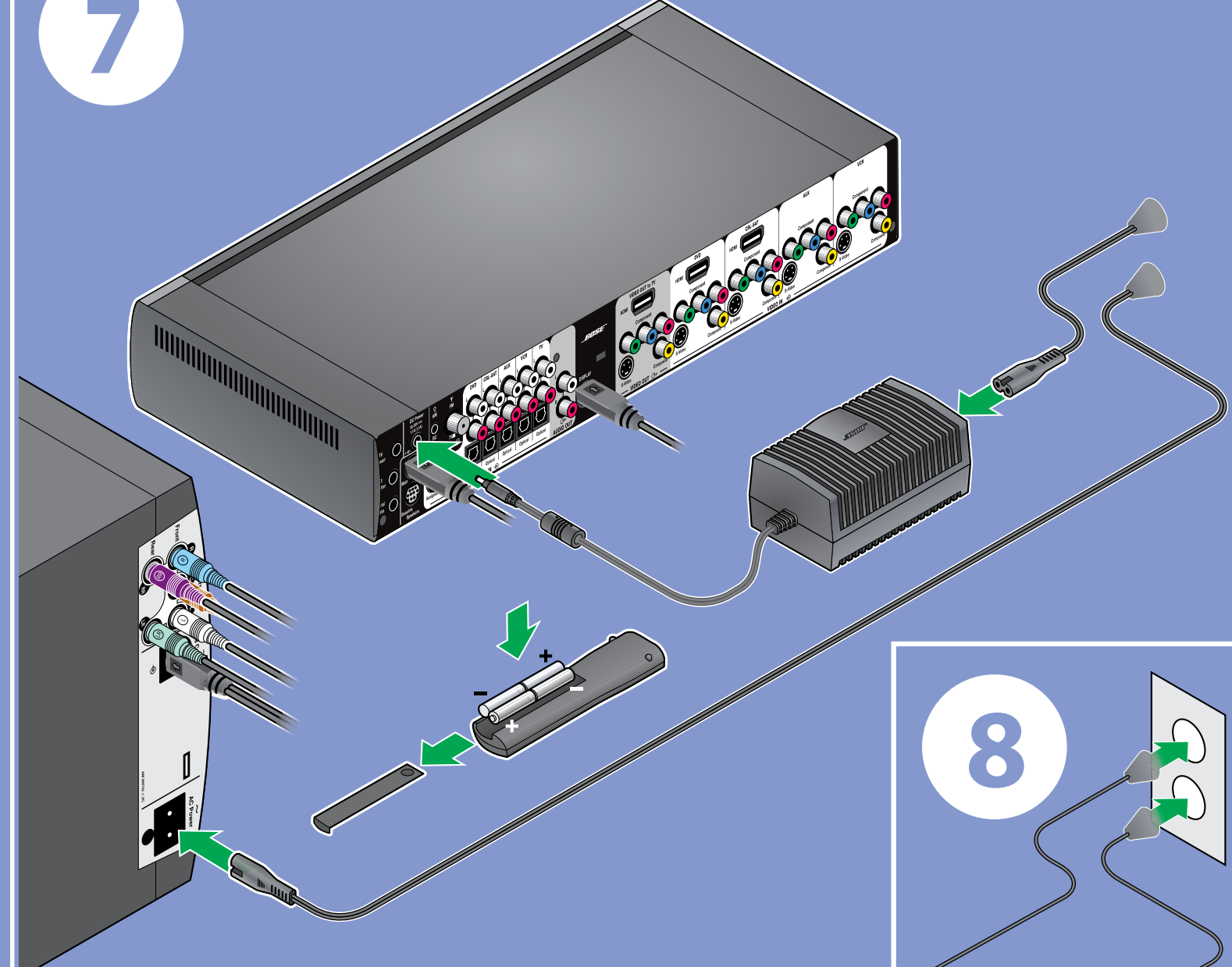

8

