

BOSE[®]



SoundTouch™ Stereo JC

Wi-Fi® music system

Owner's Guide | តួអង្គដ្ឋៃ | 사용자 안내서 | 用户指南 | 使用者指南 | دليل المالك

Safety Information

Please take the time to follow the instructions in this owner's guide carefully. It will help you set up and operate your system properly and enjoy its advanced features. Please save this guide for future reference.

All Bose products must be used in accordance with local, state, federal, and industry regulations.

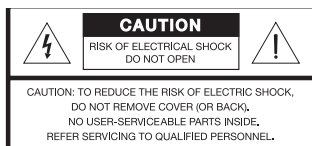

The lightning flash with arrowhead symbol within an equilateral triangle alerts the user to the presence of uninsulated, dangerous voltage within the system enclosure that may be of sufficient magnitude to constitute a risk of electric shock.



The exclamation point within an equilateral triangle, as marked on the system, is intended to alert the user to the presence of important operating and maintenance instructions in this owner's guide.



WARNINGS:

- To reduce the risk of fire or electrical shock, do not expose the product to rain or moisture.
- Do not expose this apparatus to dripping or splashing, and do not place objects filled with liquids, such as vases, on or near the apparatus. As with any electronic products, use care not to spill liquids into any part of the system. Liquids can cause a failure and/or a fire hazard.
- To prevent electric shock, match the wide blade of the line cord plug to the wide slot of the AC (mains) receptacle. Insert the plug fully into the receptacle.
- Keep battery (or batteries) away from children. May cause a fire or chemical burn if mishandled. Do not recharge, disassemble, heat above 212°F (100°C), or incinerate. Dispose of used batteries promptly. Replace only with a battery of the correct type and model number.
- Danger of explosion if battery (or batteries) is incorrectly replaced. Use only AA batteries (IEC LR06).
- Do not place any naked flame sources, such as lighted candles, on or near the apparatus.



WARNING: Contains small parts which may be a choking hazard. Not suitable for children under age 3.



WARNING: This product contains magnetic material. Please contact your physician if you have any questions on whether this might affect the operation of your implantable medical device.



Please dispose of used batteries properly, following any local regulations. Do not incinerate.



CAUTIONS:

- To prevent electric shock, match the wide blade of the line cord plug to the wide slot of the AC (mains) receptacle. Insert the plug fully into the receptacle.
- Long-term exposure to loud music may cause hearing damage. It is best to avoid extreme volume when using headphones, especially for extended periods.
- The product must be used indoors. It is neither designed nor tested for use outdoors, in recreation vehicles, or on boats.
- Make no modifications to the system or accessories. Unauthorized alterations may compromise safety, regulatory compliance, and system performance.

NOTES:

- The product label is located on the bottom of the system.
- Where the mains plug or appliance coupler is used as the disconnect device, such disconnect device shall remain readily operable.
- The speaker wire and interconnect cables included with the system are not approved for in-wall installation. Please check your local building codes for the correct type of wire and cable required for in-wall installation.
- Changes or modifications not expressly approved by Bose Corporation could void the user's authority to operate this equipment.
- Operate this product within the temperature range of 32° F to 104° F (0° C to 40° C).

Important Safety Instructions

1. Read these instructions.
2. Keep these instructions.
3. Heed all warnings.
4. Follow all instructions.
5. Do not use this apparatus near water.
6. Clean only with a dry cloth.
7. Do not block any ventilation openings. Install in accordance with the manufacturer's instructions.
8. Do not install near any heat sources such as radiators, heat registers, stoves, or other apparatus (including amplifiers) that produce heat.
9. Do not defeat the safety purpose of the polarized or grounding-type plug. A polarized plug has two blade with one wider than the other. A grounding type plug has two blades and a third grounding prong. The wide blade or the third prong are provided for your safety. If the provided plug does not fit into your outlet, consult an electrician for replacement of the obsolete outlet.
10. Protect the power cord from being walked on or pinched particularly at plugs, convenience receptacles, and the point where they exit from the apparatus.
11. Only use attachments/accessories specified by the manufacturer.
12. Unplug this apparatus during lightning storms or when unused for long periods of time.
13. Refer all servicing to qualified personnel. Servicing is required when the apparatus has been damaged in a way, such as power-supply cord or plug is damaged, liquid has been spilled or objects have fallen into the apparatus, the apparatus has been exposed to rain or moisture, does not operate normally, or has been dropped.

Important USA and Canada compliance Information

- This device complies with part 15 of the FCC rules and Industry Canada license-exempt RSS standard(s). Operation is subject to the following two conditions: (1) This device may not cause harmful interference, and (2) this device must accept any interference received, including interference that may cause undesired operation.
- This device complies with FCC and Industry Canada RF radiation exposure limits set forth for general population.
- This device must not be co-located or be operating in conjunction with any other antennas or transmitters.
- This device complies with Industry Canada license-exempt RSS standard(s). Operation is subject to the following two conditions: (1) This device may not cause interference, and (2) this device must accept any interference, including interference that may cause undesired operation.
- **For SoundTouch Wireless Adapter:** This equipment should be installed and operated with a minimum distance of 8 in. (20 cm) between this device and your body.

CAN ICES-3 (B)/NMB-3(B)

This Class B digital apparatus complies with Canadian ICES-003.

Information about products that generate electrical noise

This equipment has been tested and found to comply with the limits for a Class B digital device, pursuant to Part 15 of the FCC Rules. These limits are designed to provide reasonable protection against harmful interference in a residential installation. This equipment generates, uses, and can radiate radio frequency energy and, if not installed and used in accordance with the instructions, may cause harmful interference to radio communications. However, there is no guarantee that interference will not occur in a particular installation. If this equipment does cause harmful interference to radio or television reception, which can be determined by turning the equipment off and on, the user is encouraged to try to correct the interference by one or more of the following measures:

- Reorient or relocate the receiving antenna.
- Increase the separation between the equipment and receiver.
- Connect the equipment into an outlet on a circuit different from that to which the receiver is connected.
- Consult the dealer or an experienced radio/TV technician for help.

 Bose Corporation hereby declares that this product is in compliance with the essential requirements and other relevant provisions of Directive 1999/5/EC and all other applicable EU directive requirements. The complete Declaration of Conformity can be found at www.Bose.com/compliance.

Safety Information

Names and Contents of Toxic or Hazardous Substances or Elements						
Part Name	Toxic or Hazardous Substances and Elements					
	Lead (Pb)	Mercury (Hg)	Cadmium (Cd)	Hexavalent (CR(VI))	Polybrominated Biphenyl (PBB)	Polybrominated diphenylether (PBDE)
PCBs	X	0	0	0	0	0
Metal parts	X	0	0	0	0	0
Plastic parts	0	0	0	0	0	0
Speakers	X	0	0	0	0	0
Cables	X	0	0	0	0	0

O: Indicates that this toxic or hazardous substance contained in all of the homogeneous materials for this part is below the limit requirement in SJ/T 11363-2006.

X: Indicates that this toxic or hazardous substance contained in at least one of the homogeneous materials used for this part is above the limit requirement in SJ/T 11363-2006.

Please complete and retain for your records.

The serial and model numbers can be found on the product label of the system.

Acoustimass® serial and model numbers: _____

Wireless adapter serial and model numbers: _____

SoundTouch™ controller serial and model numbers: _____

Purchase date: _____

We suggest you keep your receipt with this owner's guide.



Made for

iPod iPhone iPad

AirPlay works with iPhone, iPad, and iPod touch with iOS 4.3.3 or later, Mac with OS X Mountain Lion, and Mac and PC with iTunes 10.2.2 or later.

AirPlay, Apple, iPad, iPhone, iPod touch, iTunes, Mac, and OS X are trademarks of Apple Inc., registered in the U.S. and other countries.

App Store is a service mark of Apple Inc.

"Made for iPod," "Made for iPhone," and "Made for iPad" mean that an electronic accessory has been designed to connect specifically to iPod, iPhone, or iPad, respectively, and has been certified by the developer to meet Apple performance standards. Apple is not responsible for the operation of this device or its compliance with safety and regulatory standards. Please note that the use of this accessory with iPod, iPhone, or iPad may affect wireless performance.

The *Bluetooth*® word mark and logos are registered trademarks of Bluetooth SIG, Inc. and any use of such marks by Bose is under license.

Android and Google Play are trademarks of Google Inc.

SoundTouch and the wireless note design are trademarks of Bose Corporation in the U.S. and other countries.

Wi-Fi is a registered mark of the Wi-Fi Alliance.

Windows is a registered trademark of Microsoft Corporation in the United States and other countries.

A personal computer is required for system setup. A home Wi-Fi network and Internet access are required.

© 2013 Bose Corporation. No part of this work may be reproduced, modified, distributed, or otherwise used without prior written permission.

Introducing SoundTouch™ from Bose®

Key Benefits	7
--------------------	---

Introduction

About your SoundTouch™ music system	8
System features	8

Setting up the System

Unpacking the system.....	9
Adding the system to your Wi-Fi® network.....	10
Installing the SoundTouch™ app.....	10
Connecting the system to your home Wi-Fi® network	11
Placing the speakers.....	13
Connect the speakers	15
Placing the SoundTouch™ wireless adapter	16

Controlling the System using the App

Using the SoundTouch™ app	17
Getting help.....	17
Downloading the app for your mobile device.....	18
Controlling the system from another computer	18

Using the System

Playing music with the SoundTouch™ controller	19
Using the SoundTouch™ controller.....	19
Playing an AirPlay stream from an AirPlay compatible device.....	20
Getting system information.....	20
SoundTouch™ wireless adapter Wi-Fi indicator	20

Personalizing your Presets

How presets work	21
What you need to know.....	21
Playing a preset	21
Setting a preset	21
To set a preset.....	21
To change a preset.....	21

Contents

ADAPTIQ®

Performing the ADAPTIQ® calibration	22
---	----

Advanced Features

Alternate setup method.....	24
Disabling Wi-Fi® capability	25
Re-enabling Wi-Fi capability.....	25

Care and Maintenance

Adding a Wi-Fi® network.....	26
Troubleshooting	26
Cleaning.....	28
Customer service.....	28
Limited warranty information.....	28

Technical Information

SoundTouch™ Acoustimass® Module.....	29
Jewel Cube® Speakers.....	29
SoundTouch™ wireless adapter.....	29

Appendices

Appendix A: Acoustimass® connector panel	30
Appendix B: Wall mounting the SoundTouch™ wireless adapter.....	31
Appendix C: Wall mounting the SoundTouch™ controller	32
Appendix D: Using a desktop computer to connect to the network.....	33

Introducing SoundTouch™ from Bose®

With SoundTouch™, you can stream Internet radio, music services, and your music library. If you have Wi-Fi® at home, you're ready to enjoy your favorite music in any room or outdoor space that you want.

Key Benefits

- Enjoy wireless access to Internet radio, music services, and your music library.
- Stream your favorite music easily with personalized presets.
- Works with your existing home Wi-Fi network.
- Free SoundTouch™ app for your computer, smartphone, or tablet provides more powerful control.
- Simply add additional systems at any time for a multi-room listening experience.
- Wide selection of Bose® audio systems lets you choose the right solution for any room or outdoor space.

Introduction

About your SoundTouch™ music system

The SoundTouch™ Stereo JC Wi-Fi® music system provides an elegant way to bring high quality sound wirelessly into any room. Use the free SoundTouch™ app to set up and control your system. See “Adding the system to your Wi-Fi network” on page 10.

System features

- Acoustimass® module and Jewel Cube® speakers for superior, clear sound.
- SoundTouch™ controller provides control from up to 70 feet (21 m) away.
- Six presets deliver your music with just one touch.
- SoundTouch™ wireless adapter enables Wi-Fi access to your home network.
- An Ethernet connector enables wired access to your home network.
- Stream your music via AirPlay from your Apple devices.
- USB connectors for network setup.*

**The USB connectors on the back of the system (SETUP A and SETUP B) are for setup only. The connectors are not designed to charge smartphones, tablets, or similar devices.*

Unpacking the system

Carefully unpack the carton and confirm that the following parts are included.

Note: Do not connect any cables to the system until after you have launched the SoundTouch™ app. See “Connecting the system to your home Wi-Fi® network” on page 11.

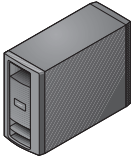

Acoustimass® module

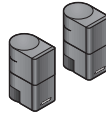

Jewel Cube® speakers



Acoustimass® module rubber feet



Rubber speaker feet



ADAPTiQ® headset



Speaker cables



 AC power cord



USB cable (setup only)

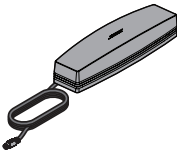

SoundTouch™ wireless adapter

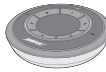

SoundTouch™ controller

Save the carton and packing materials for transporting or storing the system.

CAUTION: To avoid danger of suffocation, keep the plastic bags out of the reach of children.

 The SoundTouch™ Stereo JC Wi-Fi music system includes the appropriate AC (mains) power cord for your region. Use only the supplied AC (mains) power cord. If it does not fit your AC power (mains) outlet, DO NOT alter the plug in any way. Contact Bose customer service for assistance.

Note: If part of the system is damaged, do not use it. Contact your authorized Bose dealer or Bose customer service. Please refer to the contact list in the carton for contact information.

Setting up the System

Adding the system to your Wi-Fi® network

Tip: A laptop is the preferred method for connecting to the network. If you must use a desktop computer, see “Appendix D: Using a desktop computer to connect to the network” on page 33.

Before you can use the SoundTouch™ system, you must install the SoundTouch™ app onto a computer that is on your home network. Next, you will use the app to connect the system to the network. The app guides you through the setup process.

Make sure you follow the instructions on your computer.

Note: If you have already set up SoundTouch™ for another system, just launch the app and click **EXPLORE > SETTINGS > Systems > ADD SYSTEM** to add another system.

Installing the SoundTouch™ app

1. From a computer that is on your Wi-Fi network, open a browser and go to:

http://www.Bose.com/soundtouch_app

Tip: If you want SoundTouch™ to play your iTunes® or Windows Media® Player music library, use the computer where your music library is stored.

http://www.Bose.com/soundtouch_app



2. Download and install the SoundTouch™ app onto your computer.

You are now ready to connect the system to your network.

Note: Do not connect any cables to the system until the app instructs you to connect the cables.

Connecting the system to your home Wi-Fi® network

1. Launch the app by double-clicking the SoundTouch™ app icon.
The first time the app launches, it guides you through setting up the system on your Wi-Fi network. The app instructs you to connect the system.
2. Place the Acoustimass® module on a sturdy surface, close to an AC (mains) power source.
3. Connect the wireless adapter to the **Bose® link** connector on the back of the Acoustimass® module.

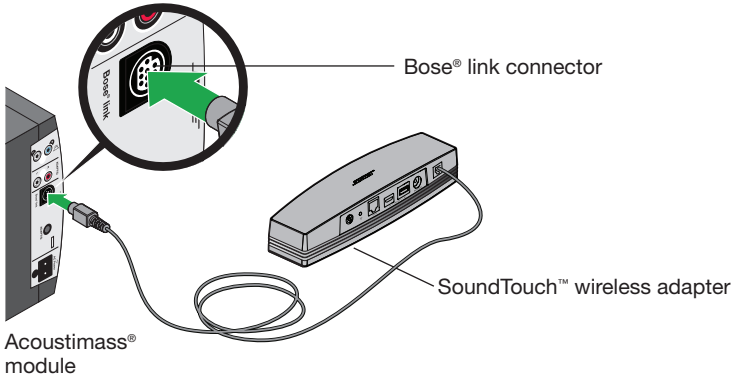

4. When prompted by the app, plug the power cord into the **AC POWER** connector on the back of the Acoustimass® module.

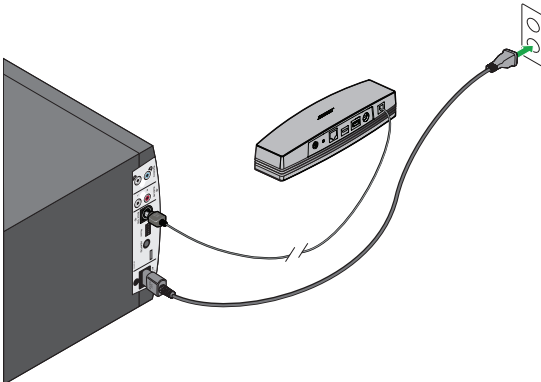

5. Plug the other end of the power cord into AC (mains) power.

Setting up the System

- When prompted by the app, plug the small end of the USB cable into the **SETUP A** connector on the SoundTouch™ wireless adapter.

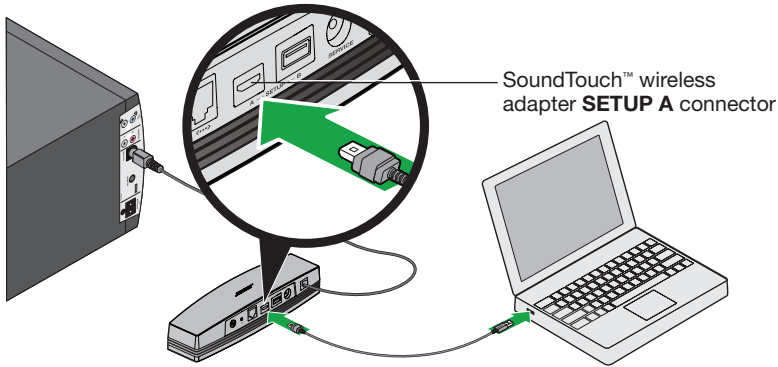

- Plug the other end of the USB cable into a USB port on your computer.
The app instructs you to enter your network credentials.
- Follow the instructions on your computer to complete setup, including creating a SoundTouch™ account, locating your music library, signing in to music services, exploring music, personalizing your presets, and connecting to the SoundTouch™ controller.
- When finished, disconnect the Acoustimass® module from AC (mains) power and prepare to connect the speakers.
When you move the system to its permanent location and reconnect it to AC (mains) power, the system reconnects to your network.

Placing the speakers

What you need:

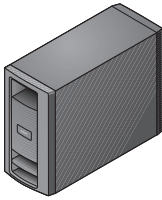

Acoustimass®
module

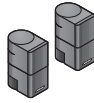

Jewel Cube®
speakers



Rubber feet for Acoustimass® module
and Jewel Cube® speakers

CAUTION: Vibration can cause speakers to move, particularly on smooth surfaces like marble, glass, or highly-polished wood. To reduce the chance of movement, Bose® recommends attaching the rubber speaker feet (included) to the bottom of the speakers.

Note: You can mount Jewel Cube® speakers on a wall or on floor stands. To purchase wall mounting brackets or floor stands, contact your local Bose dealer or visit www.Bose.com.

1. Place the Jewel Cube® speakers on a sturdy, level surface; one to your left and one to your right:
 - 6-12 feet (1.8-3.6 m) apart
 - At about ear height when seated
 - Within 20 feet (6.1 m) (maximum speaker cable length) from the Acoustimass® module
 - Near the front edge of the shelf, if placed in an enclosed bookcase
 - With one cube of each speaker aimed forward into the room and the other aimed at a side wall to create reflected sound

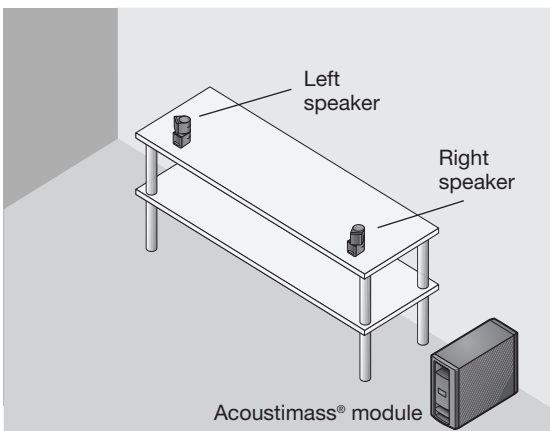

Setting up the System

CAUTIONS:

- Do not stand the module on its front or back end.
 - Do not put electronic media such as video or audio tapes on or next to the module for long periods of time. The magnetic field surrounding the module may erase some or all of the recorded material.
 - Do not block the ventilation openings on the module. This can cause it to overheat.
-

2. Place the Acoustimass® module on the floor at the same end of the room as the Jewel Cube® speakers:
 - Standing upright (BEST) or laying on either side (ALTERNATE)
 - With the front opening facing into the room
 - Close to an AC (mains) outlet
 - At least 18 inches (45 cm) from any TV to avoid magnetic interference with the TV image. Move it farther away if you still notice interference.

Note: When placing the module on bare floors, attach the rubber feet (included) to the bottom of the module for stability and to protect the floor.

Connect the speakers

What you need:

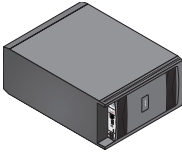

Acoustimass®
Module



Speaker
cables

Note: See “Appendix A: Acoustimass® connector panel” on page 30 for details.

1. Lay the Acoustimass® module on its side. Insert the left (L, gray) speaker cable plug into the left (L, gray) connector on the Acoustimass® module.
2. Insert the other end of the left (L, gray) speaker cable into the left Jewel Cube® speaker connector.
3. Insert the right (R, blue) speaker cable plug into the right (R, blue) connector on the Acoustimass® module.
4. Insert the other end of the right (R, blue) speaker cable into the right Jewel Cube® speaker connector.
5. Reconnect the Acoustimass® module power cord to AC (mains) power.

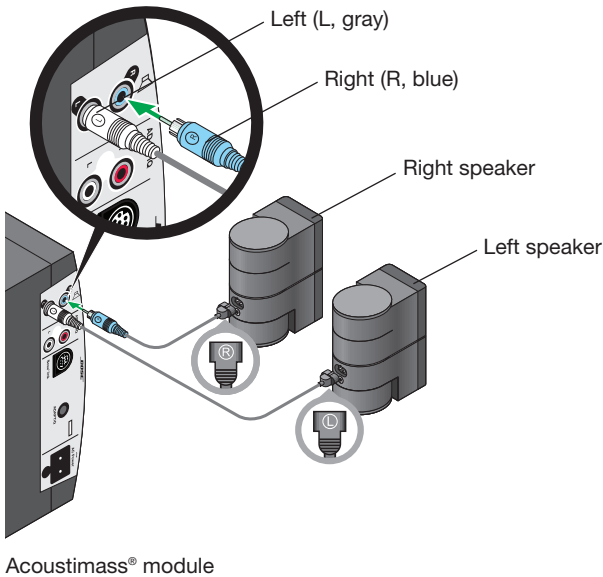

Acoustimass® module

Setting up the System

Placing the SoundTouch™ wireless adapter

The SoundTouch™ wireless adapter provides the network connection for the SoundTouch™ Stereo JC Wi-Fi® music system. It must remain in range of the Wi-Fi router, and within 70 feet (21 m) of the SoundTouch™ controller.

To keep interference to a minimum and to increase the strength of the Wi-Fi signal, place the wireless adapter outside of and away from metal cabinets, away from other audio/video components, and away from direct heat sources.

See page 31 for wall mounting instructions.

Using the SoundTouch™ app

The SoundTouch™ app is a software application that enables you to control the system from your computer, smartphone, or tablet. Using the app, your smart device acts as a rich remote for your SoundTouch™ system.

The app enables you to manage your system settings, explore local and global Internet radio stations, set and change presets, stream music to the system, view what is playing, plus much more.

After you set up the system on your network using the SoundTouch™ app, you are ready to explore streaming music and to personalize your presets.

Getting help

If you need more information on using the system, use Help Tips or Online help.

Help Tips

After setup is complete, helpful tips appear on the screen, based on the task you are trying to complete. These tips instruct you how to use the system, including how to personalize your presets.

To activate the tips

If you have deactivated tips, follow these instructions to re-activate tips.

1. Launch the SoundTouch™ app and click **EXPLORE > SETTINGS > Help Tips**.
2. Slide the SHOW TIPS slider to ON.

Online help

For information about using SoundTouch™:

1. Click **EXPLORE > HELP** in the app.
2. Browse through the help topics.

Controlling the System using the App

Downloading the app for your mobile device

Bose® offers a free mobile version of the SoundTouch™ app so you can control the system from your smartphone or tablet.

To install the app for your smartphone or tablet:

- For iOS users: download the SoundTouch™ controller app from the App Store.
- For Android™ users: download the SoundTouch™ controller app from the Google Play™ Store.

Controlling the system from another computer

Once you set up the SoundTouch™ system on your home Wi-Fi® network, you can control the system from any computer on the same network.

1. On the computer where you want to control the system, open a browser and go to:

http://www.Bose.com/soundtouch_app

2. Download, install, and launch the SoundTouch™ app.

The sign-in screen appears.

You are ready to sign in to your SoundTouch™ account.

Playing music with the SoundTouch™ controller

During the setup process, you were prompted to connect the SoundTouch™ controller to the system. If your SoundTouch™ controller is not connected, launch the SoundTouch™ app and click **EXPLORE > SETTINGS > Systems**, select your system, and click **CONNECT SOUNDTOUCH CONTROLLER**.

You can use the SoundTouch™ controller to play and manage your presets.

Note: The SoundTouch™ controller must be within 70 feet (21 m) of the SoundTouch™ wireless adapter in wood-construction homes. In concrete, stucco or brick homes, the range will likely be less and may vary. The number of other active wireless devices in the home may affect range. Ideally, there should be no more than one wall or ceiling between the controller and the wireless adapter.

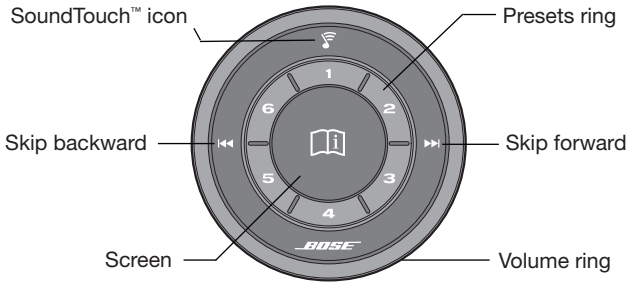

Using the SoundTouch™ controller

- Press a preset to play it. Press and hold a preset to personalize it.
- Move your finger around the Presets ring to view presets.
- Turn the Volume ring to adjust the volume.
- Touch **⏮** or **⏭** to skip through content.
- Press and hold the screen to turn the SoundTouch™ system on and off.
- Press the screen to play or pause music.
- Touch and hold the SoundTouch™ icon to disconnect the controller from a system. To connect to another system, refer to the help system in the app.

Note: If the controller is in power saving mode, wave your hand within 6 in. (15 cm) above the screen to turn it on.

Using the System

Playing an AirPlay stream from an AirPlay compatible device

In addition to playing content from Internet radio, music services, and your music library, you can also stream audio from an AirPlay device on the same Wi-Fi® network.

1. Start a music app on your AirPlay device.
Tip: Adjust the volume on the AirPlay device to 75 percent of maximum to ensure optimal volume control from the SoundTouch™ Stereo JC Wi-Fi music system.
2. On the device, tap or click  and select the SoundTouch™ system name (assigned during setup).
3. Start playing music from a music app.

Getting system information

The Wi-Fi adapter shows system information via the Wi-Fi indicator.

SoundTouch™ wireless adapter Wi-Fi indicator

The SoundTouch™ wireless adapter is powered by the Acoustimass® module. The Wi-Fi indicator is located on the connector panel.

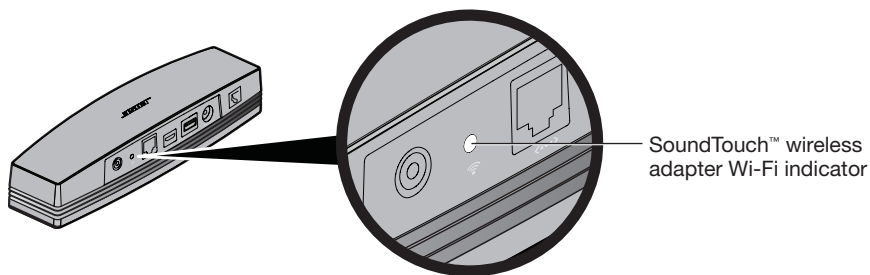

Indicator activity	System state
Blinking white	Connecting to Wi-Fi network
Solid white	System on and connected to Wi-Fi network
Solid amber	System in setup mode
Blinking slow amber	Disconnected from Wi-Fi network
Blinking fast amber	Firmware error - call Bose service
Off	Wi-Fi networking disabled or system connected to Ethernet

How presets work

You can personalize six presets to your favorite streaming music services, stations, playlists, artists, albums, or songs from your music library. You can access your music at any time with a simple touch of a button on the SoundTouch™ controller.

Tip: You can also access your presets using the SoundTouch™ app on your computer, smartphone, or tablet. See “Using the SoundTouch™ app” on page 17.

What you need to know

- You can set presets from the app, or from the SoundTouch™ controller.
- If the preset source is your iTunes or Windows Media Player® music library, ensure the computer storing your music library is on and connected to the same network as the SoundTouch™ system.

Playing a preset

Once you personalize your presets using the app, press a preset on the SoundTouch™ controller to play it. If you have not set your presets, launch the app and set your presets. For help, refer to the Help system in the app.

When music plays on the system, information appears on the controller’s screen, which may include an icon, song, or station depending on the source.

Setting a preset

This section describes how to set and change a preset from the SoundTouch™ controller Presets ring.

Note: For information on using the SoundTouch™ app to set and change your presets, refer to the Help system in the app.

To set a preset

1. Stream music to the system using the app.
2. While the music is playing, press and hold a preset on the SoundTouch™ controller (about 2 seconds).

A New Preset Assigned message appears on the screen.

To change a preset

Follow the instructions in “To set a preset.”

Performing the ADAPTiQ® calibration

What you need:

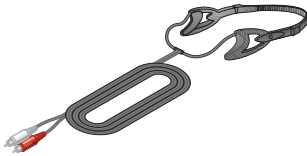

ADAPTiQ® headset

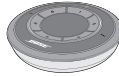

SoundTouch™ controller

The ADAPTiQ® audio calibration system customizes the sound of your system to the acoustics of your listening area.

Note: You must complete SoundTouch™ setup before performing ADAPTiQ® audio calibration. See “Adding the system to your Wi-Fi® network” on page 10.

To perform a calibration, you need about ten minutes when the room is quiet. While wearing the special headset, the system prompts you to sit in five different locations in your listening area as the system takes measurements in each one. Audio prompts from the system guide you through the process.

1. Plug the ADAPTiQ® headset into the **Audio IN** connectors in the back of the Acoustimass® module. Be sure to match the colors, red-to-red and white-to-white.

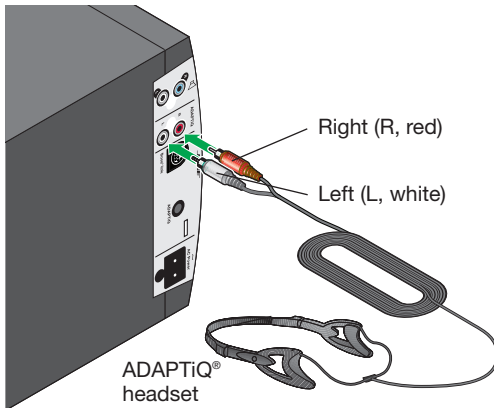

2. Put the headset on your head so the left and right sensors rest above your ears. This headset allows the system to hear exactly what you hear.



3. Press and release **ADAPTiQ** on the Acoustimass® module connector panel. The system announces the selected language.

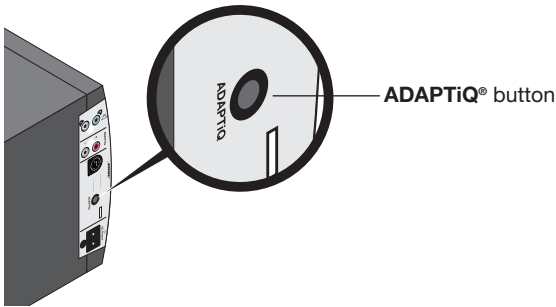

To select a different language, press **ADAPTiQ** repeatedly until you hear the language you want.

4. Place the module in its final position and orientation (standing on its feet or laying on its side). Make sure the opening at the front of the module faces into the room.
5. Click the screen on the SoundTouch™ controller to continue in the selected language.

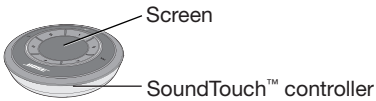

6. Follow the audio prompts to complete the process.

During the process:

- If you get interrupted and are temporarily called away from the system, you can return within ten minutes and continue. After ten minutes, the system cancels the calibration process and returns to normal operation, leaving your system unchanged.
- To cancel and leave your system unchanged, press and release the **ADAPTiQ** button.
- To reset the system to factory settings, press and hold the **ADAPTiQ** button until you hear a confirmation message.

Advanced Features

Alternate setup method

Using this method you can set up your SoundTouch™ system by first joining its own built-in Wi-Fi® network, and then connecting to your home Wi-Fi network.

Note: You may use this method to set up your system as an AirPlay device only. To access the benefits of SoundTouch™, such as streaming Internet radio and your music services, you must finish setup using the SoundTouch™ app (see page 11).

1. On the back of the SoundTouch™ wireless adapter, press and hold the Control button for 2-6 seconds. When the amber Wi-Fi indicator blinks, release the Control button. The Wi-Fi indicator should be solid amber.

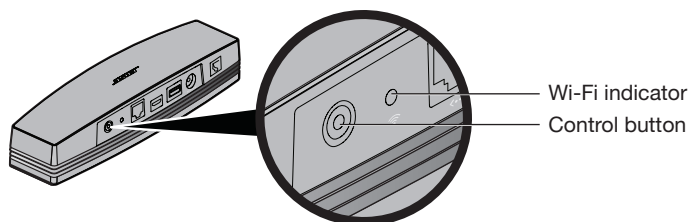

2. On your computer, tablet or smartphone, activate Wi-Fi and join the **Bose® SoundTouch™ Wi-Fi** network.
 3. Open a browser and type: **http://192.168.1.1** in the address field.
The Wi-Fi setup window appears on the screen.
 4. Select your home Wi-Fi network from the drop-down list.
 5. Enter your password (if required) and tap or click **Connect**.
The system attempts to connect to your home Wi-Fi network.
The SoundTouch™ wireless adapter Wi-Fi indicator temporarily blinks white and turns solid white when connected to the network.
- Note:** It may take a minute or two for the Wi-Fi indicator to turn from solid amber to white.
6. On your computer, tablet, or smartphone, return to the Wi-Fi control panel and rejoin your home Wi-Fi network.
 7. Once the system is on the network, follow these steps to complete setup:
 - A. Download and launch the SoundTouch™ app.
 - B. On the SOUNDTOUCH™ SYSTEM SETUP screen, select this option:
IT IS ALREADY CONNECTED.

Note: For more information on setup, see “Installing the SoundTouch™ app” on page 10.

Disabling Wi-Fi® capability

The SoundTouch™ wireless adapter has built-in Wi-Fi capability that enables wireless connectivity and AirPlay.

1. Press and hold the Control button on the back of the SoundTouch™ wireless adapter for 6-10 seconds.
2. When the Wi-Fi indicator turns off, release the Control button.

Re-enabling Wi-Fi capability

To enable Wi-Fi, press the Control button on the back of the SoundTouch™ wireless adapter.

Care and Maintenance

Adding a Wi-Fi® network

If your network information has changed, or to connect your system to another network, you must add the new network information in the app and then connect the system.

1. Launch the SoundTouch™ app.
2. Click **EXPLORE > SETTINGS > Systems**.
3. Select the system.
4. Click **CONNECT TO A WI-FI NETWORK**.
5. Follow the instructions on your computer.

Troubleshooting

For more troubleshooting information, refer to the Help system in the SoundTouch™ app.

Problem	What to do
Cannot complete network setup	<ul style="list-style-type: none">• Make sure the SoundTouch™ wireless adapter is plugged into the Bose® link connector and the Acoustimass® module is connected to AC (mains) power.• Ensure network name and password are correct.• Ensure network service is available and system and computer are on the same network.• Move system closer to wireless router or network access point.• Stop other audio or video streaming applications.• Close app, disconnect all cables, and restart setup process.
Cannot connect to network	<ul style="list-style-type: none">• If your network has changed or to connect your system to another network, see “Adding a Wi-Fi network”.• Try connecting to the network using an Ethernet cable.
Intermittent or no audio from SoundTouch™	<ul style="list-style-type: none">• Make sure the SoundTouch™ wireless adapter is plugged into the Bose® link connector.• Move the SoundTouch™ wireless adapter away from possible interference such as microwaves, cordless phones, metal cabinets, or other metal objects, etc.• Stop other audio or video streaming applications.• Ensure system is powered and connected to the same network as the computer.• Move system or audio source closer to wireless router or network access point.• Ensure system volume is not muted or too low.• Unplug the power cord; reconnect after one minute.
Cannot hear an AirPlay stream	<ul style="list-style-type: none">• Ensure system and AirPlay device are connected to the same network.• Ensure AirPlay device is playing; increase its volume.• Ensure system is selected in the AirPlay menu of the device.• Move AirPlay device away from possible interference and closer to the wireless router or network access point. <p>Note: Proximity of the AirPlay device to the system is not important, only to the wireless router or network access point.</p>

Care and Maintenance

Problem	What to do
SoundTouch™ controller response to commands is intermittent	<ul style="list-style-type: none"> • Replace the batteries. • Move it a short distance and try again. In some buildings, you may experience spots where the remote control will not operate effectively. • Make sure the cord that connects the power supply to the Acoustimass® module (which contains the remote antenna) is straightened and separated from other power cords. • Try moving the Acoustimass® module a few feet to see if this provides a better response.
There is no sound	<ul style="list-style-type: none"> • Make sure the Acoustimass® module is plugged into power, and the wireless adapter is connected to the Bose® link connector. • Make sure the speaker cable plugs are pushed all the way into the Jewel Cube® connectors. • Make sure you have selected a source. • Increase the system volume. • Press the SoundTouch™ controller screen to unpause the system.
Neither speaker plays	<ul style="list-style-type: none"> • Make sure the Acoustimass® module is connected to AC (mains) power. • Make sure the plug is inserted fully and the AC (mains) power outlet is powered. • Make sure content is selected via the SoundTouch™ app. • Disconnect the SoundTouch™ wireless adapter cable from the Acoustimass® module. Disconnect AC power from the Acoustimass® module for three minutes. Reconnect the SoundTouch™ wireless adapter. Reconnect power to the Acoustimass® module.
Only one speaker plays	<ul style="list-style-type: none"> • Check wires connected to the speaker that does not play. • Make sure the wires are in good condition and are firmly connected at both ends.
One speaker still does not play	<ul style="list-style-type: none"> • Disconnect the wires from the speaker and from the Acoustimass® module. Disconnect the other cable from its speaker, and connect that end of the cable to the speaker that does not play. If the speaker still does not play, the problem may be in the speaker. If the speaker now plays, continue checking for the source of the problem. • Disconnect the same cable from the Acoustimass® module. Connect it to the other output on the Acoustimass® module. If the speaker plays, the problem may be in the original cable that was connected to that speaker.
Right and left stereo channels are heard on the wrong speakers	<ul style="list-style-type: none"> • Make sure the cable connected to the SPEAKER OUTPUTS L at the amplifier are connected to the speaker on the left in your listening area. • Make sure the cable connected to the SPEAKER OUTPUTS R at the amplifier are connected to the speaker on the right in your listening area.
Interference	<ul style="list-style-type: none"> • Make sure the speaker wires are firmly inserted in the back of the speakers and on the Acoustimass® module connector panel. • Make sure the SoundTouch™ wireless adapter is away from metal objects, other audio/video components, and direct heat sources.

Care and Maintenance

Cleaning

To clean the SoundTouch™ Stereo JC Wi-Fi® music system, wipe the enclosures using a soft, dry cloth. You can also lightly vacuum the grille on the speakers.

- Do not use solvents, chemicals, or sprays.
- Do not allow liquids to spill or objects to drop into any openings.

Customer service

For additional help using the system, contact Bose customer service. See the contact list included with your SoundTouch™ Stereo JC Wi-Fi music system.

Limited warranty information

Your SoundTouch™ Stereo JC Wi-Fi music system is covered by a limited warranty. Details of the limited warranty are provided on the product registration card included in the carton. Please refer to the card for instructions on how to register. Failure to do so will not affect your limited warranty rights.

SoundTouch™ Acoustimass® Module

Dimensions and Weight

- 8.0 in. wide x 21.7 in. deep x 13.0 in. high (20.7 cm x 55.2 cm x 33.2 cm)
- 26.2 lb (11.9 kg)

Power rating

100-120/220-240V ~ 50/60Hz 350W

Power consumption

(OFF mode): <=4W

Temperature range

32° F to 104° F (0° C to 40° C)

Jewel Cube® Speakers

Dimensions and weight

- 2.2 in. wide x 3.2 in. deep x 4.4 in. high (5.6 cm x 8.1 cm x 11.2 cm)
- 1.0 lb (0.5 kg)

Temperature range

32° F to 104° F (0° C to 40° C)

SoundTouch™ wireless adapter

Dimensions and weight

- 2½ in. wide x 9¾ in. long x 2 in. high (6.4 cm x 23.8 cm x 5.1 cm)
- 12.0 oz (.34 kg)

Temperature range

32° F to 104° F (0° C to 40° C)

Appendices

Appendix A: Acoustimass® connector panel

The Acoustimass® module connector panel includes speaker connectors, the ADAPTiQ® calibration system connectors and button, and an AC power connector.

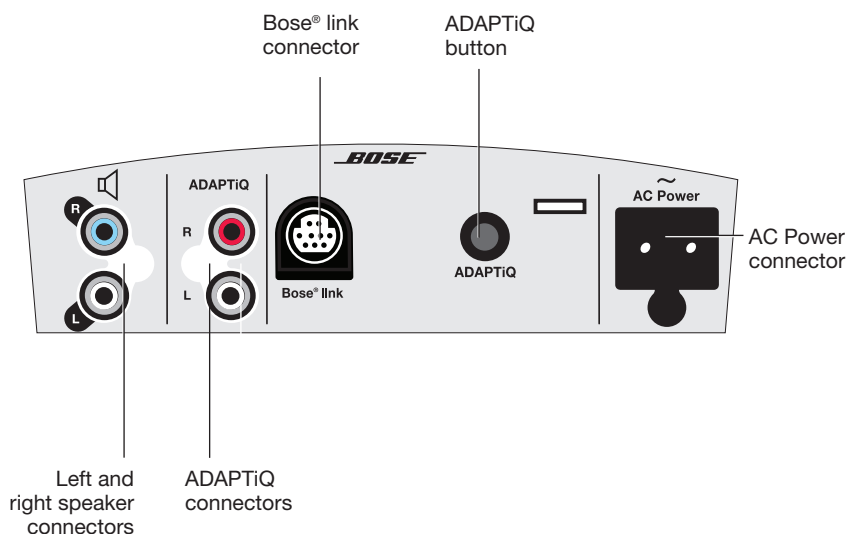

Connector	Description
Left and right speaker connectors	Used with the provided stereo cables to connect the Jewel Cube® speakers.
ADAPTiQ connectors	Used to connect the provided ADAPTiQ® headset. See “Performing the ADAPTiQ® calibration” on page 22.
Bose® link connector	Used for connecting the SoundTouch™ wireless adapter to the Acoustimass® module.
ADAPTiQ button	Used to perform the ADAPTiQ® calibration. See “Performing the ADAPTiQ® calibration” on page 22.
AC Power (mains) connector	AC power cord connector. Power is applied when the provided power cord is connected and plugged into an AC (mains) outlet. There is no on/off switch on the Acoustimass® module.

Appendix B: Wall mounting the SoundTouch™ wireless adapter



Vertical orientation

Connector panel is facing left.

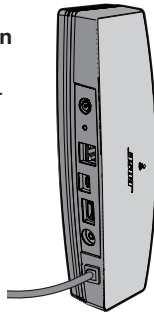

Horizontal orientation

Connector panel is facing up.



Follow these instructions to wall mount your SoundTouch™ wireless adapter. Install either vertically with the connector panel facing left, or horizontally with the connector panel facing up.

Note: Mounting hardware must be purchased separately. If the mounting hardware instructions differ from these instructions, follow the mounting hardware instructions.

- **Wood Mounting:** Mount to 1 in. (25.4 mm) or thicker wood. Drill hole with a 1/8 in. (3.17 mm) drill. Use (2) #8x1 1/4 in. (32 mm) pan-head wood screws.
- **Wallboard Mounting:** Mount to 3/8 in. (9.5 mm) or thicker wallboard. Drill pilot hole with a 3/16 in. (4.76 mm) drill. Use (2) #6-8x1 in. (25.4 mm) plastic wall anchors, and (2) #8x1 1/4 in. (32 mm) pan-head wood screws.

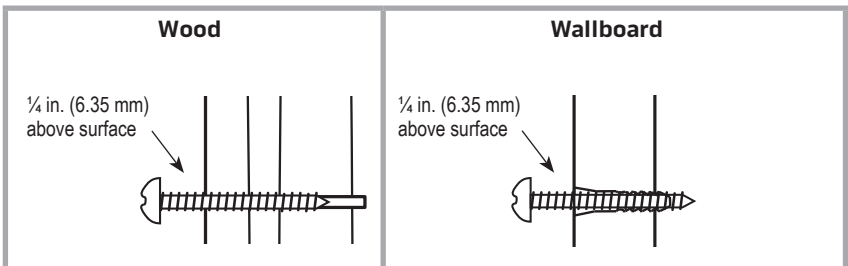

1. Mark holes on the wall 6 1/4 in. (158.7 mm) center-to-center.
2. Drill holes. Insert anchors (if used).
3. Install screws. Leave the screw heads 1/4 in. (6.35 mm) above wall surface.
4. Position SoundTouch™ wireless adapter onto screws. Press firmly into place.

Appendices

Appendix C: Wall mounting the SoundTouch™ controller



WARNING: The wall mount bracket contains magnetic material. Please contact your physician if you have any questions whether this might affect the operation of your implantable medical device.

Follow these instructions to wall mount your SoundTouch™ controller. Use the bracket as a template to mark the holes.

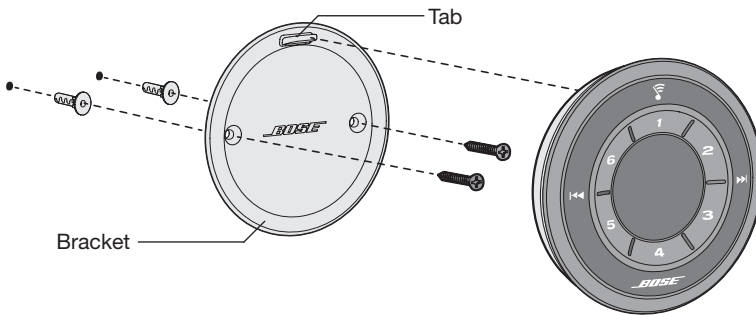

Wallboard (anchors and screws supplied):

1. Use a $\frac{9}{16}$ in. (5 mm) drill bit to drill two holes into $\frac{3}{8}$ in. (9.5 mm) or thicker wallboard.
2. Insert the provided anchors into the holes and tap lightly to secure.
3. Align the bracket (tab at top) to the anchors. Tighten the provided screws into the holes.
4. Align the latch to the bracket's tab. Attach the controller.

Wood:

1. Purchase two #6x1 in. (25.4 mm) flat-head wood screws.
2. Use a $\frac{7}{64}$ in. (2.78 mm) drill bit to drill 2 holes into $\frac{3}{4}$ in. (19 mm) or thicker wood.
3. Align the bracket (tab at top) to the holes. Tighten the screws into the holes.
4. Align the latch to the bracket's tab. Attach the controller.

Appendix D: Using a desktop computer to connect to the network

If you have a desktop computer, temporarily move the Acoustimass® module and SoundTouch™ wireless adapter near the computer to set up the W-Fi® network connection.

The diagram below shows how to temporarily set up your Acoustimass® module and SoundTouch™ wireless adapter near your desktop computer.

Once you have the components in place, follow the procedures in this guide to connect to your network. See “Adding the system to your Wi-Fi network” on page 10. After making the network connection, you can test the system to make sure everything works.

When you are done, disconnect the Acoustimass® module from your computer and AC (mains) power and permanently install the stereo system. When you reconnect the Acoustimass® module to power, it reconnects to your Wi-Fi® network.

See “Placing the speakers” on page 13.

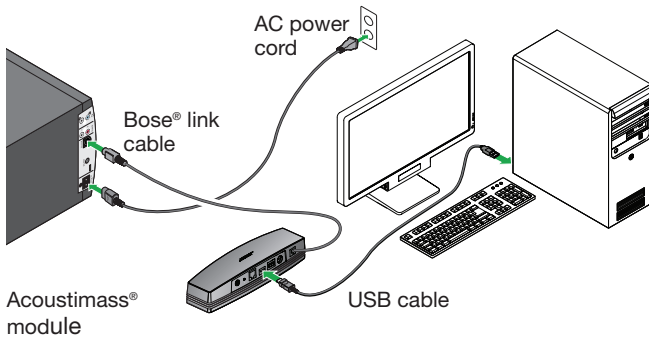

Note: Connect the USB cable to the SoundTouch™ wireless adapter only when the app instructs you to do so.



370790-0010

BOSE[®]
Better sound through research[®]

©2013 Bose Corporation, The Mountain,
Framingham, MA 01701-9168 USA
AM370790 Rev. 00