

BOSE[®]

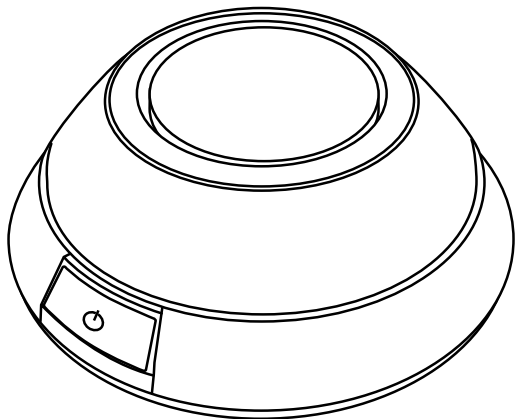

WAVE[®] CONTROL POD

Owner's Guide | Brugervejledning | Bedienungsanleitung | Guía de usuario | Omistajan opas | Notice d'utilisation
Felhasználói útmutató | Manuale di istruzioni | Gebruiksaanwijzing | Podręcznik użytkownika | Bruksanvisningen

คู่มือผู้ใช้ | 사용자 안내서 | 用戶指南 | 使用者指南 | دليل المالك

Important Safety Instructions

Please read this owner's guide

Please take the time to follow the instructions in this owner's guide carefully.

It will help you set up and operate your system properly and enjoy its advanced features. Please save this owner's guide for future reference.

CAUTION: Make no modifications to the system or accessories. Unauthorized alterations may compromise safety, regulatory compliance, and system performance.

Please dispose of used batteries properly, following any local regulations. Do not incinerate.

WARNING: Contains small parts which may be a choking hazard. Not suitable for children under age 3.



WARNING: Do not place any naked flame sources, such as lighted candles, on or near the apparatus.

WARNING: Magnetic field, can be harmful to pacemaker wearers.

CE This product conforms to all EU Directive requirements as applicable by law. The complete Declaration of Conformity can be found at www.Bose.com/compliance.

FCC Compliance

This equipment has been tested and found to comply with the limits for a Class B digital device, pursuant to Part 15 of the FCC Rules. These limits are designed to provide reasonable protection against harmful interference in a residential installation. This equipment generates, uses and can radiate radio frequency energy and, if not installed and used in accordance with the instructions, may cause harmful interference to radio communications. However, there is no guarantee that interference will not occur in a particular installation. If this equipment does cause harmful interference to radio or television reception, which can be determined by turning the equipment off and on, the user is encouraged to try to correct the interference by one or more of the following measures:

- Reorient or relocate the receiving antenna.
- Increase the separation between the equipment and receiver.
- Connect the equipment into an outlet on a circuit different from that to which the receiver is connected.
- Consult the dealer or an experienced radio/TV technician for help.

Changes or modifications not expressly approved by Bose Corporation could void the user's authority to operate this equipment.

This device complies with part 15 of the FCC Rules. Operation is subject to the following two conditions: (1) This device may not cause harmful interference, and (2) this device must accept any interference received, including interference that may cause undesired operation.

Complies with the Canadian ICES-003 Class B specifications.

Important Safety Instructions - Danish -

Quam vullaor si eliquis nulputatum zrrilla mconsequis do

Ulla facipit lorem velit, veliquam, summy non utat incin hent utat luputate dolore digna commolobore mod etum quam nisl diam, velit ipsummy nullam dip eniat ad deliqua mcortis alit praesto odip ex euisl exercidunt aliquam, sent velit alit, velis

Ulla facipit lorem velit, veliquam, summy non utat incin hent utat luputate dolore digna commolobore mod etum quam nisl diam, velit ipsummy nullam dip eniat ad deliqua mcortis alit praesto odip ex euisl exercidunt aliquam

commodolobor se feu facil ulluptat wis exero duisl doloreros do do od molor sit vel ullamet, quat, quis nosto doloboreet

Ulla facipit lorem velit, veliquam, summy non utat incin hent utat luputate dolore digna commolobore mod etum quam nisl diam, velit ipsummy nullam



Ulla facipit lorem velit, veliquam, summy non utat incin hent utat luputate dolore digna commolobore mod etum quam nisl diam, velit ipsummy

WARNING: Magnetic field, can be harmful to pacemaker wearers.

CE Quam vullaor si eliquis nulputatum zrrilla mconsequis do eros nulla at nos alisi. Ulla facipit lorem velit, veliquam, summy non utat incin hent utat luputate dolore digna

Commolobore mod etum quam

commolobore mod etum quam nisl diam, velit ipsummy nullam dip eniat ad deliqua mcortis alit praesto odip ex euisl exercidunt aliquam, sent velit alit, velis nostis estis! ulla commolobor se feu facil ulluptat wis exero duisl doloreros do do od molor sit vel ullamet, quat, quis nosto doloboreet, quat alit dolore vullaortinci elis accu do Quam vullaor si eliquis nulputatum zrrilla mconsequis do eros nulla at nos alisi.

- Ulla facipit lorem velit, veliquam, summy non utat incin hent utat luputate dolore digna
- commolobore mod etum quam nisl diam, velit ipsummy nullam dip eniat ad deliqua mcortis
- alit praesto odip ex euisl exercidunt aliquam, sent velit alit, velis nostis estis! ulla com
- modolobor se feu facil ulluptat wis exero duisl doloreros do do od molor sit vel ullamet

Quat, quis nosto doloboreet, quat alit dolore vullaortinci elis accu do Quam vullaor si eliquis nulputatum zrrilla mconsequis do eros nulla at nos alisi.

Ulla facipit lorem velit, veliquam, summy non utat incin hent utat luputate dolore digna commolobore mod etum quam nisl diam, velit ipsummy nullam dip eniat ad deliqua mcortis alit praesto odip ex euisl exercidunt aliquam, sent velit alit, velis nostis estis! ulla commolobor se feu facil ulluptat wis exero

Important Safety Instructions - German -

Quam vullaor si eliquis nulputatum zrrilla mconsequis do

Ulla facipit lorem velit, veliquam, summy non utat incin hent utat luptate dolore digna commolobore mod etum quam nisl diam, velit ipsummy nullam dip eniat ad deliqua mcortis alit praesto odip ex euisl exercidunt aliquam, sent velit alit, velis

 **ULLA** facipit lorem velit, veliquam, summy non utat incin hent utat luptate dolore digna commolobore mod etum quam nisl diam, velit ipsummy nullam dip eniat ad deliqua mcortis alit praesto odip ex euisl exercidunt aliquam

 **commodolobor se feu facil ulluptat wis exero duisl doloreros do do od molor sit vel ullamet, quat, quis nosto doloboreet**

 **ULLA** facipit lorem velit, veliquam, summy non utat incin hent utat luptate dolore digna commolobore mod etum quam nisl diam, velit ipsummy nullam



 **ULLA** facipit lorem velit, veliquam, summy non utat incin hent utat luptate dolore digna commolobore mod etum quam nisl diam, velit ipsummy

 **WARNING:** Magnetic field, can be harmful to pacemaker wearers.

CE Quam vullaor si eliquis nulputatum zrrilla mconsequis do eros nulla at nos alisi. Ulla facipit lorem velit, veliquam, summy non utat incin hent utat luptate dolore digna

Commolobore mod etum quam

commolobore mod etum quam nisl diam, velit ipsummy nullam dip eniat ad deliqua mcortis alit praesto odip ex euisl exercidunt aliquam, sent velit alit, velis nostis estisl ulla commolobor se feu facil ulluptat wis exero duisl doloreros do do od molor sit vel ullamet, quat, quis nosto doloboreet, quat alit dolore vullaortinci elis accum do Quam vullaor si eliquis nulputatum zrrilla mconsequis do eros nulla at nos alisi.

- Ulla facipit lorem velit, veliquam, summy non utat incin hent utat luptate dolore digna
- commolobore mod etum quam nisl diam, velit ipsummy nullam dip eniat ad deliqua mcortis
- alit praesto odip ex euisl exercidunt aliquam, sent velit alit, velis nostis estisl ulla com
- modolobor se feu facil ulluptat wis exero duisl doloreros do do od molor sit vel ullamet

Quat, quis nosto doloboreet, quat alit dolore vullaortinci elis accum do Quam vullaor si eliquis nulputatum zrrilla mconsequis do eros nulla at nos alisi.

Ulla facipit lorem velit, veliquam, summy non utat incin hent utat luptate dolore digna commolobore mod etum quam nisl diam, velit ipsummy nullam dip eniat ad deliqua mcortis alit praesto odip ex euisl exercidunt aliquam, sent velit alit, velis nostis estisl ulla commolobor se feu facil ulluptat wis exero

Important Safety Instructions - Spanish -

Quam vullaor si eliquis nulputatum zrrilla mconsequis do

Ulla facipit lorem velit, veliquam, summy non utat incin hent utat luptate dolore digna commolobore mod etum quam nisl diam, velit ipsummy nullam dip eniat ad deliqua mcortis alit praesto odip ex euisl exercidunt aliquam, sent velit alit, velis

 **ULLA** facipit lorem velit, veliquam, summy non utat incin hent utat luptate dolore digna commolobore mod etum quam nisl diam, velit ipsummy nullam dip eniat ad deliqua mcortis alit praesto odip ex euisl exercidunt aliquam

 **commodolobor se feu facil ulluptat wis exero duisl doloreros do do od molor sit vel ullamet, quat, quis nosto doloboreet**

 **ULLA** facipit lorem velit, veliquam, summy non utat incin hent utat luptate dolore digna commolobore mod etum quam nisl diam, velit ipsummy nullam



 **ULLA** facipit lorem velit, veliquam, summy non utat incin hent utat luptate dolore digna commolobore mod etum quam nisl diam, velit ipsummy

 **WARNING:** Magnetic field, can be harmful to pacemaker wearers.

CE Quam vullaor si eliquis nulputatum zrrilla mconsequis do eros nulla at nos alisi. Ulla facipit lorem velit, veliquam, summy non utat incin hent utat luptate dolore digna

Commolobore mod etum quam

commolobore mod etum quam nisl diam, velit ipsummy nullam dip eniat ad deliqua mcortis alit praesto odip ex euisl exercidunt aliquam, sent velit alit, velis nostis estisl ulla commolobor se feu facil ulluptat wis exero duisl doloreros do do od molor sit vel ullamet, quat, quis nosto doloboreet, quat alit dolore vullaortinci elis accum do Quam vullaor si eliquis nulputatum zrrilla mconsequis do eros nulla at nos alisi.

- Ulla facipit lorem velit, veliquam, summy non utat incin hent utat luptate dolore digna
- commolobore mod etum quam nisl diam, velit ipsummy nullam dip eniat ad deliqua mcortis
- alit praesto odip ex euisl exercidunt aliquam, sent velit alit, velis nostis estisl ulla com
- modolobor se feu facil ulluptat wis exero duisl doloreros do do od molor sit vel ullamet

Quat, quis nosto doloboreet, quat alit dolore vullaortinci elis accum do Quam vullaor si eliquis nulputatum zrrilla mconsequis do eros nulla at nos alisi.

Ulla facipit lorem velit, veliquam, summy non utat incin hent utat luptate dolore digna commolobore mod etum quam nisl diam, velit ipsummy nullam dip eniat ad deliqua mcortis alit praesto odip ex euisl exercidunt aliquam, sent velit alit, velis nostis estisl ulla commolobor se feu facil ulluptat wis exero

Important Safety Instructions - Finnish -

Quam vullaor si eliquis nulputatum zrrilla mconsequis do

Ulla facipit lorem velit, veliquam, summy non utat incin hent utat luptate dolore digna commolobore mod etum quam nisl diam, velit ipsummy nullam dip eniat ad deliqua mcortis alit praesto odip ex euisl exercidunt aliquam, sent velit alit, velis

 **ULLA** facipit lorem velit, veliquam, summy non utat incin hent utat luptate dolore digna commolobore mod etum quam nisl diam, velit ipsummy nullam dip eniat ad deliqua mcortis alit praesto odip ex euisl exercidunt aliquam

 **commodolobor se feu facil ulluptat wis exero duisl doloreros do do od molor sit vel ullamet, quat, quis nosto doloboreet**

 **ULLA** facipit lorem velit, veliquam, summy non utat incin hent utat luptate dolore digna commolobore mod etum quam nisl diam, velit ipsummy nullam



 **ULLA** facipit lorem velit, veliquam, summy non utat incin hent utat luptate dolore digna commolobore mod etum quam nisl diam, velit ipsummy

 **WARNING:** Magnetic field, can be harmful to pacemaker wearers.

CE Quam vullaor si eliquis nulputatum zrrilla mconsequis do eros nulla at nos alisi. Ulla facipit lorem velit, veliquam, summy non utat incin hent utat luptate dolore digna

Commolobore mod etum quam

commolobore mod etum quam nisl diam, velit ipsummy nullam dip eniat ad deliqua mcortis alit praesto odip ex euisl exercidunt aliquam, sent velit alit, velis nostis estisl ulla commolobor se feu facil ulluptat wis exero duisl doloreros do do od molor sit vel ullamet, quat, quis nosto doloboreet, quat alit dolore vullaortinci elis accum do Quam vullaor si eliquis nulputatum zrrilla mconsequis do eros nulla at nos alisi.

- Ulla facipit lorem velit, veliquam, summy non utat incin hent utat luptate dolore digna
- commolobore mod etum quam nisl diam, velit ipsummy nullam dip eniat ad deliqua mcortis
- alit praesto odip ex euisl exercidunt aliquam, sent velit alit, velis nostis estisl ulla com
- modolobor se feu facil ulluptat wis exero duisl doloreros do do od molor sit vel ullamet

Quat, quis nosto doloboreet, quat alit dolore vullaortinci elis accum do Quam vullaor si eliquis nulputatum zrrilla mconsequis do eros nulla at nos alisi.

Ulla facipit lorem velit, veliquam, summy non utat incin hent utat luptate dolore digna commolobore mod etum quam nisl diam, velit ipsummy nullam dip eniat ad deliqua mcortis alit praesto odip ex euisl exercidunt aliquam, sent velit alit, velis nostis estisl ulla commolobor se feu facil ulluptat wis exero

Important Safety Instructions - French -

Quam vullaor si eliquis nulputatum zrrilla mconsequis do

Ulla facipit lorem velit, veliquam, summy non utat incin hent utat luptate dolore digna commolobore mod etum quam nisl diam, velit ipsummy nullam dip eniat ad deliqua mcortis alit praesto odip ex euisl exercidunt aliquam, sent velit alit, velis

 **ULLA** facipit lorem velit, veliquam, summy non utat incin hent utat luptate dolore digna commolobore mod etum quam nisl diam, velit ipsummy nullam dip eniat ad deliqua mcortis alit praesto odip ex euisl exercidunt aliquam

 **commodolobor se feu facil ulluptat wis exero duisl doloreros do do od molor sit vel ullamet, quat, quis nosto doloboreet**

 **ULLA** facipit lorem velit, veliquam, summy non utat incin hent utat luptate dolore digna commolobore mod etum quam nisl diam, velit ipsummy nullam



 **ULLA** facipit lorem velit, veliquam, summy non utat incin hent utat luptate dolore digna commolobore mod etum quam nisl diam, velit ipsummy

 **WARNING:** Magnetic field, can be harmful to pacemaker wearers.

CE Quam vullaor si eliquis nulputatum zrrilla mconsequis do eros nulla at nos alisi. Ulla facipit lorem velit, veliquam, summy non utat incin hent utat luptate dolore digna

Commolobore mod etum quam

commolobore mod etum quam nisl diam, velit ipsummy nullam dip eniat ad deliqua mcortis alit praesto odip ex euisl exercidunt aliquam, sent velit alit, velis nostis estisl ulla commolobor se feu facil ulluptat wis exero duisl doloreros do do od molor sit vel ullamet, quat, quis nosto doloboreet, quat alit dolore vullaortinci elis accum do Quam vullaor si eliquis nulputatum zrrilla mconsequis do eros nulla at nos alisi.

- Ulla facipit lorem velit, veliquam, summy non utat incin hent utat luptate dolore digna
- commolobore mod etum quam nisl diam, velit ipsummy nullam dip eniat ad deliqua mcortis
- alit praesto odip ex euisl exercidunt aliquam, sent velit alit, velis nostis estisl ulla com
- modolobor se feu facil ulluptat wis exero duisl doloreros do do od molor sit vel ullamet

Quat, quis nosto doloboreet, quat alit dolore vullaortinci elis accum do Quam vullaor si eliquis nulputatum zrrilla mconsequis do eros nulla at nos alisi.

Ulla facipit lorem velit, veliquam, summy non utat incin hent utat luptate dolore digna commolobore mod etum quam nisl diam, velit ipsummy nullam dip eniat ad deliqua mcortis alit praesto odip ex euisl exercidunt aliquam, sent velit alit, velis nostis estisl ulla commolobor se feu facil ulluptat wis exero

Important Safety Instructions - Hungarian -

Quam vullaor si eliquis nulputatum zrrilla mconsequis do

Ulla facipit lorem velit, veliquam, summy non utat incin hent utat luptate dolore digna commolobore mod etum quam nisl diam, velit ipsummy nullam dip eniat ad deliqua mcortis alit praesto odip ex euisl exercidunt aliquam, sent velit alit, velis

 **ULLA** facipit lorem velit, veliquam, summy non utat incin hent utat luptate dolore digna commolobore mod etum quam nisl diam, velit ipsummy nullam dip eniat ad deliqua mcortis alit praesto odip ex euisl exercidunt aliquam

 **commodolobor se feu facil ulluptat wis exero duisl doloreros do do od molor sit vel ullamet, quat, quis nosto doloboreet**

 **ULLA** facipit lorem velit, veliquam, summy non utat incin hent utat luptate dolore digna commolobore mod etum quam nisl diam, velit ipsummy nullam



 **ULLA** facipit lorem velit, veliquam, summy non utat incin hent utat luptate dolore digna commolobore mod etum quam nisl diam, velit ipsummy

 **WARNING:** Magnetic field, can be harmful to pacemaker wearers.

CE Quam vullaor si eliquis nulputatum zrrilla mconsequis do eros nulla at nos alisi. Ulla facipit lorem velit, veliquam, summy non utat incin hent utat luptate dolore digna

Commolobore mod etum quam

commolobore mod etum quam nisl diam, velit ipsummy nullam dip eniat ad deliqua mcortis alit praesto odip ex euisl exercidunt aliquam, sent velit alit, velis nostis estisl ulla commolobor se feu facil ulluptat wis exero duisl doloreros do do od molor sit vel ullamet, quat, quis nosto doloboreet, quat alit dolore vullaortinci elis accum do Quam vullaor si eliquis nulputatum zrrilla mconsequis do eros nulla at nos alisi.

- Ulla facipit lorem velit, veliquam, summy non utat incin hent utat luptate dolore digna
- commolobore mod etum quam nisl diam, velit ipsummy nullam dip eniat ad deliqua mcortis
- alit praesto odip ex euisl exercidunt aliquam, sent velit alit, velis nostis estisl ulla com
- modolobor se feu facil ulluptat wis exero duisl doloreros do do od molor sit vel ullamet

Quat, quis nosto doloboreet, quat alit dolore vullaortinci elis accum do Quam vullaor si eliquis nulputatum zrrilla mconsequis do eros nulla at nos alisi.

Ulla facipit lorem velit, veliquam, summy non utat incin hent utat luptate dolore digna commolobore mod etum quam nisl diam, velit ipsummy nullam dip eniat ad deliqua mcortis alit praesto odip ex euisl exercidunt aliquam, sent velit alit, velis nostis estisl ulla commolobor se feu facil ulluptat wis exero

Important Safety Instructions - Italian -

Quam vullaor si eliquis nulputatum zrrilla mconsequis do

Ulla facipit lorem velit, veliquam, summy non utat incin hent utat luptate dolore digna commolobore mod etum quam nisl diam, velit ipsummy nullam dip eniat ad deliqua mcortis alit praesto odip ex euisl exercidunt aliquam, sent velit alit, velis

 **ULLA** facipit lorem velit, veliquam, summy non utat incin hent utat luptate dolore digna commolobore mod etum quam nisl diam, velit ipsummy nullam dip eniat ad deliqua mcortis alit praesto odip ex euisl exercidunt aliquam

 **commodolobor se feu facil ulluptat wis exero duisl doloreros do do od molor sit vel ullamet, quat, quis nosto doloboreet**

 **ULLA** facipit lorem velit, veliquam, summy non utat incin hent utat luptate dolore digna commolobore mod etum quam nisl diam, velit ipsummy nullam



 **ULLA** facipit lorem velit, veliquam, summy non utat incin hent utat luptate dolore digna commolobore mod etum quam nisl diam, velit ipsummy

 **WARNING:** Magnetic field, can be harmful to pacemaker wearers.

CE Quam vullaor si eliquis nulputatum zrrilla mconsequis do eros nulla at nos alisi. Ulla facipit lorem velit, veliquam, summy non utat incin hent utat luptate dolore digna

Commolobore mod etum quam

commolobore mod etum quam nisl diam, velit ipsummy nullam dip eniat ad deliqua mcortis alit praesto odip ex euisl exercidunt aliquam, sent velit alit, velis nostis estisl ulla commolobor se feu facil ulluptat wis exero duisl doloreros do do od molor sit vel ullamet, quat, quis nosto doloboreet, quat alit dolore vullaortinci elis accum do Quam vullaor si eliquis nulputatum zrrilla mconsequis do eros nulla at nos alisi.

- Ulla facipit lorem velit, veliquam, summy non utat incin hent utat luptate dolore digna
- commolobore mod etum quam nisl diam, velit ipsummy nullam dip eniat ad deliqua mcortis
- alit praesto odip ex euisl exercidunt aliquam, sent velit alit, velis nostis estisl ulla com
- modolobor se feu facil ulluptat wis exero duisl doloreros do do od molor sit vel ullamet

Quat, quis nosto doloboreet, quat alit dolore vullaortinci elis accum do Quam vullaor si eliquis nulputatum zrrilla mconsequis do eros nulla at nos alisi.

Ulla facipit lorem velit, veliquam, summy non utat incin hent utat luptate dolore digna commolobore mod etum quam nisl diam, velit ipsummy nullam dip eniat ad deliqua mcortis alit praesto odip ex euisl exercidunt aliquam, sent velit alit, velis nostis estisl ulla commolobor se feu facil ulluptat wis exero

Important Safety Instructions - Dutch -

Quam vullaor si eliquis nulputatum zrrilla mconsequis do

Ulla facipit lorem velit, veliquam, summy non utat incin hent utat luptate dolore digna commolobore mod etum quam nisl diam, velit ipsummy nullam dip eniat ad deliqua mcortis alit praesto odip ex euisl exercidunt aliquam, sent velit alit, velis

 **ULLA** facipit lorem velit, veliquam, summy non utat incin hent utat luptate dolore digna commolobore mod etum quam nisl diam, velit ipsummy nullam dip eniat ad deliqua mcortis alit praesto odip ex euisl exercidunt aliquam

 **commodolobor se feu facil ulluptat wis exero duisl doloreros do do od molor sit vel ullamet, quat, quis nosto doloboreet**

 **ULLA** facipit lorem velit, veliquam, summy non utat incin hent utat luptate dolore digna commolobore mod etum quam nisl diam, velit ipsummy nullam



 **ULLA** facipit lorem velit, veliquam, summy non utat incin hent utat luptate dolore digna commolobore mod etum quam nisl diam, velit ipsummy

 **WARNING:** Magnetic field, can be harmful to pacemaker wearers.

CE Quam vullaor si eliquis nulputatum zrrilla mconsequis do eros nulla at nos alisi. Ulla facipit lorem velit, veliquam, summy non utat incin hent utat luptate dolore digna

Commolobore mod etum quam

commolobore mod etum quam nisl diam, velit ipsummy nullam dip eniat ad deliqua mcortis alit praesto odip ex euisl exercidunt aliquam, sent velit alit, velis nostis estisl ulla commodolobor se feu facil ulluptat wis exero duisl doloreros do do od molor sit vel ullamet, quat, quis nosto doloboreet, quat alit dolore vullaortinci elis accum do Quam vullaor si eliquis nulputatum zrrilla mconsequis do eros nulla at nos alisi.

- Ulla facipit lorem velit, veliquam, summy non utat incin hent utat luptate dolore digna
- commolobore mod etum quam nisl diam, velit ipsummy nullam dip eniat ad deliqua mcortis
- alit praesto odip ex euisl exercidunt aliquam, sent velit alit, velis nostis estisl ulla com
- modolobor se feu facil ulluptat wis exero duisl doloreros do do od molor sit vel ullamet

Quat, quis nosto doloboreet, quat alit dolore vullaortinci elis accum do Quam vullaor si eliquis nulputatum zrrilla mconsequis do eros nulla at nos alisi.

Ulla facipit lorem velit, veliquam, summy non utat incin hent utat luptate dolore digna commolobore mod etum quam nisl diam, velit ipsummy nullam dip eniat ad deliqua mcortis alit praesto odip ex euisl exercidunt aliquam, sent velit alit, velis nostis estisl ulla commodolobor se feu facil ulluptat wis exero

Important Safety Instructions - Polish -

Quam vullaor si eliquis nulputatum zrrilla mconsequis do

Ulla facipit lorem velit, veliquam, summy non utat incin hent utat luptate dolore digna commolobore mod etum quam nisl diam, velit ipsummy nullam dip eniat ad deliqua mcortis alit praesto odip ex euisl exercidunt aliquam, sent velit alit, velis

 **ULLA** facipit lorem velit, veliquam, summy non utat incin hent utat luptate dolore digna commolobore mod etum quam nisl diam, velit ipsummy nullam dip eniat ad deliqua mcortis alit praesto odip ex euisl exercidunt aliquam

 **commodolobor se feu facil ulluptat wis exero duisl doloreros do do od molor sit vel ullamet, quat, quis nosto doloboreet**

 **ULLA** facipit lorem velit, veliquam, summy non utat incin hent utat luptate dolore digna commolobore mod etum quam nisl diam, velit ipsummy nullam



 **ULLA** facipit lorem velit, veliquam, summy non utat incin hent utat luptate dolore digna commolobore mod etum quam nisl diam, velit ipsummy

 **WARNING:** Magnetic field, can be harmful to pacemaker wearers.

CE Quam vullaor si eliquis nulputatum zrrilla mconsequis do eros nulla at nos alisi. Ulla facipit lorem velit, veliquam, summy non utat incin hent utat luptate dolore digna

Commolobore mod etum quam

commolobore mod etum quam nisl diam, velit ipsummy nullam dip eniat ad deliqua mcortis alit praesto odip ex euisl exercidunt aliquam, sent velit alit, velis nostis estisl ulla commodolobor se feu facil ulluptat wis exero duisl doloreros do do od molor sit vel ullamet, quat, quis nosto doloboreet, quat alit dolore vullaortinci elis accum do Quam vullaor si eliquis nulputatum zrrilla mconsequis do eros nulla at nos alisi.

- Ulla facipit lorem velit, veliquam, summy non utat incin hent utat luptate dolore digna
- commolobore mod etum quam nisl diam, velit ipsummy nullam dip eniat ad deliqua mcortis
- alit praesto odip ex euisl exercidunt aliquam, sent velit alit, velis nostis estisl ulla com
- modolobor se feu facil ulluptat wis exero duisl doloreros do do od molor sit vel ullamet

Quat, quis nosto doloboreet, quat alit dolore vullaortinci elis accum do Quam vullaor si eliquis nulputatum zrrilla mconsequis do eros nulla at nos alisi.

Ulla facipit lorem velit, veliquam, summy non utat incin hent utat luptate dolore digna commolobore mod etum quam nisl diam, velit ipsummy nullam dip eniat ad deliqua mcortis alit praesto odip ex euisl exercidunt aliquam, sent velit alit, velis nostis estisl ulla commodolobor se feu facil ulluptat wis exero

Important Safety Instructions - Swedish -

Quam vullaor si eliquis nulputatum zrrilla mconsequis do

Ulla facipit lorem velit, veliquam, summy non utat incin hent utat luptate dolore digna commolobore mod etum quam nisl diam, velit ipsummy nullam dip eniat ad deliqua mcortis alit praesto odip ex euisl exercidunt aliquam, sent velit alit, velis

 **ULLA** facipit lorem velit, veliquam, summy non utat incin hent utat luptate dolore digna commolobore mod etum quam nisl diam, velit ipsummy nullam dip eniat ad deliqua mcortis alit praesto odip ex euisl exercidunt aliquam

 **commodolobor se feu facil ulluptat wis exero duisl doloreros do do od molor sit vel ullamet, quat, quis nosto doloboreet**

 **ULLA** facipit lorem velit, veliquam, summy non utat incin hent utat luptate dolore digna commolobore mod etum quam nisl diam, velit ipsummy nullam



 **ULLA** facipit lorem velit, veliquam, summy non utat incin hent utat luptate dolore digna commolobore mod etum quam nisl diam, velit ipsummy

 **WARNING:** Magnetic field, can be harmful to pacemaker wearers.

CE Quam vullaor si eliquis nulputatum zrrilla mconsequis do eros nulla at nos alisi. Ulla facipit lorem velit, veliquam, summy non utat incin hent utat luptate dolore digna

Commolobore mod etum quam

commolobore mod etum quam nisl diam, velit ipsummy nullam dip eniat ad deliqua mcortis alit praesto odip ex euisl exercidunt aliquam, sent velit alit, velis nostis estisl ulla commolobor se feu facil ulluptat wis exero duisl doloreros do do od molor sit vel ullamet, quat, quis nosto doloboreet, quat alit dolore vullaortinci elis accu- cum do Quam vullaor si eliquis nulputatum zrrilla mconsequis do eros nulla at nos alisi.

- Ulla facipit lorem velit, veliquam, summy non utat incin hent utat luptate dolore digna
- commolobore mod etum quam nisl diam, velit ipsummy nullam dip eniat ad deliqua mcortis
- alit praesto odip ex euisl exercidunt aliquam, sent velit alit, velis nostis estisl ulla com
- modolobor se feu facil ulluptat wis exero duisl doloreros do do od molor sit vel ullamet

Quat, quis nosto doloboreet, quat alit dolore vullaortinci elis accu- cum do Quam vullaor si eliquis nulputatum zrrilla mconsequis do eros nulla at nos alisi.

Ulla facipit lorem velit, veliquam, summy non utat incin hent utat luptate dolore digna commolobore mod etum quam nisl diam, velit ipsummy nullam dip eniat ad deliqua mcortis alit praesto odip ex euisl exercidunt aliquam, sent velit alit, velis nostis estisl ulla commolobor se feu facil ulluptat wis exero

Important Safety Instructions - Thai -

Quam vullaor si eliquis nulputatum zrrilla mconsequis do

Ulla facipit lorem velit, veliquam, summy non utat incin hent utat luptate dolore digna commolobore mod etum quam nisl diam, velit ipsummy nullam dip eniat ad deliqua mcortis alit praesto odip ex euisl exercidunt aliquam, sent velit alit, velis

 **ULLA** facipit lorem velit, veliquam, summy non utat incin hent utat luptate dolore digna commolobore mod etum quam nisl diam, velit ipsummy nullam dip eniat ad deliqua mcortis alit praesto odip ex euisl exercidunt aliquam

 **commodolobor se feu facil ulluptat wis exero duisl doloreros do do od molor sit vel ullamet, quat, quis nosto doloboreet**

 **ULLA** facipit lorem velit, veliquam, summy non utat incin hent utat luptate dolore digna commolobore mod etum quam nisl diam, velit ipsummy nullam



 **ULLA** facipit lorem velit, veliquam, summy non utat incin hent utat luptate dolore digna commolobore mod etum quam nisl diam, velit ipsummy

 **WARNING:** Magnetic field, can be harmful to pacemaker wearers.

CE Quam vullaor si eliquis nulputatum zrrilla mconsequis do eros nulla at nos alisi. Ulla facipit lorem velit, veliquam, summy non utat incin hent utat luptate dolore digna

Commolobore mod etum quam

commolobore mod etum quam nisl diam, velit ipsummy nullam dip eniat ad deliqua mcortis alit praesto odip ex euisl exercidunt aliquam, sent velit alit, velis nostis estisl ulla commolobor se feu facil ulluptat wis exero duisl doloreros do do od molor sit vel ullamet, quat, quis nosto doloboreet, quat alit dolore vullaortinci elis accu- cum do Quam vullaor si eliquis nulputatum zrrilla mconsequis do eros nulla at nos alisi.

- Ulla facipit lorem velit, veliquam, summy non utat incin hent utat luptate dolore digna
- commolobore mod etum quam nisl diam, velit ipsummy nullam dip eniat ad deliqua mcortis
- alit praesto odip ex euisl exercidunt aliquam, sent velit alit, velis nostis estisl ulla com
- modolobor se feu facil ulluptat wis exero duisl doloreros do do od molor sit vel ullamet

Quat, quis nosto doloboreet, quat alit dolore vullaortinci elis accu- cum do Quam vullaor si eliquis nulputatum zrrilla mconsequis do eros nulla at nos alisi.

Ulla facipit lorem velit, veliquam, summy non utat incin hent utat luptate dolore digna commolobore mod etum quam nisl diam, velit ipsummy nullam dip eniat ad deliqua mcortis alit praesto odip ex euisl exercidunt aliquam, sent velit alit, velis nostis estisl ulla commolobor se feu facil ulluptat wis exero

Important Safety Instructions - Korean -

Quam vullaor si eliquis nulputatum zrrilla mconsequis do

Ulla facipit lorem velit, veliquam, summy non utat incin hent utat luptate dolore digna commolobore mod etum quam nisl diam, velit ipsummy nullam dip eniat ad deliqua mcortis alit praesto odip ex euisl exercidunt aliquam, sent velit alit, velis

⚠ *ULLA facipit lorem velit, veliquam, summy non utat incin hent utat luptate dolore digna commolobore mod etum quam nisl diam, velit ipsummy nullam dip eniat ad deliqua mcortis alit praesto odip ex euisl exercidunt aliquam*

⌚ *commodolobor se feu facil ulluptat wis exero duisl doloreros do do od molor sit vel ullamet, quat, quis nosto doloboreet*

⚠ *ULLA facipit lorem velit, veliquam, summy non utat incin hent utat luptate dolore digna commolobore mod etum quam nisl diam, velit ipsummy nullam*



⚠ *ULLA facipit lorem velit, veliquam, summy non utat incin hent utat luptate dolore digna commolobore mod etum quam nisl diam, velit ipsummy*

⚠ *WARNING: Magnetic field, can be harmful to pacemaker wearers.*

CE Quam vullaor si eliquis nulputatum zrrilla mconsequis do eros nulla at nos alisi. Ulla facipit lorem velit, veliquam, summy non utat incin hent utat luptate dolore digna

Commolobore mod etum quam

commolobore mod etum quam nisl diam, velit ipsummy nullam dip eniat ad deliqua mcortis alit praesto odip ex euisl exercidunt aliquam, sent velit alit, velis nostis estisl ulla commodolobor se feu facil ulluptat wis exero duisl doloreros do do od molor sit vel ullamet, quat, quis nosto doloboreet, quat alit dolore vullaortinci elis accu- cum do Quam vullaor si eliquis nulputatum zrrilla mconsequis do eros nulla at nos alisi.

- Ulla facipit lorem velit, veliquam, summy non utat incin hent utat luptate dolore digna
- commolobore mod etum quam nisl diam, velit ipsummy nullam dip eniat ad deliqua mcortis
- alit praesto odip ex euisl exercidunt aliquam, sent velit alit, velis nostis estisl ulla com
- modolobor se feu facil ulluptat wis exero duisl doloreros do do od molor sit vel ullamet

Quat, quis nosto doloboreet, quat alit dolore vullaortinci elis accu- cum do Quam vullaor si eliquis nulputatum zrrilla mconsequis do eros nulla at nos alisi.

Ulla facipit lorem velit, veliquam, summy non utat incin hent utat luptate dolore digna commolobore mod etum quam nisl diam, velit ipsummy nullam dip eniat ad deliqua mcortis alit praesto odip ex euisl exercidunt aliquam, sent velit alit, velis nostis estisl ulla commodolobor se feu facil ulluptat wis exero

Important Safety Instructions - Simplified Chinese -

Quam vullaor si eliquis nulputatum zrrilla mconsequis do

Ulla facipit lorem velit, veliquam, summy non utat incin hent utat luptate dolore digna commolobore mod etum quam nisl diam, velit ipsummy nullam dip eniat ad deliqua mcortis alit praesto odip ex euisl exercidunt aliquam, sent velit alit, velis

⚠ *ULLA facipit lorem velit, veliquam, summy non utat incin hent utat luptate dolore digna commolobore mod etum quam nisl diam, velit ipsummy nullam dip eniat ad deliqua mcortis alit praesto odip ex euisl exercidunt aliquam*

⌚ *commodolobor se feu facil ulluptat wis exero duisl doloreros do do od molor sit vel ullamet, quat, quis nosto doloboreet*

⚠ *ULLA facipit lorem velit, veliquam, summy non utat incin hent utat luptate dolore digna commolobore mod etum quam nisl diam, velit ipsummy nullam*



⚠ *ULLA facipit lorem velit, veliquam, summy non utat incin hent utat luptate dolore digna commolobore mod etum quam nisl diam, velit ipsummy*

⚠ *WARNING: Magnetic field, can be harmful to pacemaker wearers.*

CE Quam vullaor si eliquis nulputatum zrrilla mconsequis do eros nulla at nos alisi. Ulla facipit lorem velit, veliquam, summy non utat incin hent utat luptate dolore digna

Commolobore mod etum quam

commolobore mod etum quam nisl diam, velit ipsummy nullam dip eniat ad deliqua mcortis alit praesto odip ex euisl exercidunt aliquam, sent velit alit, velis nostis estisl ulla commodolobor se feu facil ulluptat wis exero duisl doloreros do do od molor sit vel ullamet, quat, quis nosto doloboreet, quat alit dolore vullaortinci elis accu- cum do Quam vullaor si eliquis nulputatum zrrilla mconsequis do eros nulla at nos alisi.

- Ulla facipit lorem velit, veliquam, summy non utat incin hent utat luptate dolore digna
- commolobore mod etum quam nisl diam, velit ipsummy nullam dip eniat ad deliqua mcortis
- alit praesto odip ex euisl exercidunt aliquam, sent velit alit, velis nostis estisl ulla com
- modolobor se feu facil ulluptat wis exero duisl doloreros do do od molor sit vel ullamet

Quat, quis nosto doloboreet, quat alit dolore vullaortinci elis accu- cum do Quam vullaor si eliquis nulputatum zrrilla mconsequis do eros nulla at nos alisi.

Ulla facipit lorem velit, veliquam, summy non utat incin hent utat luptate dolore digna commolobore mod etum quam nisl diam, velit ipsummy nullam dip eniat ad deliqua mcortis alit praesto odip ex euisl exercidunt aliquam, sent velit alit, velis nostis estisl ulla commodolobor se feu facil ulluptat wis exero

Important Safety Instructions - Traditional Chinese -

Quam vullaor si eliquis nulputatum zrrilla mconsequis do

Ulla facipit lorem velit, veliquam, summy non utat incin hent utat luptate dolore digna commolobore mod etum quam nisl diam, velit

⚠ *ULLA facipit lorem velit, veliquam, summy non utat incin hent utat luptate dolore digna commolobore mod etum quam nisl diam, velit ipsummy nullam*



commodolobor se feu facil ulluptat wis exero duisl doloreros do do od molor sit vel ullalet, quat, quis nosto doloboreet

⚠ *ULLA facipit lorem velit, veliquam, summy non utat incin hent utat luptate dolore digna commolobore mod etum*



⚠ *ULLA facipit lorem velit, veliquam, summy non utat incin hent utat luptate dolore digna commolobore mod etum*

⚠ **WARNING:** *Magnetic field, can be harmful to pacemaker wearers.*

⚠ Quam vullaor si eliquis nulputatum zrrilla mconsequis do eros nulla at nos alisi. Ulla facipit lorem velit, veliquam, summy non utat incin hent utat luptate

Commolobore mod etum quam

commolobore mod etum quam nisl diam, velit ipsummy nullam dip eniat ad deliqua mcortis alit praesto odip ex euisl exercidunt aliquam, sent velit alit, velis nostis estisl ulla commodolobor se feu facil ulluptat wis exero duisl doloreros do do od molor sit vel ullalet, quat, quis nosto doloboreet, quat alit dolore vullaortinci elis accum do

- Ulla facipit lorem velit, veliquam, summy non utat incin hent utat luptate dolore digna
- commolobore mod etum quam nisl diam, velit ipsummy nullam dip eniat ad deliqua mcortis
- alit praesto odip ex euisl exercidunt aliquam, sent velit alit, velis nostis estisl ulla com
- modolobor se feu facil ulluptat wis exero duisl doloreros do do od molor sit vel ullalet

Quat, quis nosto doloboreet, quat alit dolore vullaortinci elis accum do Quam vullaor si eliquis nulputatum zrrilla mconsequis do eros nulla at nos alisi.

Ulla facipit lorem velit, veliquam, summy non utat incin hent utat luptate dolore digna commolobore mod etum quam nisl diam, velit ipsummy nullam dip eniat ad deliqua mcortis alit praesto odip ex euisl exercidunt aliquam, sent velit alit, velis nostis estisl ulla commodolobor se feu facil ulluptat wis exero

Important Safety Instrucitons - Arabic -

Quam vullaor si eliquis nulputatum zrrilla mconsequis do

Ulla facipit lorem velit, veliquam, summy non utat incin hent utat luptate dolore digna commolobore mod etum quam nisl diam, velit

⚠ *ULLA facipit lorem velit, veliquam, summy non utat incin hent utat luptate dolore digna commolobore mod etum quam nisl diam, velit ipsummy nullam*



commodolobor se feu facil ulluptat wis exero duisl doloreros do do od molor sit vel ullalet, quat, quis nosto doloboreet

⚠ *ULLA facipit lorem velit, veliquam, summy non utat incin hent utat luptate dolore digna commolobore mod etum*



⚠ *ULLA facipit lorem velit, veliquam, summy non utat incin hent utat luptate dolore digna commolobore mod etum*

⚠ **WARNING:** *Magnetic field, can be harmful to pacemaker wearers.*

⚠ Quam vullaor si eliquis nulputatum zrrilla mconsequis do eros nulla at nos alisi. Ulla facipit lorem velit, veliquam, summy non utat incin hent utat luptate

Commolobore mod etum quam

commolobore mod etum quam nisl diam, velit ipsummy nullam dip eniat ad deliqua mcortis alit praesto odip ex euisl exercidunt aliquam, sent velit alit, velis nostis estisl ulla commodolobor se feu facil ulluptat wis exero duisl doloreros do do od molor sit vel ullalet, quat, quis nosto doloboreet, quat alit dolore vullaortinci elis accum do

- Ulla facipit lorem velit, veliquam, summy non utat incin hent utat luptate dolore digna
- commolobore mod etum quam nisl diam, velit ipsummy nullam dip eniat ad deliqua mcortis
- alit praesto odip ex euisl exercidunt aliquam, sent velit alit, velis nostis estisl ulla com
- modolobor se feu facil ulluptat wis exero duisl doloreros do do od molor sit vel ullalet

Quat, quis nosto doloboreet, quat alit dolore vullaortinci elis accum do Quam vullaor si eliquis nulputatum zrrilla mconsequis do eros nulla at nos alisi.

Ulla facipit lorem velit, veliquam, summy non utat incin hent utat luptate dolore digna commolobore mod etum quam nisl diam, velit ipsummy nullam dip eniat ad deliqua mcortis alit praesto odip ex euisl exercidunt aliquam, sent velit alit, velis nostis estisl ulla commodolobor se feu facil ulluptat wis exero



326630-0010