

BOSE[®]

Wave[®] Music System IV

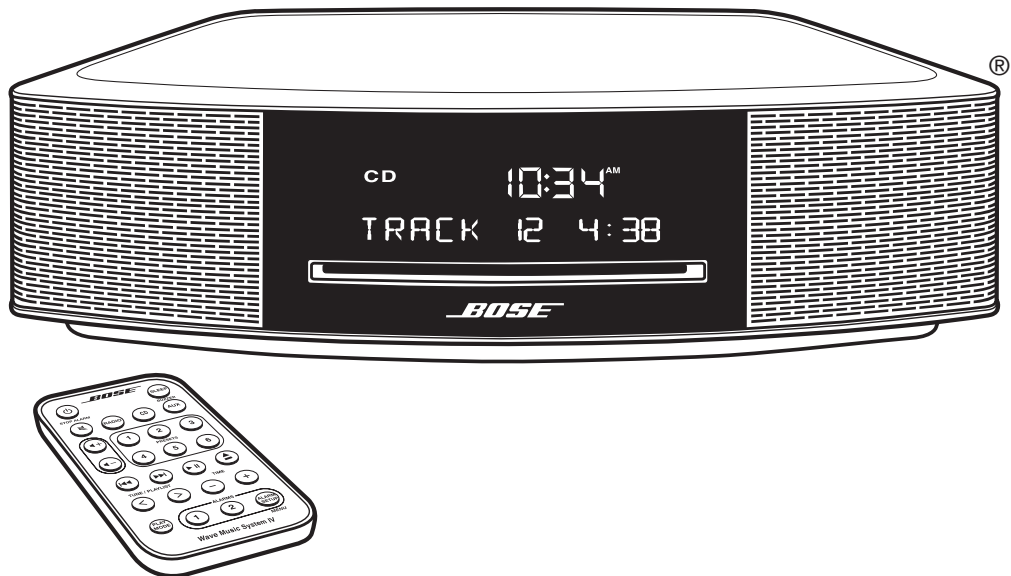

Important Safety Instructions

Please read this owner's guide carefully and save it for future reference.



The lightning flash with arrowhead symbol within an equilateral triangle alerts the user to the presence of uninsulated dangerous voltage within the system enclosure that may be of sufficient magnitude to constitute a risk of electrical shock.



The exclamation point within an equilateral triangle, as marked on the system, is intended to alert the user to the presence of important operating and maintenance instructions in this owner's guide.

WARNINGS:

- To reduce the risk of fire or electrical shock, do not expose the product to rain or moisture.
- Do not expose this apparatus to dripping or splashing, and do not place objects filled with liquids, such as vases, on or near the apparatus. As with any electronic products, use care not to spill liquids into any part of the system. Liquids can cause a failure and/or a fire hazard.
- Keep new and used batteries away from children. Do not ingest battery, chemical burn hazard. The remote control supplied with this product contains a coin/button cell battery. If the coin/button cell battery is swallowed it can cause severe internal burns in just 2 hours and can lead to death. If the battery compartment does not close securely, stop using the product and keep it away from children. If you think the battery may have been swallowed or placed inside any part of the body seek immediate medical attention. May explode or cause a fire or chemical burn if incorrectly replaced or mishandled. Do not recharge, disassemble, heat above 212°F (100°C), or incinerate. Replace only with an agency approved (ex. UL) CR2032 or DL2032 3-volt lithium battery. Dispose of used batteries promptly.
- Do not place any naked flame sources, such as lighted candles, on or near the apparatus.
- To prevent electric shock, match the wide blade of the line cord plug to the wide slot of the AC (mains) receptacle. Insert fully.



WARNING: This product contains magnetic material. Contact your physician if you have questions on whether this might affect the operation of your implantable medical device.



WARNING: Contains small parts which may be a choking hazard. Not suitable for children under age 3.

CAUTIONS:

- Make no modifications to the system or accessories. Unauthorized alterations may compromise safety, regulatory compliance, and system performance.
- Long-term exposure to loud music may cause hearing damage. It is best to avoid extreme volume when using headphones, especially for extended periods.
- Use of controls or adjustments or performance of procedures other than those specified herein may result in hazardous radiation exposure from the internal laser component. The compact disc player should not be adjusted or repaired by anyone except properly qualified service personnel.

Notes:

- The product label is located on the bottom of the product.
- The product must be used indoors. It is neither designed nor tested for use outdoors, in recreational vehicles, or on boats.
- Where the mains plug or appliance coupler is used as the disconnect device, such disconnect device shall remain readily operable.



廢電池請回收

Please dispose of used batteries properly, following any local regulations. Do not incinerate.

Class 1 laser product

This CD player is classified as a CLASS 1 LASER PRODUCT according to EN/IEC 60825. The CLASS 1 LASER PRODUCT label is located on the bottom of the unit.

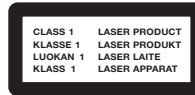

Important Safety Instructions

1. Read these instructions.
2. Keep these instructions.
3. Heed all warnings.
4. Follow all instructions.
5. Do not use this apparatus near water.
6. Clean only with a dry cloth.
7. Do not block any ventilation openings. Install in accordance with the manufacturer's instructions.
8. Do not install near any heat sources, such as radiators, heat registers, stoves or other apparatus (including amplifiers) that produce heat.
9. Protect the power cord from being walked on or pinched, particularly at plugs, convenience receptacles, and the point where they exit from the apparatus.
10. Only use attachments/accessories specified by the manufacturer.
11.  Use only with the cart, stand, tripod, bracket, or table specified by the manufacturer, or sold with the apparatus. When a cart is used, use caution when moving the cart/apparatus combination to avoid injury from tip-over.
12. Unplug this apparatus during lightning storms or when unused for long periods of time.
13. Refer all servicing to qualified service personnel. Servicing is required when the apparatus has been damaged in any way: such as power supply cord or plug is damaged; liquid has been spilled or objects have fallen into the apparatus; the apparatus has been exposed to rain or moisture, does not operate normally, or has been dropped.

NOTE: This equipment has been tested and found to comply with the limits for a Class B digital device, pursuant to Part 15 of the FCC rules. These limits are designed to provide reasonable protection against harmful interference in a residential installation. This equipment generates, uses, and can radiate radio frequency energy and, if not installed and used in accordance with the instructions, may cause harmful interference to radio communications. However, this is no guarantee that interference will not occur in a particular installation. If this equipment does cause harmful interference to radio or television reception, which can be determined by turning the equipment off and on, you are encouraged to try to correct the interference by one or more of the following measures:

- Reorient or relocate the receiving antenna.
- Increase the separation between the equipment and receiver.
- Connect the equipment to an outlet on a different circuit than the one to which the receiver is connected.
- Consult the dealer or an experienced radio/TV technician for help.

Changes or modifications not expressly approved by Bose Corporation could void the user's authority to operate this equipment.

This device complies with part 15 of the FCC Rules. Operation is subject to the condition that this device does not cause harmful interference.

This device complies with part 15 of the FCC Rules. Operation is subject to the following two conditions: (1) This device may not cause harmful interference, and (2) this device must accept any interference received, including interference that may cause undesired operation.

This Class B digital apparatus complies with Canadian ICES-003. CAN ICES-3(B)/NMB-3(B)

This device complies with FCC and Industry Canada RF radiation exposure limits set forth for general population. It must not be co-located or be operating in conjunction with any other antennas or transmitters.

This device complies with Industry Canada licence-exempt RSS standard(s). Operation is subject to the following two conditions: (1) This device may not cause interference, and (2) this device must accept any interference, including interference that may cause undesired operation of the device.

This equipment should be installed and operated with a minimum distance of 8 in. (20 cm) between this device and your body.

Product data logger

This system features a product data logger that is designed to help Bose better understand product usage and performance over time. The product data logger records certain technical data and usage history, including but not limited to volume levels, on/off data, user settings, source inputs, power output, and setup data. We may use this data to provide you with better service and support on your system and to improve product design in the future. Special equipment is required to read the data stored by the product data logger and such data can only be retrieved by Bose if your system is returned to Bose for service or as returned merchandise. The product data logger does not collect any personally identifiable information about you and does not record title, genre or other information about the media content you access while using your system.

Names and Contents of Toxic or Hazardous Substances or Elements						
Toxic or Hazardous Substances and Elements						
Part Name	Lead (Pb)	Mercury (Hg)	Cadmium (Cd)	Hexavalent (CR(VI))	Polybrominated Biphenyl (PBB)	Polybrominated diphenylether (PBDE)
PCBs	X	0	0	0	0	0
Metal parts	X	0	0	0	0	0
Plastic parts	0	0	0	0	0	0
Speakers	X	0	0	0	0	0
Cables	X	0	0	0	0	0

This table is prepared in accordance with the provisions of SJ/T 11364.
 O: Indicates that said hazardous substance contained in all of the homogeneous materials for this part is below the limit requirement of GB/T 26572.
 X: Indicates that said hazardous substance contained in at least one of the homogeneous materials used for this part is above the limit requirement of GB/T 26572.

Please complete and retain for your records

Record the serial number of your new Wave® Music System IV in the space below. The serial and model numbers can be found on the bottom panel.

Serial number: _____

Model number: _____

Purchase date: _____

We suggest you keep your receipt with this owner's guide.

Date of manufacture: The four bolded digits in the serial number indicate the date of manufacture. The first digit is the year of manufacture; "5" is 2005 or 2015. Digits 2-4 are the month and date; "001" is January 1 and "365" is December 31.

China Importer: Bose Electronics (Shanghai) Company Limited, Part C, Plan 9, No. 353 North Riyang Road, China (Shanghai) Pilot Free Trade Zone

EU Importer: Bose GP, Castleblayney Road, Carrickmacross, Ireland

Taiwan Importer: Bose Taiwan Branch, Room 905, 9F, Worldwide House, 131 Min Sheng East Rd, Section 3, Taipei, Taiwan, 105

The distinctive design of the Wave music system is a registered trademark of Bose Corporation in the U.S. and other countries.

©2015 Bose Corporation. No part of this work may be reproduced, modified, distributed or otherwise used without prior written permission.

Contents

Introduction

About your Wave® Music System IV	4
System Features.....	4
The demonstration CD.....	4
The benefits of research.....	4
Unpacking.....	4

Setting Up the System

Placing the system.....	5
Connecting to power.....	5
Setting the clock.....	5

Using the System

Remote control buttons.....	6
Touch pad.....	7
Reading the display.....	7
Powering on or off the system.....	7
Controlling the volume.....	7
Setting the Sleep timer.....	7

Listening to Other Sources

Listening to FM or AM radio.....	8
Tuning to an FM/AM station.....	8
Storing FM/AM radio station Presets.....	8
Improving FM reception.....	8
Playing audio CDs.....	8
Playing MP3 CDs.....	9
CD Play Modes.....	9

Setting and Using the Alarms

Alarm buttons and indicators.....	10
Using the Alarm buttons.....	10
Alarm status indicators.....	10
Setting the alarms.....	10
Using the alarms.....	10
Turning an alarm on or off.....	10
Snoozing an alarm.....	10

Connecting Other Equipment

System connections.....	11
Using the AUX IN connector.....	11
Using a cable to connect an audio device.....	11
Using headphones.....	12
Using an external antenna.....	12

Personalizing the System

The setup menu.....	13
Changing a system setting.....	13

Care and Maintenance

Troubleshooting.....	14
Replacing the remote control battery.....	15
Cleaning.....	15
Customer service.....	15
Limited warranty.....	15
Technical information.....	15

About your Wave® Music System IV

Your Wave® Music System IV provides an elegant way to bring high quality sound into any room.

System Features

- Display provides access to system settings and information.
- AUX connector enables playback from an audio device.
- Headphone connector for private listening.
- FM/AM tuner delivers precise radio reception.
- CD drive provides access to even more music.
- Remote control for point-and-click control from up to 20 feet away.

The demonstration CD

We encourage you to listen to the demonstration music CD included in the carton. Simply insert the demonstration disc and your Wave® Music System IV will play the CD automatically. For more details, see “Playing audio CDs” on page 9.

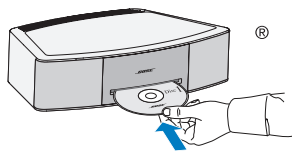

The benefits of research

Over fourteen years of research by Bose Corporation brings you the benefits of award-winning proprietary acoustic waveguide speaker technology. Using this technology, a tube efficiently transfers energy from a small speaker to the outside air over a wide range of low frequencies. And, long waveguides, folded into intricate patterns, fit into products small enough to be placed comfortably in your home. Your Wave® Music System IV features dual tapered waveguide speaker technology, connecting two speakers to two 26" tapered waveguides which combine to deliver performance well beyond the size of the system.

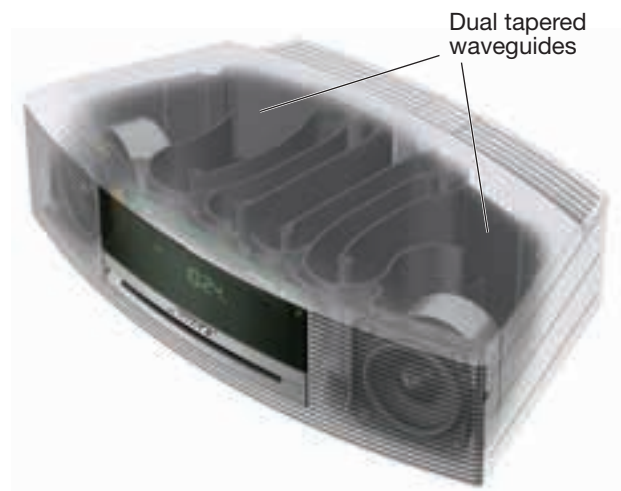

Unpacking

Carefully unpack the carton and confirm that the following parts are included.



Wave® music system IV



Remote control
(battery installed)



Demonstration CD



AC power cord(s)



3.5 mm stereo input cable

i May ship with multiple power cords. Use the power cord for your region.

Note: If part of the system is damaged, do not use it. Contact your authorized Bose® dealer or Bose customer service. Refer to the quick start guide in the carton for contact information.

Save the carton and packing materials for transporting or storing the system.

Setting Up the System

Placing the system

- To enjoy maximum audio performance:
 - Place the system across the room from where you listen.
 - Place the system within two feet of a wall, and avoid placing directly in a corner.
- Place the system on a flat, stable surface.

CAUTIONS:

- Do not place the system on a metal surface. It could interfere with AM reception.
- Do not place the system on a heat-sensitive surface. Like all electrical equipment, it generates some heat.
- Do not use the system in a damp location or any other place where moisture can get inside.

Connecting to power

1. Insert the small end of the power cord into the **AC POWER** connector.
2. Plug the power cord into an AC (mains) power outlet.

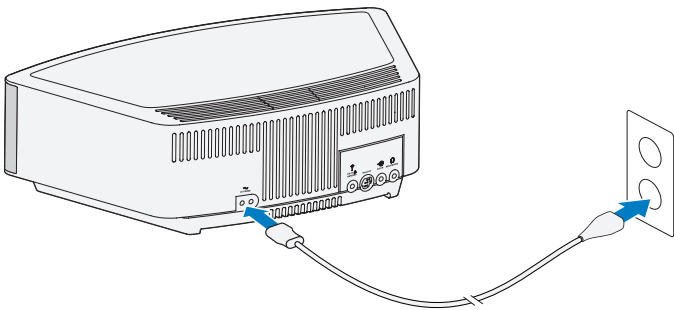

Setting the clock

After plugging in the system, set the clock using the remote.

1. Press and hold either **Time -** or **Time +** for about one second.

Note: Press-and-hold operations require holding the button down for about one second.

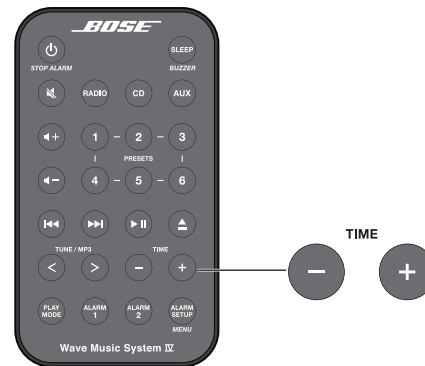

Initially, **HOLD TO SET** appears on the display and then quickly changes to **- CLOCK SET -** as the button is depressed.

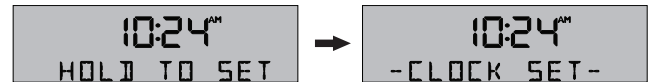

2. Release the selected **Time** button.
3. Press **Time -** to adjust the displayed time backward or press **Time +** to adjust the displayed time forward until it matches the current time. You can also press and hold for rapid adjustment.
4. Wait five seconds for the system to exit clock setup mode.

Notes:

- To change the clock from 12-hour (AM/PM) time to 24-hour time, see "Changing a system setting" on page 13.
- If the system loses power due to a power outage or if you unplug the system, all system settings are permanently retained. However, the clock time is only temporarily stored in backup memory for up to 48 hours.

Remote control buttons

Use the remote control to operate the system. Aim the remote at the display and press the buttons. The remote works within 20 feet of the display.



Using the System

Touch pad

The system has a touch-sensitive control pad on the top panel.

Momentarily placing your hand on the touch pad can power on or off the system, snooze a sounding alarm, and reset it for the next day (see page 11).

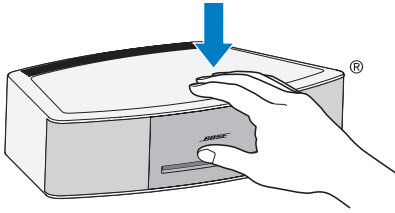

Notes:

- Press-and-hold operations require holding the button down for about one second.
- Pressing **RADIO**, **CD**, or **AUX** automatically powers on the system to the selected source.

Reading the display

Source indicators: CD, FM, AM, or AUX

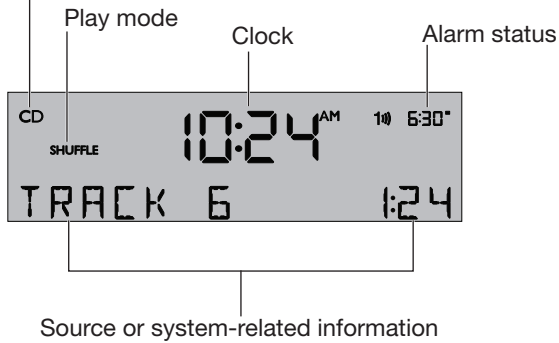

Powering on or off the system

- Press  on the remote control

or

- Touch the touch pad.

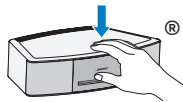

The last source you were listening to is active.

Alternatively:

Press any source button to power the system on to that source.





Notes:

- Selecting **AUX** does not power on a device connected to AUX IN (such as a media player). Power on the device first.
- After 24 hours of no button presses, the system switches to standby (off). If the 20-minute system standby timer (page 14) is enabled, the system switches to standby if no audio is played and no buttons are pressed for 20 minutes.

Controlling the volume



Press and hold  + or  - to adjust the volume level.

VOLUME - 0 (silent) to **99** (loud) appears on the display to indicate the level.



Press to mute the system.

Press again, or press  + to unmute.

While muted, you can press  - to lower the volume before unmuting the system.

Note: When the system is off, the volume can only be adjusted between 10 and 75.

Setting the Sleep timer



Press **SLEEP** to set the system to shut off after a selected period of time.

- After pressing **SLEEP**, **SLEEP - 30 MIN** (or your last setting) appears on the display and the sleep timer begins counting down. If the system is off, press **SLEEP** to power on and immediately set the sleep time. The last source selected will start playing as the sleep timer counts down.
- While the **SLEEP** setting is displayed, press **SLEEP** again to set the sleep timer to 10-90 minutes (in 10-minute increments) or OFF.

Note: If more than 10 seconds elapses between button presses, the system automatically exits the sleep timer setup mode.

- To review the remaining sleep time, press **SLEEP**.
- To cancel the sleep timer, press and release **SLEEP** until **SLEEP - OFF** appears on the display.

Listening to FM or AM radio

RADIO Press **RADIO** to turn it on to the station last selected. Press **RADIO** as necessary to select FM or AM radio.

When you select FM radio, Radio Data System (RDS) information for the current station is displayed. This is controlled by the **RADIO TEXT** setting in the setup menu. To disable RDS and view only the station frequency, change the **RADIO TEXT** setting to OFF. See "Changing a system setting" on page 14.



Tuning to an FM/AM station

When you press **RADIO**, **Seek/Track**, or **Tune/MP3** to tune to a radio station, the frequency appears in the center of the display while you are tuning.



- Press **Seek/Track** **◀** to find a lower-frequency station with a strong signal.
- Press **Seek/Track** **▶** to find a higher-frequency station with a strong signal.



- Press **Tune/MP3** **<** to manually tune to a lower frequency.
- Press **Tune/MP3** **>** to manually tune to a higher frequency.
- Press and hold **Tune/MP3** **<** or **Tune/MP3** **>** to rapidly change the frequency.

Note: If AM reception is weak, rotate the system clockwise or counterclockwise to improve AM reception. If FM reception is weak, make sure the power cord is straightened as much as possible. To improve FM reception, you can install an external FM antenna (see page 13).

Storing FM/AM radio station Presets

You can store up to six FM and six AM radio stations for quick recall using the **Presets** buttons. Storing a preset replaces any station previously stored to that preset number.



1. Tune to the station you want to save as a preset.
2. Press and hold one of the six **PRESETS** buttons until you hear a double tone and the preset number and station frequency appear on the display.
3. Press one of the **PRESETS** buttons to quickly tune to a previously stored FM or AM station.

Improving FM reception

Unwind and straighten the power cord to ensure the best FM radio reception. The power cord is used as an antenna.

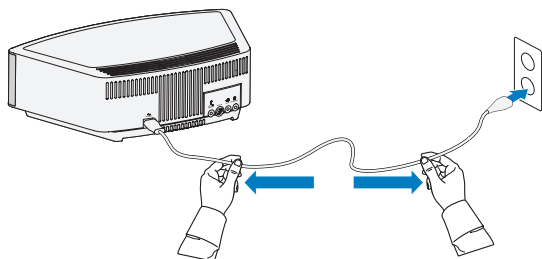

Playing audio CDs

Insert the disc, label side up, into the CD slot below the display. The disc player pulls the disc in and begins playing.

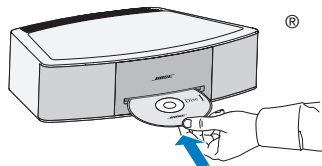

Press **CD** if the CD source is not selected.

- When playing an audio CD, source information is displayed:

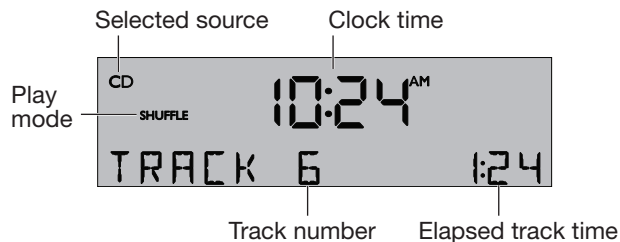

- Press **Play/Pause** to pause a playing CD. The elapsed time flashes while paused. Press **Play/Pause** again to resume play.



- Press **Seek/Track** **◀** to skip to the beginning of the current track; Press **Seek/Track** **◀** again to skip to the beginning of the previous track.
- Press **Seek/Track** **▶** to skip to the next track.



- Press and hold **Tune/MP3** **<** to scan backward quickly through a track; press **Tune/MP3** **>** to scan forward quickly through a track.



- Press **Stop/Eject** to stop a CD. Press **Stop/Eject** again to eject a CD. If a CD is playing, press and hold **Stop/Eject** to stop a CD and eject it.

Notes:

- When you play a stopped CD it will always resume from the place it was stopped.
- If you eject a CD but do not remove it from the CD player slot within 10 seconds, the CD player will pull the CD back into the player and reload it.

CAUTION: DO NOT INSERT mini CDs or non-circular CDs into the disc player. These discs may not play properly and could interfere with the system's ability to eject them.

Listening to Other Sources

Playing MP3 CDs

The system can play MP3 music files recorded on CD-R and CD-RW discs. To play, pause, stop or eject an MP3 CD, use the same remote control buttons as for an audio CD.

You can easily navigate through your music files using the **Tune/MP3** and **Seek/Track** remote control buttons.

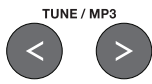

- Press **Tune/MP3** < to skip to the previous folder.
- Press **Tune/MP3** > to skip to the next folder.



- Press **Seek/Track** ◀◀ to skip to the beginning of the current track.
- Press **Seek/Track** ◀◀ again to skip to the beginning of the previous track.
- Press **Seek/Track** ▶▶ to skip to the next track.

When navigating an MP3 CD, folder number and track number are displayed:

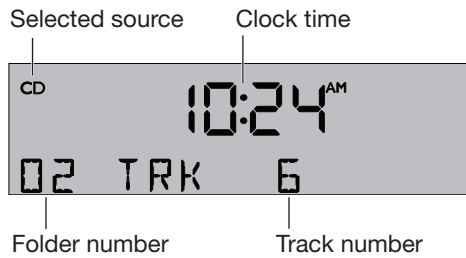

Note: The Root level is displayed as folder number 00.

Once the track begins playing, artist name, song title, and elapsed track time will return to the display:

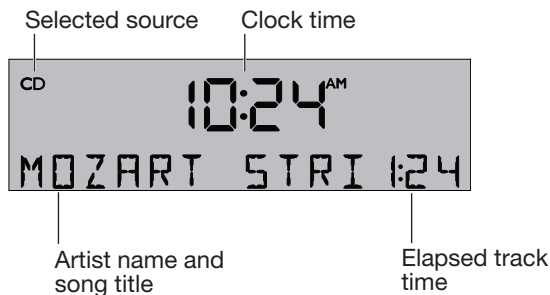

Notes:

- The system will display artist name and song title information when available on music file CDs.
- The audio quality of MP3 CDs is dependent on factors such as the encoded bit rate, the sampling rate, and the type of encoder used. The system supports MP3 CDs encoded at bit rates of 64kbps or higher, and sampling rates of 32kHz or higher. It is recommended that a bit rate of at least 128kbps and a sampling rate of 44.1kHz or better be used.
- Playback quality of recorded CD-R and CD-RW discs is dependent on the CD recording process and software used to record the disc. An improperly recorded audio CD may cause the system to exhibit unexpected behavior.

CD Play Modes



While a CD is playing, you can change the way it is played. Press **Play Mode** repeatedly until the play mode you want is displayed:

Mode	CD	MP3	Description
NORMAL PLAY	✓	✓	Plays tracks once in sequential order.
SHUFFLE DISC	✓	✓	Plays all tracks once in random order.
SHUFFLE RPT	✓		Repeats all tracks in a random order that changes each time the disc is repeated.
REPEAT DISC	✓	✓	Repeats the disc from the beginning after the last track is played.
REPEAT TRACK	✓	✓	Repeats the selected track continuously.
SHUFFLE FLDR		✓	Plays all tracks in the selected folder in random order (MP3 only).
SHUF RPT FDR		✓	Repeats all tracks in the selected folder in random order (MP3 only) that changes each time the folder is repeated.
SHUFF RPT CD		✓	Repeats all tracks on a disc in a random order that changes each time the disc is repeated.
REPEAT FOLDR		✓	Repeats all tracks in a folder in order (MP3 only).

Note: The play mode will return to NORMAL PLAY whenever a CD is inserted.

Alarm buttons and indicators

The system has two alarms, **Alarm 1** and **Alarm 2**.

Each alarm can be set for:

- Time
- Volume
- Wake-up source: buzzer, radio, or CD

Using the Alarm buttons

Using the Alarm buttons on the bottom of the remote you can setup and operate each alarm:

Press to turn Alarm 1 on or off.

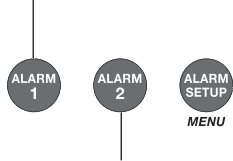

1. Press to activate the Alarm Setup mode and view Alarm 1 settings.
2. Press again to view Alarm 2 settings.
3. Press again to exit the Alarm Setup mode.

Press to turn Alarm 2 on or off.

Alarm status indicators

The upper right-hand corner of the display shows the alarm status indicators if the alarm is set.

Example with Alarm 1 and 2 set:

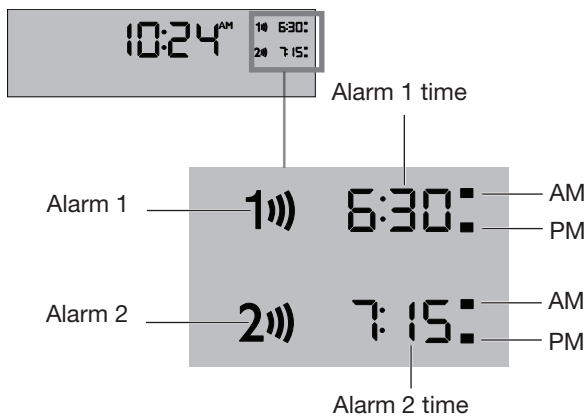

Setting the alarms

You can choose the settings for each alarm by activating the Alarm Setup mode and displaying the settings for each alarm.

To setup Alarm 1 or 2:



1. Press **Alarm Setup** .

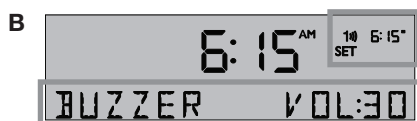
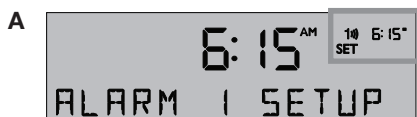

The alarm number and time start flashing (A) and after a moment, the current Alarm 1 settings are displayed (B).



2.  Using the Time buttons, set the alarm time.

3. Select your wake-up source:

- **BUZZER**  is the factory alarm setting.
- Press **RADIO**  to choose a radio station.
- Press **CD**  to choose a track.

4.  Press  or  to set the volume level of the selected wake-up source.

5. Press **ALARM SETUP**  to enter the Alarm 2 setup mode.
Repeat Steps 2-4 to set up Alarm 2.

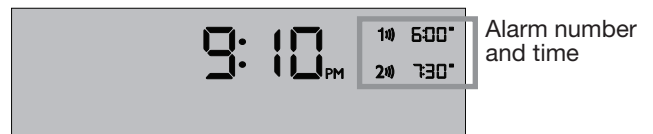

6. Press **ALARM SETUP**  again to exit the Alarm Setup mode.

The alarm you set is turned on and the alarm time displays:



Using the alarms

Turning an alarm on or off

Press **ALARM 1**  or **ALARM 2**  to turn the selected alarm on or off.

When an alarm is turned on, the alarm number and time appear in the upper right corner of the display.

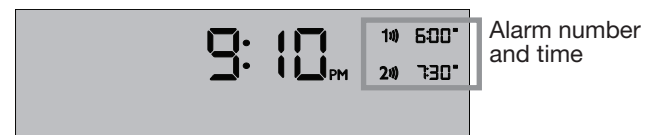

Snoozing an alarm

Tap the touch pad  or press **SLEEP**  on the remote.

SNOOZE is displayed for the duration of the selected snooze time and then the alarm sounds again.

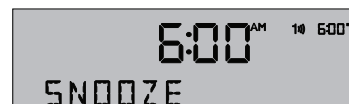

The snooze time is set at the factory to 10 minutes. To change the snooze time, see page 14.

Stop and reset a sounding alarm

Press **STOP ALARM** .

Reset a snoozed alarm for the next day

After snoozing the alarm, place your hand on the touch pad again and hold it there for at least 2 seconds, or press **Stop Alarm**.

Connecting Other Equipment

System connections

The rear panel of the system provides connections for external equipment.

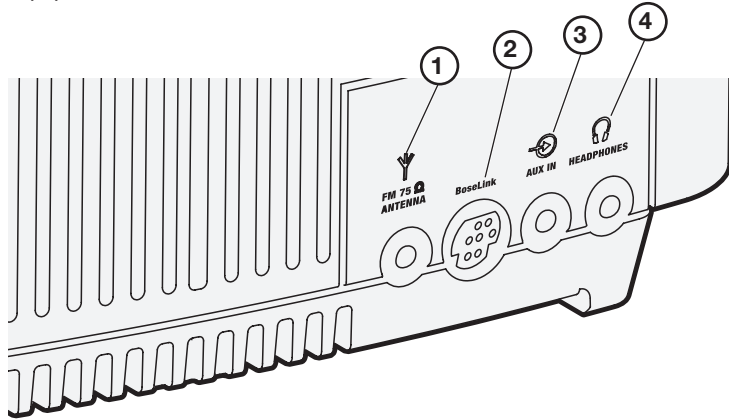

- 1 ANTENNAS**
3.5 mm FM antenna (75 ohm) connector. See “Using an external antenna” on page 13.
- 2 Bose link**
An input that accepts the output of another Bose link enabled product via a Bose link cable.
- 3 AUX IN**
3.5 mm stereo input connector for external sources.
- 4 HEADPHONES**
A 3.5 mm stereo headphone connector.

Using the AUX IN connector

When using a TV, DVD player, computer, video game or other audio source, you can enhance your listening experience by playing the audio device through the system.

Connecting an audio device to the system requires one of the following cables:



3.5 mm audio cable







3.5 mm to stereo RCA cable

To obtain the correct cable, contact Bose® customer service or visit a local electronics store. Refer to the quick start guide in the carton.

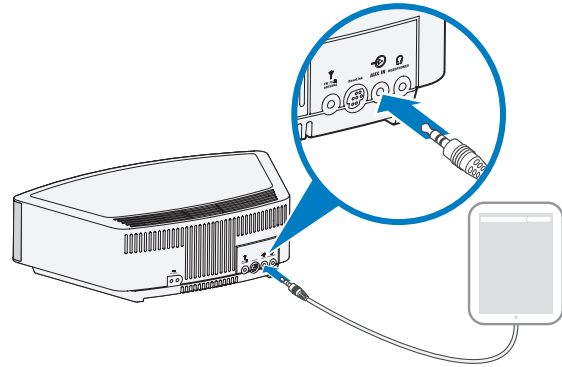
Using a cable to connect an audio device

1. Using a cable, connect your audio device to the **AUX IN** connector on the system’s connector panel.



2. Press  on the remote control.
The last source you were listening to is active.
3. Press and release  until **AUX** appears on the display.
4. Start playing music on the audio device.
5. Press and hold  or  to adjust the volume.

Note: If the volume level of the system cannot be adjusted high enough, increase the volume level of the connected audio device.

Using headphones

For private listening, plug the headphones into the headphone connector on the rear panel of the system.

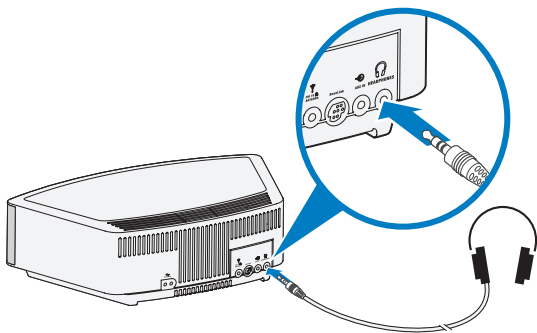

CAUTION: Long-term exposure to loud music may cause hearing damage. It is best to avoid extreme volume when using headphones, especially for extended periods.

Notes:

- Plugging in headphones automatically mutes the speakers. Because headphone volume levels may vary from speaker volume levels, be sure to lower the volume of the system before connecting or disconnecting headphones.
- While using headphones, alarms will be heard through the system speakers.

Controlling the headphones volume:

Press and hold **+** or **-** to adjust the listening level of your headphones.

Using an external antenna

The system power cord is used as an antenna for FM radio. If, after adjusting the position of the power cord, you still experience poor reception, you may need to install an external antenna. An external dipole antenna can be ordered through Bose Customer Service. Refer to the quick start guide in the carton.

1. Insert the 3.5 mm plug of the FM antenna into the **FM ANTENNA** connector.
2. Extend the ends of the antenna as far from the unit and other external equipment as possible to establish optimum reception.

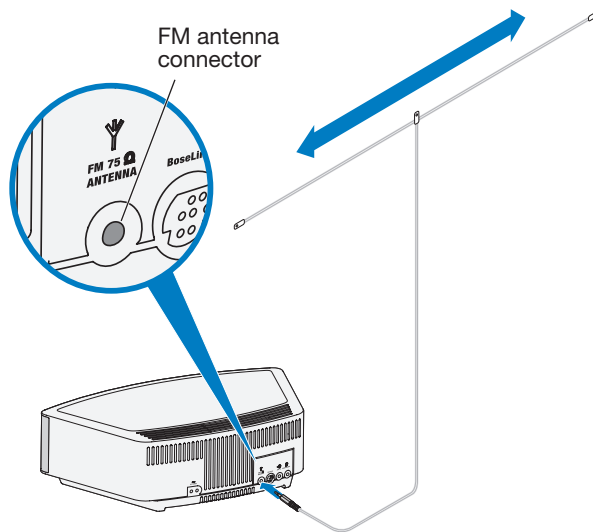

Note: Many FM radio stations transmit a vertically polarized signal as well as, or instead of, a horizontally polarized signal. If the horizontal antenna orientation does not provide good reception, try hanging the antenna in a vertical orientation.

Personalizing the System

The setup menu

The setup menu allows you to customize the operation of the system.

System Setting	Menu Item	Factory Setting	Choices	Description
Snooze duration	SNOOZE-	10 MIN	10 MIN, 20 MIN, 30 MIN, 40 MIN, 50 MIN, 60 MIN	This setting determines the duration of time the system remains silent when the snooze function is activated.
Radio Data System (RDS) information	RADIO TEXT-	ON	ON, OFF	Enables (ON) or disables (OFF) the system to display RDS information.
Continuous play	CONT PLAY-	NO	NO, AUX, FM, AM, DAB	Determines which source will automatically play after a CD ends.
Bass level	BASS-	NORMAL	NORMAL, REDUCED	Adjusts the bass level.
Clock time format	TIME-	12 HOUR	12-HOUR, 24-HOUR	Sets the clock display for 12-hour (AM/PM) or 24-hour time.
Display high brightness level	BRIGHT HI-	10	8-15	Sets the display brightness level when the unit detects high ambient light conditions.
Display low brightness level	BRIGHT LO-	4	1-8	Sets the display brightness level when the unit detects low ambient light conditions.
Room code	ROOM-	B _ _ _ -	B _ _ _ -, C _ _ _ -, D _ _ _ -, E _ _ _ -, F _ _ _ -, G _ _ _ -, H _ _ _ -, I _ _ _ -, J _ _ _ -, K _ _ _ -, L _ _ _ -, M _ _ _ -, N _ _ _ -, O _ _ _ -	Sets the room code for the system when it is connected to a Bose link network. The dashes following the room letter indicate how the microswitches should be set on a Lifestyle® remote control.
Capacitive touch control	TOUCH PAD-	ON	ON, OFF	Enables (ON) or disables (OFF) the touch pad.
20-minute system standby timer	AUTO OFF-	YES	YES, NO	Enables (YES) or disables (NO) the 20-minute system standby timer. See “Powering on or off the system” on page 8.
System reset	RESET ALL-	NO	NO, YES	Restores the system to factory settings.

Changing a system setting



1. Press and hold **Alarm Setup/Menu** until **-SETUP MENU-** is displayed.

TUNE / MP3



2. Press **Tune/MP3** to skip to the menu item you want.

TIME



3. Press **Time +** or **Time -** to change the setting.



4. Press **Alarm Setup/Menu** to exit the setup menu or wait 10 seconds for the setup menu to exit automatically.

Troubleshooting

Problem	What to do
System does not function	<ul style="list-style-type: none"> • Connect the system to AC (mains) power. • Unplug the power cord from the AC wall outlet for 10 seconds and then reconnect it; this resets the system. • Tap the touch pad on the top of the system (see page 8).
No sound	<ul style="list-style-type: none"> • Increase the volume. • Eject and reload the CD. • Disconnect headphones from the system (connecting headphones mutes the speakers).
Poor sound quality	<ul style="list-style-type: none"> • If the bass is too heavy or low, adjust the bass level of the system using the setup menu (see page 14) • If listening to an external AUX source, use a stereo cable and make sure it is fully inserted.
Remote control is inconsistent or does not work	<ul style="list-style-type: none"> • Operate the remote control closer to the system. • Check that the remote control battery is installed with positive (+) polarity facing up. • Replace the remote control battery. • Check for interference from fluorescent room lighting, sunlight, or dust or dirt on lens. • Try the system in a different location.
AM reception is weak	<ul style="list-style-type: none"> • Turn the system slightly one way and then the other to change the direction of the internal AM antenna. • Move the unit farther from a TV, refrigerator, halogen lamps, dimmer switches, or other electronic equipment that generates electrical noise. • If neither suggestion works, you may be in an area of weak AM signal coverage.
FM reception is weak	<ul style="list-style-type: none"> • Extend the power cord as much as possible. The power cord acts as an FM antenna (see page 9). • See “Using an external antenna” on page 13.
CD does not play	<ul style="list-style-type: none"> • Select the CD source or press . The CD icon appears on the display. • Load the CD label-side up. • Check that the disc surface is clean, If not, try cleaning it. • Try another disc.

Care and Maintenance

Replacing the remote control battery

Place the remote face down on a flat surface.

1. Using your finger, push the tab lock to the side as shown and hold. Slide the battery compartment open.

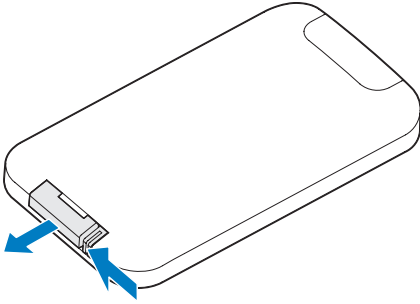

2. Remove the old battery and install the new one with the plus (+) symbol facing up.

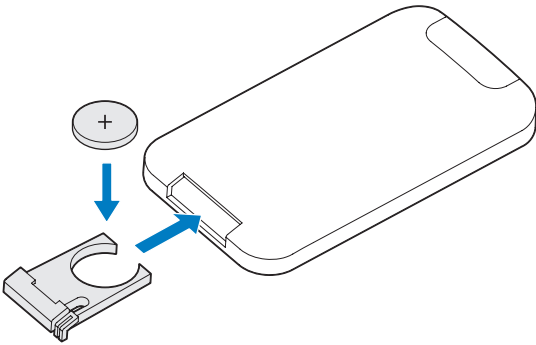

3. Gently slide the battery compartment closed. It locks automatically.

WARNING: Keep new and used batteries away from children.

Do not ingest battery, chemical burn hazard. The remote control supplied with this product contains a coin/button cell battery. If the coin/button cell battery is swallowed it can cause severe internal burns in just two hours and can lead to death. If the battery compartment does not close securely, stop using the product and keep it away from children. If you think the battery may have been swallowed or placed inside any part of the body, seek immediate medical attention. The coin/button cell battery may explode or cause a fire or chemical burn if incorrectly replaced or mishandled. Do not recharge, disassemble, heat above 212°F (100°C), or incinerate. Replace only with an agency approved (ex. UL) CR2032 or DL2032 3-volt lithium battery. Dispose of used batteries promptly.

Cleaning

Clean the surface of the system with a soft, dry cloth.

- Do not use any sprays near the system. Do not use any solvents, chemicals, or cleaning solutions containing alcohol, ammonia or abrasives.
- Do not allow liquids to spill into any openings.

Customer service

For additional help, contact Bose Customer Service. Refer to the quick start guide in the carton.

Limited warranty

Your system is covered by a limited warranty. Details of the limited warranty are provided on the quick start guide in the carton.

Please refer to the quick start guide for instructions on how to register. Failure to register will not affect your limited warranty rights.

The warranty information provided with this product does not apply in Australia and New Zealand. See our website at www.bose.com.au/warranty or www.bose.co.nz/warranty for details of the Australia and New Zealand warranty.

Technical information

AC power rating

220V-240V ~ 50/60Hz 60W max.





745089-0010

BOSE[®]
Better sound through research[®]

©2015 Bose Corporation, The Mountain,
Framingham, MA 01701-9168 USA
AM745089 Rev. 00