



FreeSpace® E4 Series II System Electronics

PROFESSIONAL SYSTEMS DIVISION

Product Overview

The Bose® FreeSpace® E4 Series II system is an integrated four-zone system providing signal processing, routing and amplification for business music applications.

System setup and configuration are accomplished using the included FreeSpace Installer™ software.

Bose Standard or Auto Volume or Paging interfaces allow the system owner to control system operation.

Product Information

As a single component, the FreeSpace E4 Series II system provides all of the necessary processing and control functions for most business music applications requiring one to four zones with up to 400W of system power.

Signal processing and routing for up to four sources, three audio and a page source, is accomplished using digital signal processing. Each source may be assigned to one of four output zones.

Each zone output supports Auto Volume, Dynamic Equalization, Room EQ, Speaker EQ and Output Gain functions.

A proprietary Power Sharing amplifier distributes up to 400W of system power across the four output zones. Each output zone may draw as little as 1W of power, to as much as 400W. The amount of power delivered to an output zone is dependent on the quantity and tap of loudspeakers that are connected. The amplifier can be configured for either 70V or 100V constant voltage systems.

FreeSpace Installer software is included with the FreeSpace E4 Series II system. Used for the setup and configuration of the system, the FreeSpace Installer software requires a PC for operation.



Key Features

- Proprietary Power Sharing amplifier dynamically distributes 400W of system power across the four output zones.
- Auto Volume offers automatic control of individual zone volume. Volume levels are adjusted to compensate for changes in background noise according to the desired settings.
- Each output zone may be independently paged.
- Opti-voice® paging provides a smooth transition between the music and page signals.
- Opti-source® level management monitors the input level of up to four sources. Source levels are continually adjusted to maintain a consistent volume level among different sources.
- Scheduling allows system ON/OFF, zone volume, mute, Auto Volume and source change events to be programmed. Up to 64 events may be programmed to occur on specific days and times.

Applications

The FreeSpace E4 Series II system is ideal for business music applications requiring up to four system zones such as:

- Restaurants
- Supermarkets
- Conference centers
- Shopping centers



Product Specifications

Performance

Amplifier Power¹

EIA (1 kHz, 1% THD): 440W
 FTC Continuous Average: 400W

THD (@ full-rated power)

<1.0%

Crosstalk (below rated power, 1 kHz)

>70 dB

Common Mode Rejection (20 Hz to 1 kHz)

50 dB

Signal-To-Noise Ratio (below rated power, A-weighted)²

90 dB

A/D, D/A Converters

24 bit, 128x oversampling

Frequency Response (@ 1 watt)

20 Hz-20 kHz, +/- 1 dB

Sample Rate

44.1 kHz

AC Power Consumption

Idle: 60W
 Active: 300W maximum with program material

Environmental

Temperature: 32-122°F/0-50°C
 Humidity: 85% relative humidity

Mechanical Specifications

Dimensions

17.25"W x 15.5"D x 5.25"H
 (438.3 mm x 398.7 mm x 133.4 mm)

Weight

30 lb (13.6 kg)

Front View

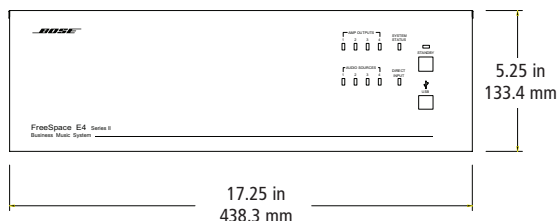

Side View

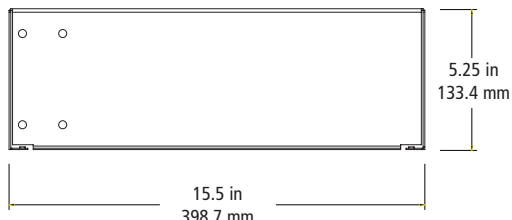

Audio Inputs

Line Inputs (2 – Unbalanced)

Connector: Dual RCA (summed to mono)
 Range: -30 dBV to +17 dBV
 Impedance: 25k ohms
 Max Level: +17 dBV

Mic/Line Input (1 – Balanced)

Connector: 3-pin Euroblock
 Range: -60 dBV to +17 dBV
 Impedance: 3.3k ohms
 Max Level: +17 dBV

Mic/Line/Page Input (1 – Balanced)

Connector: 4-pin Euroblock
 Range: -60 dBV to +17 dBV
 Impedance: 3.3k ohms
 Max Level: +17 dBV

Direct Input (1 – Balanced)

Connector: 4-pin Euroblock
 Range: 0 dBV
 Impedance: 2.5k ohms
 Max Level: 0 dBV

Auto Volume Sense Mics (4 – Unbalanced)

Connector: 2-pin Euroblock

Audio Outputs

Amplifier Outputs (4)

Connector: 2-pin inverted Euroblock
 Min load: 12.5 ohms @ 70V, 25 ohms @ 100V

Line Output (1 – Balanced)

Connector: 4-pin Euroblock
 Impedance: 200 ohms
 Max Level: +11 dBV (70V), +14 dBV (100V)

Music On Hold Output (1 – Unbalanced)

Connector: 2-pin Euroblock
 Impedance: 400 ohms
 Max Level: +15 dBV

Detailed Product Specifications

Front- and Rear-Panel Controls and Indicators

- 1 **Input Signal Level Indicators** for each of the four inputs. Each LED indicates:
 - YELLOW – Low Input Signal Level
> -13 dBV, signal, < -2 dBV
 - GREEN – Good Input Signal Level
> -2 dBV, signal, < +14 dBV
 - RED – Input Signal Clipping
signal > +14 dBV
- 2 **Output Status Indicators** display the output status for each of the four output zones. Each LED indicates:
 - GREEN – Good Input Signal Level, zone operating normally
 - RED – Input Signal Clipping or Amplifier Fault
- 3 **System Status Indicator** displays the current state of the system:
 - OFF – System is not operating
 - GREEN – System is operating normally
 - RED – System fault
- 4 **Standby Indicator** displays the operating state of the system:
 - OFF – System is operating
 - YELLOW – System is in standby
- 5 **Standby Button** is used to place the system into and out of standby.
- 6 **USB** for future connection.
- 7 **Direct Input Indicator** displays the current state of the Direct Input:
 - OFF – Direct Input is not active
 - YELLOW – Direct Input is active
- 8 **RS-232** is used for the connection to the PC for setup and configuration with the FreeSpace® Installer™ software.
- 9 **AC Mains Power** is used to turn the AC Mains power ON and OFF.

Front

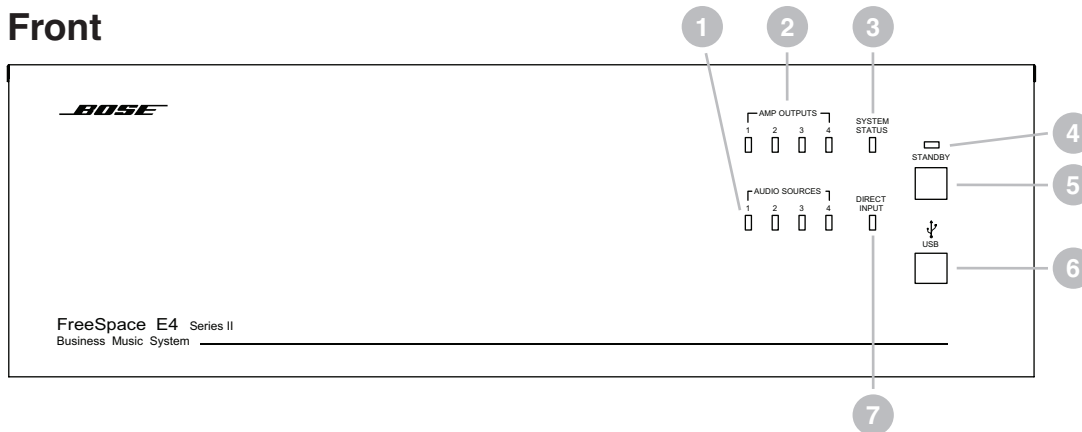

Rear

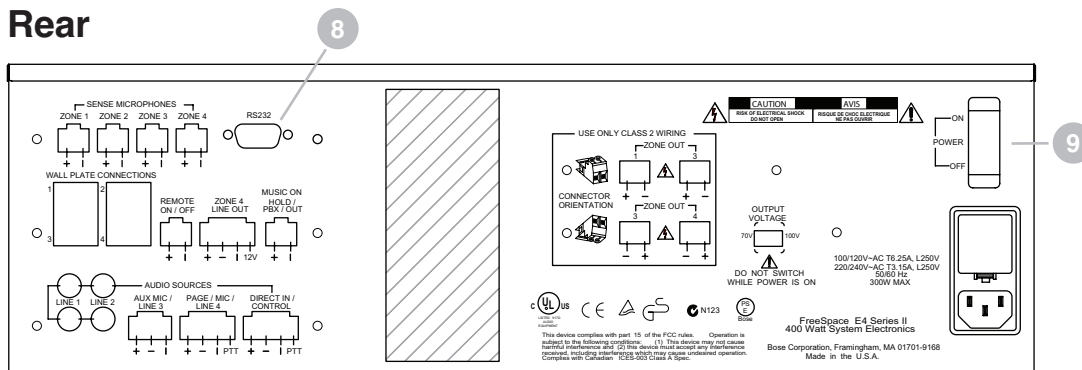

FreeSpace® E4-II System Accessories

The following accessories are available for the FreeSpace E4 Series II System.



Standard User Interface provides control of sources, volume and mute for a single zone.

Standard UI, North America/Japan PC029856
Standard UI, Europe/Australia PC029857



Multi-Zone Paging Interface provides selection of individual zone, all page and page initiation.

Page UI, North America/Japan PC030103
Page UI, Europe/Australia PC030104



Auto Volume User Interface provides control of sources, volume and Auto Volume operation for a single zone.

Auto Volume UI, North America/Japan PC030101
Auto Volume UI, Europe/Australia PC030102



Auto Volume Sense Microphone, placed within a system zone to measure background noise.

Auto Volume Sense Mic, North America/Japan PC029859
Auto Volume Sense Mic, Europe/Australia PC029860



Rack-mount ears used for mounting the E4 system within a standard 19-inch equipment rack.

FreeSpace E4-II Rack Ears PC029858

Figure 1: Two-Zone System

Example System: Small Market

The store is comprised of two zones, the main retail area and the cashier area. The main retail area receives music and paging, and operates at a fixed volume level.

The cashier area also receives music and paging, but its volume is controlled by the Auto Volume function and an Auto Volume wall plate.

		Zone 1 Retail	Zone 2 Cashier	Zone 3	Zone 4
Sources	Music	•	•		
	Paging	•	•		
Controls	Standard Wallplate	•			
	Auto Volume Wallplate		•		

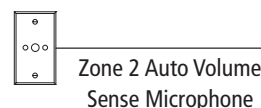
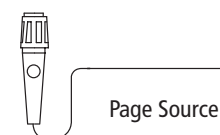
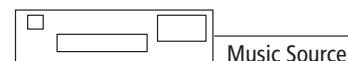

Figure 2: Four-Zone System

Example System: Restaurant

The restaurant is comprised of four zones: dining, bar, patio, and the restrooms and lobby. All zones receive the music source, and the bar and lobby area receive paging. The bar area also can select the television audio source.

The dining and bar areas' volume is controlled by the Auto Volume function. The remaining zones, the patio and restrooms/lobby, are controlled using standard wall plate controls. A multi-zone paging interface is connected to the wall plate number four connection to provide independent paging of the two page zones.

		Zone 1 Dining	Zone 2 Bar	Zone 3 Patio	Zone 4 Entry/Restrooms
Sources	Music	•	•	•	•
	TV		•		
	Paging		•		•
Controls	Standard Wallplate			•	•
	Auto Volume Wallplate	•	•		

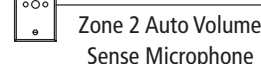
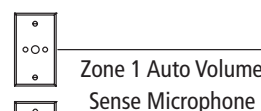
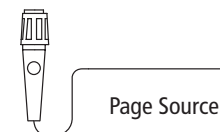
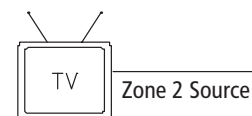
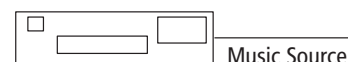

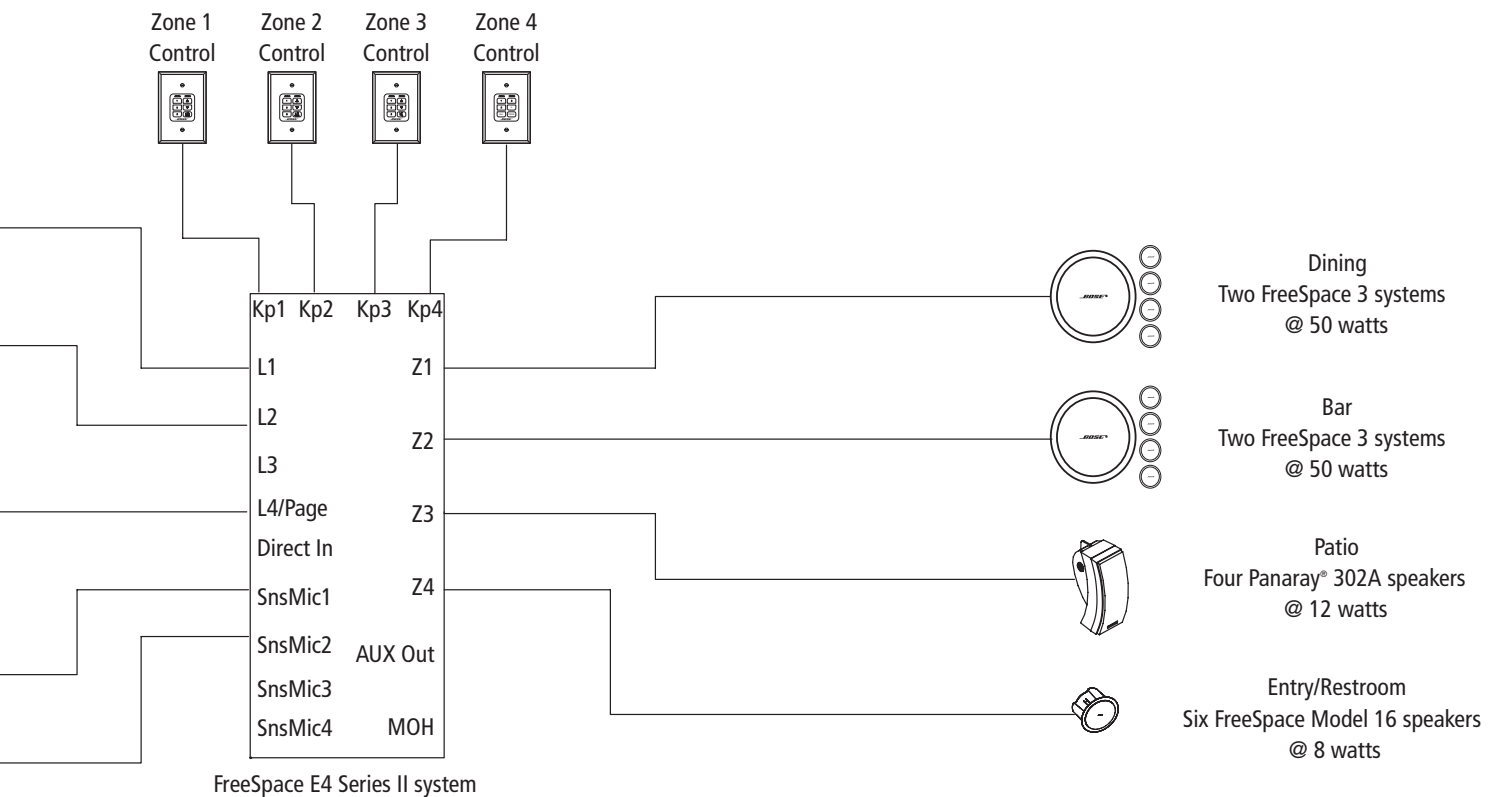
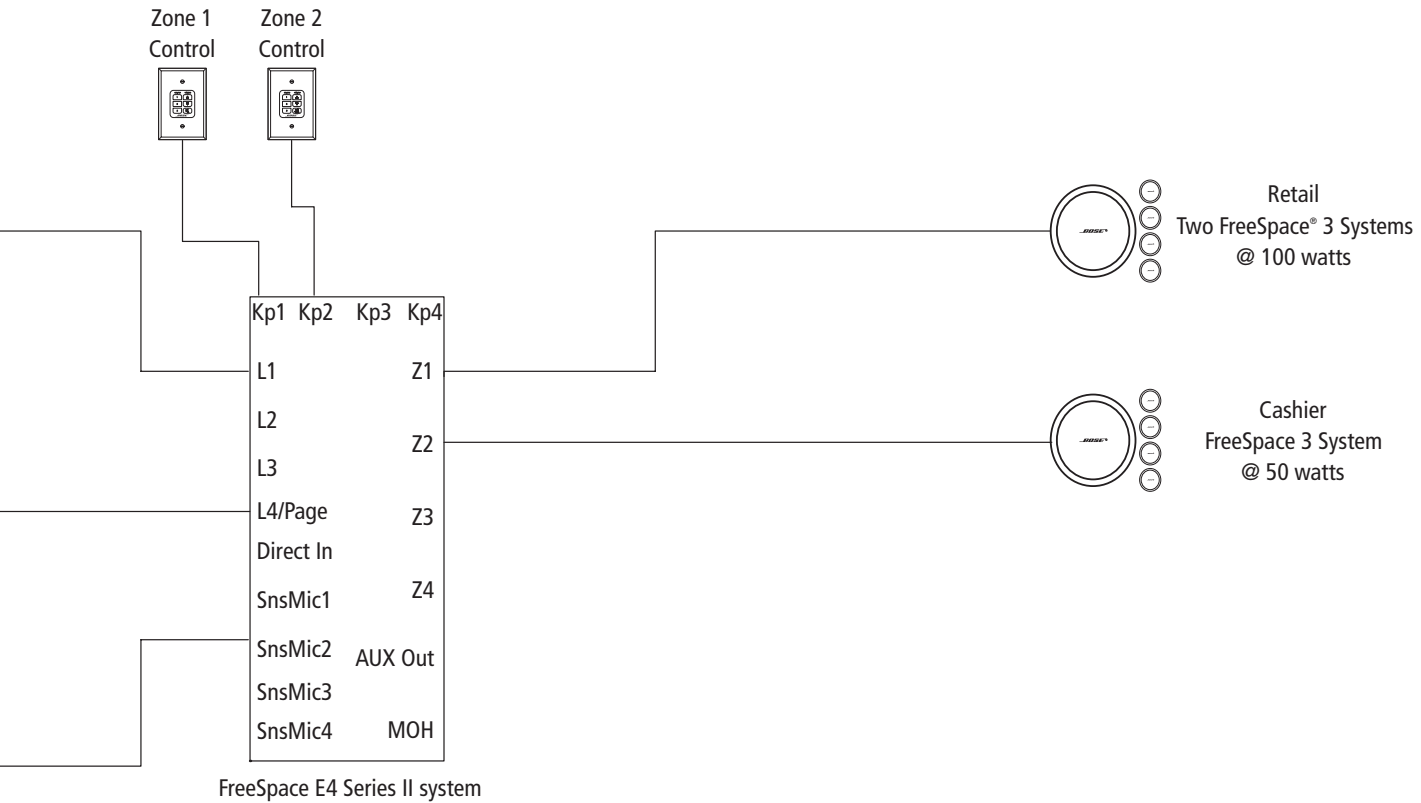

FreeSpace® Installer™ Software

FreeSpace Installer™ software is included with the E4 Series II system and is required for system setup and configuration.

System Requirements

Hardware:

- Minimum 200 MHz Pentium-based PC
- 128MB of free RAM
- 4x CD-ROM
- 60MB free internal hard disk space
- RS-232C port

Operating Systems:

- Windows® 98, Windows NT 4.0, Windows 2000, Windows ME

Display:

- 800x600 resolution, 16-bit color

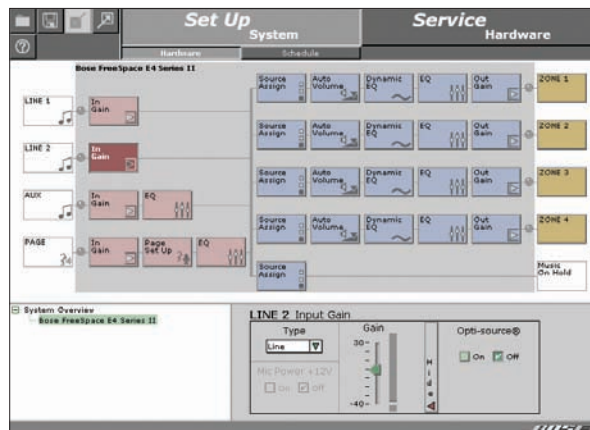

FreeSpace E4 Series II System Setup

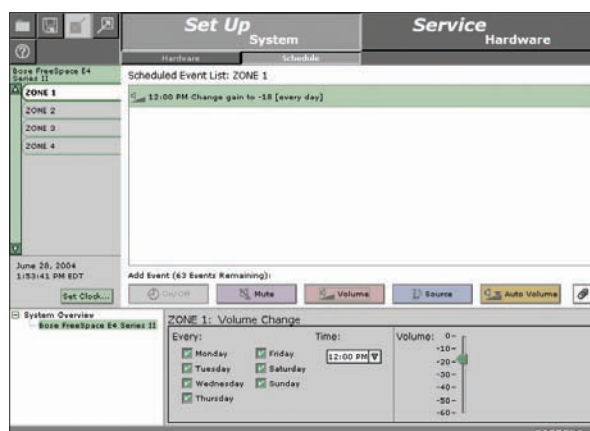

FreeSpace E4 Series II Event Schedule

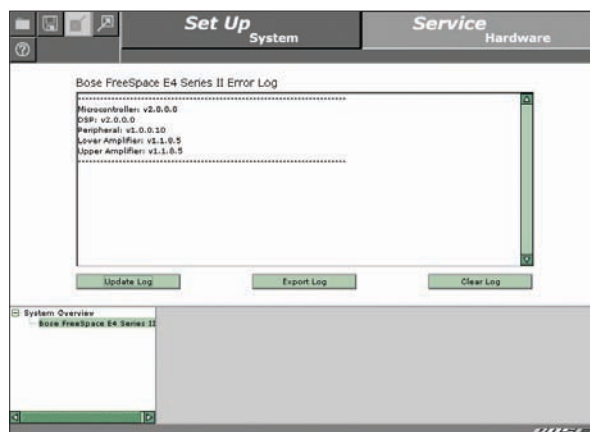

FreeSpace E4 Series II System Error Log

Architects' and Engineers' Specifications

The unit shall be an integrated signal processing and amplification system. The system shall use a digital signal processing architecture running at 44.1 kHz sample rate. The frequency response shall be from 20 Hz to 20 kHz, ± 1 dB. The signal-to-noise ratio shall be 90 dB or greater A-weighted.

The power amplification section shall deliver a maximum of 400W with less than 1.0% THD. Channel separation shall be >70 dB at 1 kHz.

The system shall consume AC power of 60W or less at idle, 300W at maximum continuous rated power.

The system shall perform the following processing functions:

- Input gain
- Input leveling
- Source routing
- Paging with adjustable ducking depth, hold and release time
- Automatic Volume control for each output zone
- Music on hold
- Three-band graphic equalization per zone
- Loudspeaker EQ for Bose® loudspeakers
- Output gain with Mute
- Loudspeaker protection limiting
- System diagnostics

The system shall be the Bose FreeSpace® E4 Series II.



Safety and Regulatory Compliance

The FreeSpace E4 Series II system complies with UL6500 2nd edition, EN60065 and IEC60065: 1998 (6th).



Limited Warranty

The FreeSpace E4 Series II system is covered by a five-year transferable warranty. Details of the warranty and its coverage are included in the FreeSpace E4 Series II Owner's Guide.

Literature

FreeSpace E4 Series II Technical Data PC036723
FreeSpace E4 Series II Brochure PC036724

How Our Products Are Measured

1. Amplifier Power

EIA Power – With the amplifier operating in 70V or 100V mode, a single channel is driven to full power with the minimum load impedance. Output power is measured using a 1 kHz sine wave with 1% THD, as measured at the amplifier output.

FTC Continuous – With the amplifier operating in 70V mode, any combination of channels are driven to full power with the minimum load impedance. Output power is measured using test signals between 20 Hz and 12 kHz with 1% THD, as measured at the amplifier output.

2. Signal-to-Noise Ratio

The output of the amplifier is connected to the rated load impedance with a unity gain of a frequency of 1 kHz. A dB-calibrated voltmeter is connected to the amplifier's output through an A-weighting filter (in accordance with IEC 60651). A 1 kHz signal is connected to one of the line inputs and the level is adjusted to achieve the amplifier's rated output power. The signal source is removed, and the line input is shorted. The dB-calibrated voltmeter now reads the A-weighted output noise level.

For more information, visit pro.bose.com