



ShowMatch™ DeltaQ™ Array Loudspeaker

Sub-Module Transition Kit Accessory: SMSTK

Safety Information



CAUTION: This product is intended for installation by professional installers only!

- Make no modification to system or accessories. Unauthorized alterations may compromise safety, regulatory compliance, and system performance.
- This accessory is intended for use with Bose ShowMatch DeltaQ Array loudspeakers only.



PRECAUCIÓN: Solo un instalador profesional deberá montar este producto!

- No realice alteraciones no autorizadas a este producto; esto podría comprometer la seguridad, el cumplimiento de las normas y el rendimiento del sistema.
- Este accesorio está diseñado para usarse únicamente con altavoces Bose ShowMatch DeltaQ Array.



ATTENTION: L'installation de ce produit est réservée à un technicien professionnel!

- Ne pas faire des modifications non autorisées à ce produit; ce qui pourrait compromettre la sécurité, la conformité réglementaire et la performance du système.
- Cet accessoire est destiné pour l'usage avec les haut-parleurs Bose ShowMatch Delta Q exclusivement.



ACHTUNG: Dieses Produkt darf nur von fachkundigen Monteuren installiert werden!

- Keine nicht autorisierten Veränderungen am Produkt vornehmen. Diese können die Sicherheit, die Einhaltung von Richtlinien und die Systemleistung beeinträchtigen.
- Dieses Zubehör ist ausschließlich zur Verwendung mit Bose ShowMatch DeltaQ Array Lautsprechern vorgesehen.

Additional Information

For additional information on ShowMatch DeltaQ Array loudspeaker modules and accessories, refer to the installation guide available at pro.bose.com. To request a printed copy, use the phone numbers provided.

Contact Information

Bose Corporation
Framingham, MA 01701 USA

Corporate Center: 508-879-7330
Americas Professional Systems,
Technical Support: 800-994-2673

Importer Information

China Importer: Bose Electronics (Shanghai) Company Limited, Level 6, Tower D, No. 2337 Gudai Rd. Minhang District, Shanghai 201100

UK Importer: Bose Limited Bose House, Quayside Chatham Maritime, Chatham, Kent, ME4 4QZ, United Kingdom

EU Importer: Bose Products B.V., Gorslaan 60, 1441 RG Purmerend, The Netherlands

Mexico Importer: Bose de México, S. de R.L. de C.V. , Paseo de las Palmas 405-204, Lomas de Chapultepec, 11000 México, D.F. For importer & service information: +5255 (5202) 3545

Taiwan Importer: Bose Taiwan Branch, 9F-A1, No. 10, Section 3, Minsheng East Road, Taipei City 104, Taiwan. Phone Number: +886-2-2514 7676

Limited Warranty

Your product is covered by a limited warranty, Visit pro.bose.com for warranty details.



772967-0020

©2022 Bose Corporation. All rights reserved.
Framingham, MA 01701-9168 USA,
www.pro.bose.com
All trademarks are the property of their respective owners
AM772967 Rev. 01
June 2022



ShowMatch™ DeltaQ™ Array Loudspeaker

Sub-Module Transition Kit Accessory: SMSTK

Installation Information

Thank you for selecting Bose® ShowMatch DeltaQ array loudspeakers. This document is intended to provide professional installers with basic installation and safety guidelines for using the Transition Bracket Accessory with ShowMatch DeltaQ array loudspeakers. Please read this document before attempting installation.



Use the ShowMatch DeltaQ Sub-Module Transition Kit Accessory (SMSTK) to build certain array configurations containing ShowMatch DeltaQ SM10 and SM20 full-range loudspeaker modules, and subwoofer modules (SMS118). The sub-module transition kit allows you to build certain array configurations without needing a second ShowMatch Array Frame (SMAF) between the subwoofer module and the top-most full-range module.



CAUTION: The ShowMatch DeltaQ Sub-Module Transition Kit Accessory is for use only with the array configurations specified in this installation guide. Do not use this accessory with any other configurations.

Product Dimensions

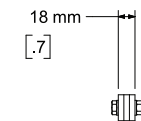
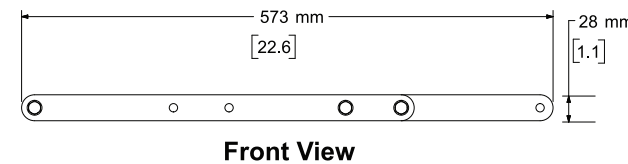
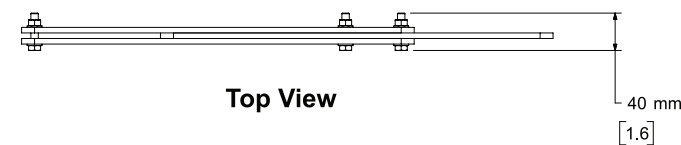

Right View
DIMENSIONS APPLY TO BOTH SIDES

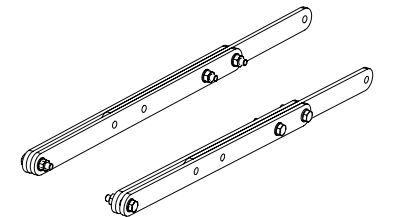

Sub-module transition kit

Single Point, 10:1 Working Load Limit

(in accordance with ANSI E1.8-2012)



ShowMatch Array Frame
Transition Bracket (SMSTK)
WLL = 110 kg (250 lbs)

Product Weight: 1.6 kg (3.6 lbs) per bracket assembly

Note: Must use TWO bracket assemblies per array configuration, one on each side of the array



Installation Instructions

To install the sub-module transition kit:

1. Determine correct position (short or long) for transition brackets, based on desired array configuration.
2. Assemble a stack of three bars as shown in Figure 3 (for short brackets) or Figure 4 (for long brackets). Each assembly includes one bar with a label, and two bars without a label. Assemble bars with label visible (facing outward). Repeat to create two assemblies.
3. Attach nuts and bolts on both brackets in locations shown in Figures 3 and 4. Tighten to 9 N-m (80 in-lbs).
4. Attach ShowMatch SM118 subwoofer module to hanging ShowMatch Array Frame (SMAF). For more information and assembly instructions, see ShowMatch DeltaQ Array Rigging Frames installation guide, available at pro.bose.com.
5. Attach front two connection points of first full-range module to front two connection points of subwoofer module, using included quick pins. Do not attach rear connection point of full-range module. For more information and assembly instructions, see ShowMatch DeltaQ Array Loudspeakers installation guide, available at pro.bose.com.
6. Attach remaining full-range modules to complete the array, using front and back connection points.
7. Attach ShowMatch Array Pullback Bracket (SMPULL) to bottom module of array. For more information and assembly instructions, see ShowMatch DeltaQ Array Rigging Frames installation guide, available at pro.bose.com.
8. Attach one transition bracket to each side of pullback bracket using provided nuts and bolts. Tighten to 9 N-m (80 in-lbs).
9. Using handles on rear of full-range modules, lift array into position until transition brackets reach the bottom, rear connection points of subwoofer module.
10. Attach transition bracket to the bottom, rear connection point of the subwoofer, using included quick pins. See Figure 5.



Fig. 1. Short bracket position

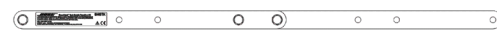

Fig. 2. Long bracket position

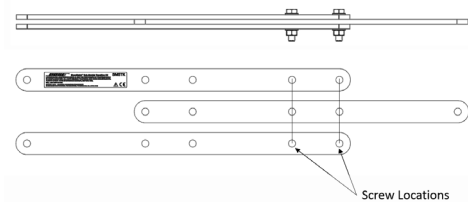

Fig. 3. Short bracket assembly

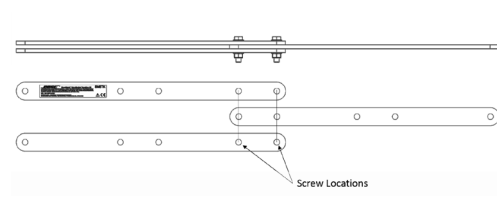

Fig. 4. Long bracket assembly

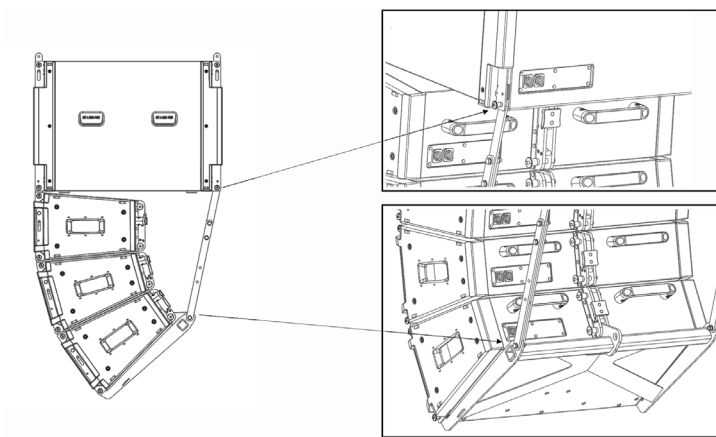

Fig. 5. Transition bracket connection points

Configurations Using Short Bracket Position

There are two allowable array configurations that use the short bracket position:

- SM10, SM20, SM20 (see Figure 6)
- SM20, SM20, SM20 (see Figure 7)

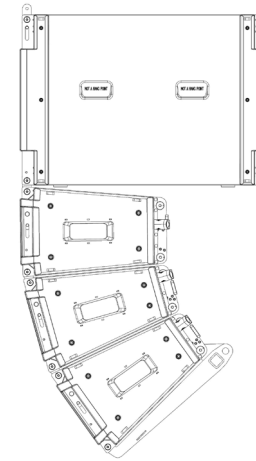

Fig. 6. SM10-SM20-SM20

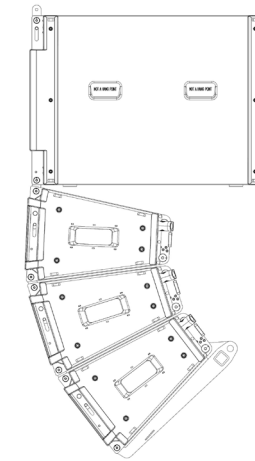

Fig. 7. SM20-SM20-SM20

Configurations Using Long Bracket Position

There are three array configurations that use the long bracket position:

- SM10, SM10, SM10, SM20 (see Figure 8)
- SM10, SM10, SM20, SM20 (see Figure 9)
- SM10, SM20, SM20, SM20 (see Figure 10)

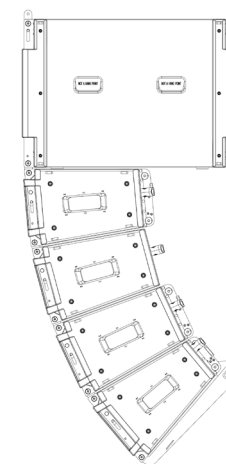

Fig. 8. SM10-SM10-SM10-SM20

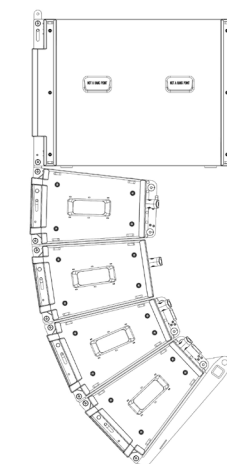

Fig. 9. SM10-SM10-SM20-SM20

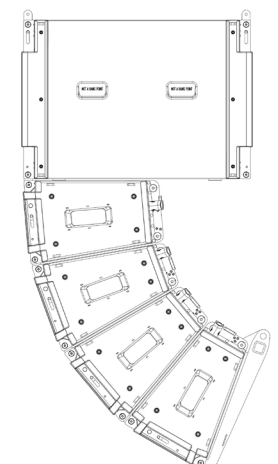

Fig. 10. SM10-SM20-SM20-SM20